

Oasys Ltd REPORTER Manual





For help and support from Oasys Ltd please contact:

UK

Tel: +44 121 213 3399

Email: dyna.support@arup.com

China

Tel: +86 21 3118 8875

Email: china.support@arup.com

India

Tel: +91 40 69019723 / 98

Email: india.support@arup.com

USA West

Tel: +1 415 940 0959

Email: us.support@arup.com

Web: www.oasys-software.com/dyna

or contact your local distributor.



REPORTER 23.0

Table of Contents

1. Title Page.....	10
2. Preamble.....	11
2.1. Introduction.....	11
2.2. Revision History.....	12
2.3. Text Conventions Used in this Manual.....	61
2.3.1. Typefaces.....	61
3. Themes for the Graphical User Interface.....	62
3.1. Setting the Theme.....	63
4. Setting Up and Running REPORTER.....	65
4.1. Setting Up REPORTER.....	65
4.1.1. Prerequisites.....	65
4.1.2. REPORTER Installation.....	65
4.2. Running REPORTER.....	66
4.3. A One Minute Introduction to REPORTER.....	67
5. Menu Layout.....	68
5.1. Basic Menu Layout.....	68
5.2. Mouse and Keyboard Usage for the Screen Menu Interface.....	74
5.2.1. Buttons.....	74
5.2.2. Text Boxes.....	75
5.3. Using The "File Filter" Boxes.....	76
5.3.1. Basic Unix File Filter Box.....	76
5.3.2. Basic Windows File Filter Box.....	77
5.4. Log File.....	78
5.5. View Controls.....	81
5.5.1. Item Visibility Options.....	81
5.5.2. Design/Presentation View.....	81
5.5.3. Assorted Options.....	82
5.5.4. Generation Order.....	82
5.5.5. Zoom.....	83
5.5.6. Full Screen View.....	83
5.6. Running a Script File.....	83
5.7. Preferences.....	85
5.7.1. Editing.....	85



5.7.2. Grid.....	86
5.7.3. Fonts and Colours.....	86
5.7.4. Date and Time.....	87
5.7.5. Library.....	88
5.7.6. App items.....	89
5.7.7. Startup.....	90
5.7.8. Accessibility.....	91
6. Opening and Closing Templates and Reports.....	93
6.1. Creating a New Template.....	93
6.2. Reading an Existing Template or Report.....	94
6.3. Reading a Library Template.....	94
6.4. Editing Template Properties.....	95
6.5. Saving a Template.....	96
6.6. Saving a Report.....	97
6.7. A Note on REPORTER's File Formats.....	98
7. Inserting and Editing Pages.....	99
7.1. Adding a New Page.....	99
7.2. Adding a New Page from the Library.....	101
7.3. Deleting Pages.....	103
7.4. Duplicating Pages.....	103
7.5. Reordering Pages.....	103
7.6. Changing the Current Page.....	106
7.7. Changing the Page Properties.....	106
7.8. Inserting Pages from File.....	106
7.9. Importing and Exporting Pages.....	107
7.10. Page Masters.....	107
7.11. Page Setup.....	107
7.12. Generating a Single Page.....	108
8. Inserting and Editing Simple Objects.....	109
8.1. Using the Grid and Snap Options.....	109
8.2. Setting Line Style, Thickness, Colour and Fill Colour.....	110
8.3. Inserting and Editing Shapes, Images and Text.....	111
8.3.1. Lines and Arrows.....	111
8.3.2. Rectangles.....	111
8.3.3. Ellipses and Circles.....	112
8.3.4. Text.....	112



8.3.5. Textbox.....	113
8.3.6. Images.....	114
8.4. Editing Shapes, Image and Text Objects.....	117
8.5. Copying Objects and Using the Clipboard.....	120
8.6. Reordering Items on the Page.....	121
8.7. Locking Items.....	124
9. Advanced Objects.....	125
9.1. D3PLOT Objects.....	125
9.1.1. Using Capture to Create a D3PLOT Object.....	128
9.1.2. Creating Multiple Images from a Single D3PLOT Session.....	132
9.1.3. Using Datafiles to Create 'Blob' Plots.....	134
9.1.4. Using a Command File to Create a D3PLOT Object.....	136
9.1.5. Editing D3PLOT Objects.....	137
9.2. T/HIS Objects.....	138
9.2.1. Using Capture to Create a T/HIS Object.....	140
9.2.2. Using Your Own FAST-TCF Script to Create a T/HIS Object.....	142
9.2.3. Using a Command File to Create a T/HIS Object.....	143
9.2.4. Editing T/HIS Objects.....	144
9.3. PRIMER Objects.....	144
9.3.1. Using Capture to Create a PRIMER Object.....	146
9.3.2. Editing PRIMER Objects.....	149
9.4. Program Objects.....	150
9.4.1. Text Output From a Program.....	150
9.4.2. Editing Program Objects.....	152
9.5. File Objects.....	152
9.5.1. Text Files.....	152
9.5.2. Image Files.....	154
9.6. Library Objects.....	155
9.6.1. Library Images.....	155
9.6.2. Library Program/Script.....	155
9.6.3. Editing Library Objects.....	157
9.7. Table Objects.....	158
9.7.1. Changing the Number of Rows or Columns in the Table.....	159
9.7.2. Using the 'Fix Overall Table Size...' Checkbox.....	160
9.7.3. Changing the Margins for Cells in the Table.....	161
9.7.4. Seeing what is in Each Cell.....	162
9.7.5. Changing Cells.....	163



9.7.6. Merging Cells.....	165
9.7.7. Cell Borders.....	166
9.7.8. Saving to CSV or XLSX.....	167
9.8. Autotable Objects.....	167
9.8.1. Selecting Variables Files for the Table.....	170
9.8.2. Setting the Header and Generated Row Heights.....	171
9.8.3. Adding Columns to the Table.....	172
9.8.4. Using the 'Fix Overall Table Width...' Checkbox.....	174
9.9. Script Objects.....	174
9.10. Script File Objects.....	176
9.11. Note Objects.....	177
9.12. Placeholder Objects.....	179
10. Undo.....	180
11. Search.....	182
12. REPORTER Integration.....	187
12.1. Linking the Programs.....	187
12.2. Item Tree.....	188
12.3. Capture.....	188
12.3.1. Capturing Movies.....	190
12.4. Reload.....	191
12.4.1. Reload Models.....	193
12.5. Generate.....	194
12.6. Variables.....	194
12.7. Exceptions to the Version 17 Method and Existing Templates from Version 16 and Earlier	196
13. Generating and Outputting Reports.....	197
13.1. Effect of Object Order on Generating a Report.....	197
13.2. Generating Reports.....	198
13.2.1. Using the Cursor in Presentation Mode.....	201
13.3. Outputting a Generated Report.....	201
13.3.1. Printing.....	203
13.3.2. PDF Files.....	205
13.3.3. HTML Output.....	206
13.3.4. PowerPoint Files.....	207
13.4. Combining Output from Multiple Reports.....	208
13.5. Multimedia Support for Output File Formats.....	208
14. Working with Variables.....	210



14.1. User Defined Variables.....	210
14.2. Predefined Variables.....	212
14.3. Formatting TIME and DATE Variables.....	212
14.4. Creating and Editing Variables.....	214
14.5. Creating a Variable Using D3PLOT.....	218
14.6. Creating a Variable Using T/HIS.....	219
14.7. Creating a Variable Using an External Program/Script.....	220
14.8. Creating a Variable Using a FAST-TCF Script.....	221
14.9. Creating a Variable from the Command Line.....	223
14.10. Creating a Variable from Javascript.....	223
14.11. Deleting Variables.....	224
14.11.1. Deleting a Variable.....	224
14.11.2. Deleting all Temporary Variables.....	224
14.12. Inserting a Variable.....	224
14.12.1. Manually Inserting a Variable.....	228
14.12.2. Controlling the Precision/Decimal Places of a Variable.....	229
14.13. Using Variables in D3PLOT and T/HIS Command Files and FAST-TCF Scripts.....	229
14.13.1. Command Files.....	230
14.13.2. FAST-TCF Scripts.....	231
14.14. Saving all the Variables to a File After Generating a Report.....	231
14.15. Variable Expressions.....	232
14.15.1. Rounding Values in Variable Expressions.....	234
15. Hyperlinks.....	235
15.1. Adding Basic Hyperlinks.....	235
15.2. Adding Hyperlinks in D3PLOT External Data (Blob) Plots.....	236
16. Conditional Formatting.....	238
16.1. Adding a Condition.....	238
16.2. Condition Types.....	241
16.2.1. Regular Expressions.....	242
17. Fonts.....	247
17.1. Supported Fonts.....	247
17.2. Legacy Fonts.....	249
17.3. Font Mapping.....	249
17.3.1. Font Substitution Dialog.....	250
17.3.2. Font Mapping Table.....	252
17.4. Fonts in Report Output.....	253



18. Scripting	255
18.1. JavaScript.....	256
18.1.1. ECMAScript 6 Modules.....	257
18.1.2. Example Scripts.....	259
18.2. Python.....	267
19. Workflows Updates	268
20. Timeout Control	274
21. Appendices	275
21.1. A. Command Line Arguments and oa_pref Options.....	275
21.1.1. Command Line Arguments.....	275
21.1.2. Oa Pref Options.....	277
21.2. B. Library Objects.....	289
21.2.1. Standard Library Programs.....	289
21.2.2. Standard Library Pages.....	298
21.2.3. Standard Library Images.....	298
21.2.4. Adding Pages to the Library.....	299
21.2.5. Adding Scripts to the Library.....	300
21.2.6. Adding Images to the Library.....	303
21.2.7. Standard Library Templates.....	303
21.3. C. FAQ.....	336
21.3.1. FAQ.....	336
21.4. D. Writing External Programs/Scripts.....	338
21.4.1. Returning Variables From Programs.....	338
21.4.2. Accessing Existing Variables in REPORTER.....	338
21.4.3. Example perl Program to Read Variables File from REPORTER.....	339
21.4.4. Example Program: Extracting the Smallest Timesteps (Text Output).....	342
21.5. E. Unicode Support.....	350
21.5.1. Unicode Support.....	350
21.5.2. Output Formats that Support Unicode.....	350
22. Installation Organisation	352
22.1. Oasys Suite 23.0 Installation Structure.....	352
22.1.1. Installation Examples.....	356
22.1.2. Dynamic Configuration Using the Top Level oa_pref File.....	358
22.1.3. The Hierarchy of oa_pref File Reading.....	359
22.1.4. Locking Preference Options.....	360
23. Licences Used in Software	361
23.1. Open source.....	362



23.1.1. Apple Public Source.....	362
23.1.2. Draco.....	362
23.1.3. Expat.....	363
23.1.4. FreeType.....	363
23.1.5. FFmpeg.....	366
23.1.6. HDF5.....	370
23.1.7. Jpeg.....	372
23.1.8. Libchardet.....	374
23.1.9. Libcurl.....	382
23.1.10. Libgif.....	383
23.1.11. Libopc.....	384
23.1.12. Libpng.....	384
23.1.13. Libxlsxwriter.....	387
23.1.14. Libxml2.....	391
23.1.15. Libzip.....	392
23.1.16. Openssl.....	392
23.1.17. PCRE2.....	396
23.1.18. PDFHummus.....	398
23.1.19. Schemasafe.....	399
23.1.20. SmoothSort.....	399
23.1.21. Spidermonkey.....	399
23.1.22. SQLite.....	410
23.1.23. TOML Parser for C.....	412
23.1.24. Treeview.....	412
23.1.25. Turf.....	414
23.1.26. Win-iconv.....	414
23.1.27. Zlib.....	414
23.2. Other.....	416
23.2.1. MPEG-LA.....	416
23.2.2. x264.....	416
23.3. Acknowledgements.....	417
23.3.1. POV-Ray.....	417



1. Title Page



Oasys LS-DYNA Environment Automated Post- Processing

	Driver	Passenger
Head and Neck Score	4.00	0.00
Chest Score	3.35	3.77
Knee, Femur and Pelvis Score	4.00	4.00
Lower Leg, Foot and Ankle Score	0.26	0.00
TOTAL (sum of each body region)	11.61	7.77
TOTAL SCORE	0.00	

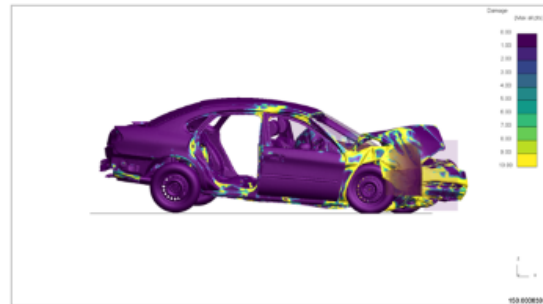
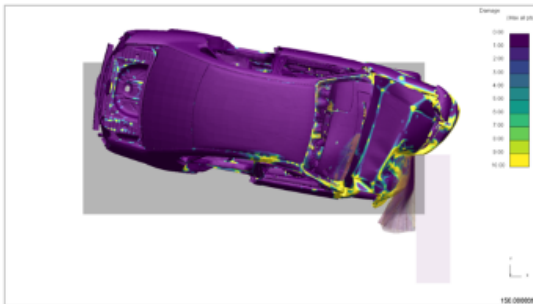
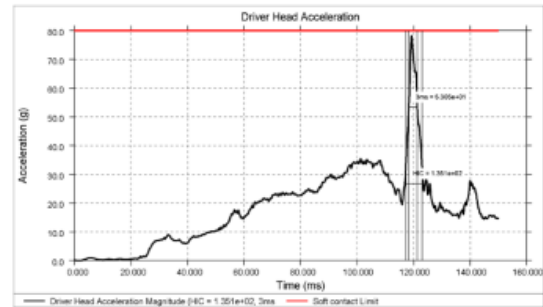

Version 23.0, Copyright Arup Digital Products Ltd, 2026
8 Fitzroy Street | London | W1T 4BJ

LS-DYNA, LS-OPT and LS-PrePost are registered trademarks of ANSYS, Inc.



2. Preamble

2.1. Introduction

Introduction

REPORTER is a tool to automate the post processing of Ansys LS-DYNA models. It allows you to create a standard template for a report. With command files and scripts it links with D3PLOT, PRIMER, and T/HIS, and other programs to create the necessary images and graphs when you come to generate an actual report from this template. It can also be run in batch mode so that when a model has finished being analyzed a report can be automatically generated according to a pre-built template.



Systems supported

REPORTER is available for Windows (64 bit) and Linux (64 bit).



2.2. Revision History

Revision History

Version 23.0

- You can now download the template thumbnail via the Edit Template Properties dialog, or via the Javascript/Python API. You can also now update the thumbnail with an image of your choice via the API.

Fixes enhancement 56970.

- Search functionality has now been added to the Main Window to enable finding relevant actions and submenus.

Fixes enhancement 50870.

- Search functionality has now been added to the Choose a Template and Choose a Page dialogs.

Fixes enhancement 42528.

- Search functionality has now been added to the Logfile dialog.

Fixes enhancement 52734.

- Sorting and search features have now been added to the Variables dialog.

Fixes enhancement 53524.

- Ctrl+D keyboard shortcut to duplicate a page has now been added.

Fixes enhancement 56740.

- Added a new preference that allows users to choose which frame of a MP4 will be used as the thumbnail when exporting to PowerPoint and PDF. Options available: CURRENT (default), FIRST or LAST.

Fixes enhancement 57506.

- Added validation of the job file when launching D3PLOT via the capture button. This prevents passing a non-existent job file and avoids displaying the D3PLOT invalid file information box.

Fixes bug 57759.

- REPORTER now asks which values to replace in a T/HIS linked session before replacing with a variable.

Fixes bug 54531.

- REPORTER now correctly handles spaces in the D3PLOT capture item's filepath.

Fixes bug 57379 and 57641.

- REPORTER will not crash when trying to insert Library Program items inside a table item.

Fixes bug 57954.

- The coloured tiles hover box in preference dialog for colours now has contrasting text and background colours for better readability.

Fixes bug 58288.

- REPORTER will now write images on the master page only once in the PDF file and use references elsewhere to reduce the final PDF file size.

Fixes bug 58524.



- REPORTER can now be configured to exit automatically after a specified duration. The timeout is controlled via the OASYS_TIMEOUT environment variable. Once the defined limit is reached, the applications terminate safely.
Fixes enhancement 55966.
- REPORTER can now be save reports using an existing PowerPoint template or append to an existing file. Slide layouts are automatically applied, with content scaled to fit.
Fixes enhancement 56983.
- REPORTER will not crash which occurs when trying to generate templates with large number of pages.
Fixes bug 58223.
- REPORTER fonts will always be displayed inside the table cell even when the descent height is 0.
Fixes bug 58476.

Version 22.1

- REPORTER now automatically wraps the selected job file path in quotation marks in the Edit D3PLOT dialog, ensuring compatibility with file paths that contain spaces.
Fixes bug 56756.
- REPORTER now updates the page thumbnails correctly for actions done and undone in the master page regardless of whether the current page is a master page or not.
Fixes bug 56663.
- The page navigation bar now scrolls automatically when dragging a page button to the top or bottom, allowing you to reorder pages beyond the visible area.
Fixes bug 55244.
- New pages will now, by default, inherit the background color from the master page. When editing page properties of the master page, the title field will now be disabled.
Fixes bug 55747.
- REPORTER now correctly saves the variables captured with your T/HIS graphs to the report/template.
Fixes bug 57044.
- REPORTER now updates the page thumbnails properly when a script is not executed correctly on load.
Fixes bug 57025.
- When linked with PRIMER, D3PLOT or T/HIS, REPORTER would sometimes send the same command twice in a row. When generating an item or entire document, this could lead to the other program failing to revert to its previous state prior to generation and instead flushing all models and data from memory to appear like a fresh session. This has now been fixed so the commands are not incorrectly issued twice and PRIMER, D3PLOT and T/HIS will correctly revert to the state they were in before generation.
Fixes bug 56832.



- REPORTER no longer exits from the master page when you paste an item into it. Fixes bug 57194.
- REPORTER now displays the correct capture type in the Edit D3PLOT item dialog when you capture over a D3PLOT item of type 'Blank'. Fixes bug 57196.
- The scroll wheel now allows intra-page scrolling. If you are at the bottom or top of the page, using the scroll wheel will jump to the next or previous page, respectively. Fixes bug 56816.
- REPORTER no longer crashes when you write a T/HIS item to PowerPoint. Fixes bug 57223.

Version 22.0

- The page navigation bar now updates correctly when you traverse your report/template by selecting items via the REPORTER item tree in D3PLOT and T/HIS. Fixes bug 56023.
- The logic for drawing rectangles and ellipses when holding the Shift and/or the Ctrl keys has now been improved. Fixes bug 56017.
- The page thumbnails in the page navigation bar now update automatically when you change the grid visibility. Fixes bug 56119.
- The spinbox used to specify a variable's precision has now been made larger to ensure visibility of its value. Fixes bug 56015.
- The Category and Value drop down lists in the "Edit Template Properties" menu will now have sorted items. Fixes bug 56063.
- The text on script buttons will now have a more appropriate font size of 8 pts. Fixes bug 52190.
- The new features buttons on the splash screen dialog will now point to the correct pages in the new features pdf. Fixes bug 54102.
- When creating/opening a template, the REPORTER icon will no longer be duplicated in the top left corner of the main window. Fixes bug 55880.
- REPORTER can now identify report/template variables more accurately and makes sure to account for any formatting strings following the variable name. Fixes bug 54335.
- The REPORTER JavaScript and Python APIs now feature a new property "generating" for the template, page and item objects. Fixes bug 55883.
- REPORTER will now attempt to write the logfiles in case of a crash. If no log file command argument has been provided, these will be written to a reporter.error



file. It will also attempt to print a stack trace in the logfile on Linux when REPORTER is run in batch mode.

Fixes bug 55853.

- REPORTER "Oasys items" are now referred to as "App items".
Fixes bug 55595.
- The logic for reordering pages by dragging and dropping page navigation thumbnails has now been improved.
Fixes bug 55749.
- REPORTER now properly handles any modifications (creation and deletion) to your captures via the old method whenever you create or convert to a new D3PLOT item.
Fixes bug 55723.
- REPORTER now makes it easier to report crashes on Windows, by pre-populating an email with stack trace information for you.
Fixes enhancement 55677.
- REPORTER now includes undo and redo functionality for most actions, providing the ability to correct mistakes and return to previous states easily. An undo history view is also available, allowing you to easily navigate through previous states within your session. The undo stack will be cleared whenever you generate or run scripts.
Fixes enhancements 50876, 37443, 15478, & 8997.
- REPORTER no longer crashes when you convert to the new capture method after editing the existing captures of your D3PLOT item.
Fixes bug 55555.
- Picking a screen colour now works when picking from another screen.
Fixes bug 52237.
- Support for different DPI displays has been improved. Menus will now scale more appropriately with changes in resolution and scale.
Fixes bug 55478.
- The Window::GetNumber() function from the API will now display the correct GUI theme for the number field.
Fixes bug 55486.
- If, in the Font Substitution Dialog, you choose to make the same replacements for other templates opened during the session, the option to preserve the original fonts and styles when saving the template will also apply to all templates.
Fixes bug 55636.
- Changes made in the "Edit D3PLOT Dialog" or "Edit T/HIS Dialog" before capturing will now correctly be loaded in D3PLOT and T/HIS.
Fixes bug 55682.
- When opening REPORTER files with items missing a font name, a warning will be logged and a default font name will be assigned.
Fixes bug 55483.
- When first opening REPORTER, the 'Choose a Template' dialog box will no longer load duplicated tabs if you open and close it several times in quick succession.
Fixes bug 55674.



- REPORTER handles invalid files better when trying to import an item into the template.
Fixes bug 55518.
- Unicode characters are now correctly rendered in the JavaScript API.
Fixes bug 55648.
- REPORTER no longer crashes when deleting a page using the right-click menu of the page navigation buttons.
Fixes bug 55569.
- REPORTER now correctly displays the generation order number of items on the master page.
Fixes bug 55570.
- There is now better error handling for importing invalid files into REPORTER.
Fixes bug 53055.
- We now support .ortx and .orrx file formats when importing a page into your current template/report.
Fixes bug 53104.
- The page thumbnails in the page navigation bar now update automatically when you capture from D3PLOT, T-HIS, and PRIMER.
Fixes bug 55374.
- Improved the way optional arguments are handled in the Python and JavaScript APIs.
Fixes bug 53910.
- Previously when closing REPORTER while having multiple unsaved templates open, if you chose to cancel the operation, REPORTER will remain open but the dismissed templates will also remain behind as separate windows. This has now been fixed.
Fixes bug 55235.
- REPORTER will no longer crash if the reporter_library folder contains no templates/pages or if it contains invalid files.
Fixes bugs 55062 & 55063.
- The filtering of the "Choose a Template" and "Choose a Page" dialog boxes is now fixed and works more intuitively.
Fixes bug 53841.
- The options in the filters tree of the "Choose a Template" and "Choose a Page" dialog boxes will always be visible now, regardless of machine resolution and scale.
Fixes bug 53630.
- After setting the job file of a T/HIS item as empty, reopening the T/HIS Edit Dialog would previously restore the empty job to the default value. Now, it will remember the empty job file.
Fixes bug 47783.
- The Item.RemoveCondition method has been added to REPORTER's JavaScript and Python APIs to allow you to remove any conditions that have been set to items. Also, providing a name is now mandatory when creating conditions.
Fixes enhancement 54431



- REPORTER now supports ES6 modules, which give JavaScript built-in support for modular programming using the import and export keywords. REPORTER also now accepts the "-js" and "-js_arg" command line arguments for running JavaScript scripts with arguments.
Fixes enhancement 54255
- Positioning of dialog boxes should exhibit a more predictable behaviour now, where they are either centred relative to their parent dialog box or relative to the mouse release point.
Fixes bug 53765
- The "QThreadPipe: internal error" message no longer gets printed to the command line when you open a PDF on Linux.
Fixes bug 54152
- The Del key functionality has now been enhanced in REPORTER. If any items are selected on the template, pressing the Del key will delete those items (existing behaviour). However, if you navigate between pages using the page buttons in the page navigation bar and haven't interacted with the template, pressing the Del key will delete the current page. A faint border will appear around the page button to indicate that the Del key will delete this page.
Fixes enhancement 52652
- The thumbnails for the page buttons in the page navigation bar now update more efficiently when switching between design and presentation views in REPORTER.
Fixes enhancement 53897
- The page buttons in the page navigation bar now have a new right-click menu option that allows you to edit the page properties.
Fixes enhancement 54626
- REPORTER now displays the page number and title underneath the page button in the page navigation bar and as a tool tip whenever you hover over the button.
Fixes enhancement 52803

Version 21.1

- REPORTER can now create a combined report from ".orrx" files, in addition to ".orr" files.
Fixes bug 55278.
- REPORTER now correctly accounts for any line breaks present in variables when expanding them in D3PLOT item command files.
Fixes bug 54328.
- You will no longer be able to interact with the REPORTER window while saving a pdf, pptx or html file.
Fixes bug 55137.
- Inserting a new column in a Table item will no longer cause font issues in unrelated cells.
Fixes bug 55157.



- The page navigation bar now scrolls to the correct page when you add, duplicate, or delete a page in REPORTER.
Fixes bug 52564.
- Conditions will now also work with empty input text and empty comparison text.
Fixes bug 54750.
- REPORTER will no longer crash in the situation when a script item being generated deletes the page or closes the template it lives on. Instead, the generation of the item will stop and an error will be raised.
Fixes bug 54760.
- The Unix() and Windows() functions have now also been added to the REPORTER JavaScript and Python APIs.
Fixes enhancement 54928.
- If you save the report/template while on the master page, REPORTER will no longer exit the master page after saving.
Fixes bug 53597.
- The JavaScript API function Template.EditVariables now accepts the constant Variable.PRECISION for its columns input argument. Previously, it was not registering it as a valid input argument.
Fixes bug 53927.
- REPORTER no longer crashes if you close it while the library templates are being scanned.
Fixes bug 54727.
- REPORTER now updates the page thumbnails after editing or formatting an item.
Fixes bug 54832.
- When generating a D3PLOT item using the new capture method, REPORTER previously reverted to the old capture method if the D3PLOT item lacked capture data. Now, REPORTER will throw an error and stop the generation process instead.
Fixes bug 47533.
- Opening the Template Properties dialog in an instance of REPORTER where the Choose a Template dialog has not been shown yet (e.g. when REPORTER is opened in batch or iconised) will no longer cause a crash.
Fixes bug 54686.
- The template keyboard shortcuts (e.g. "P" key, PageUp key, "PageDown" key, etc.) no longer get deactivated when you interact with the Page Navigation bar and the Tools bar.
Fixes bug 54432.
- The Hyperlink menu no longer prevents the Page Navigation bar and the Design menu from expanding; it can now be expanded as well.
Fixes bug 54613.
- The JavaScript and Python API Item method GetCellProperties would previously crash REPORTER when used on an autotable item. The documentation has now been fixed to indicate that this method is only valid for normal table items and the program will now raise an error if used on any other item type.
Fixes bug 53909.



- The JavaScript and Python API Image object constructor will now require positive, non-zero width and height arguments. Previously, the constructor allowed optional width and height arguments, which would result in a null image. This null image prevented the use of any image methods and setting the width and height.
Fixes bug 53926.
- Duplicating a page, generating a page or importing an item onto a page via the JavaScript and Python APIs will now set the template corresponding to that page as active.
Fixes bug 54699
- It will no longer be possible to access the menus and toolbars in REPORTER while a template/report is loading. This will prevent unwanted behaviour since the menus will not be properly processed until the loading is complete. The "Select All" and "Deselect All" options in the "Edit" menu will now also appropriately enable or disable the corresponding "Edit" menu options like "Copy", "Cut" and "Delete".
Fixes bug 53561
- REPORTER now automatically updates the thumbnails of the page navigation buttons in the following scenarios: deleting items, pasting items, and moving items using the arrow keys. Also, when you press on script button in presentation mode, REPORTER will update all the pages that have been affected by the generation of this script item.
Fixes bug 53537
- The "Choose a Template" dialog and the splash screen will no longer be shown when starting REPORTER with the "-batch" or "-iconise" command line arguments.
Fixes bug 53867
- When opening a table item to edit it, the first cell will no longer be selected by default. When deselecting and then reselecting the same cell, the focus will now correctly be on the line edit to allow you to edit it.
Fixes bug 54334
- REPORTER now correctly expands any variables present in command files associated with D3PLOT items. Previously, REPORTER could not expand these variables if their names contained special characters such as '-', '@', etc.
Fixes bug 54268
- The "Generate page", "Generate items" and page navigations buttons are now disabled if the master page is the currently enabled page. This will prevent incorrect behaviour if new pages are created from scripts on the master page.
Fixes bug 54155
- REPORTER now properly exits the master page when you generate the template or report from the master page.
Fixes bug 54192
- REPORTER no longer crashes when you duplicate a page using the JavaScript API.
Fixes bug 54154



- REPORTER no longer crashes when you drag and drop a page button to the last position in the page navigation bar.
Fixes bug 54389
- REPORTER now properly toggles the correct page button in the page navigation bar when you delete a page using the 'Delete page' button in the top toolbar.
Fixes bug 54153

Version 21.0

- There is a small number of fonts available in REPORTER for which certain characters/symbols cannot be written to PDF. In this case, a warning will be recorded in the Logfile to inform you which font it is.
Fixes bug 53462
- The 'Edit Template Properties' dialog box is no longer duplicating entries in the drop down menus every time it is re-opened.
Fixes bug 53584
- To make the most out of the newly introduced Python API, REPORTER now allows you to create a gRPC server connection from both the command line via "-grpc" and from the Script menu.
Fixes enhancement 52123
- When capturing from D3PLOT or T/HIS, the default names for the variables associated with the capture are now derived from their corresponding REPORTER Oasys item names.
Fixes bug 52900
- When importing a template or a report, REPORTER now lets you choose what happens with the incoming master page. You can merge the master page into your current master page, overwrite your current master page with the incoming one, ignore the incoming master page or cancel the import.
Fixes bug 53107
- You can now set your preferred PDF and HTML applications through REPORTER's preferences dialog. These preferences will allow you to choose the application that will be launched when opening a PDF or HTML file from REPORTER.
Fixes bug 52153
- Duplicating a page or copy-pasting an item will no longer change the new item's image filename to the default %DEFAULT_DIR%/DEFAULT_JOB%_image00X.png. Instead, the new item's image filename will be derived from the original one.
Fixes bug 52802
- If any of REPORTER's default generic fonts are unavailable on your machine, REPORTER will automatically attempt to substitute them with an alternative font within the same generic category.
Fixes bug 53402
- The reporter*maximise preference now works not only for the main window, but also for the 'Choose a Template' dialog and 'Choose a Page' dialog as well.
Fixes bug 49585
- Previously, drop-down menus on Linux would display top and bottom scroll arrows regardless of the size of the list, obscuring the item names. Now the



drop-down list will be displayed without arrows, with item names fully visible.

Fixes bug 47886

- When opening the variables menu in a new template, the "When generating save variables to directory" option will be disabled by default. This is to prevent frequent issues with autotable generation where it would save its own reporter_variables file and read from it.

This change would not apply to existing templates that were generated with versions <21.0.>

Fixes bug 42430

- REPORTER now features enhanced page navigation functionality with the introduction of a new page navigation toolbar. Page thumbnails are displayed for the current template or report. Using this page navigation toolbar, you can navigate between pages by clicking the relevant page thumbnail. Right-clicking the page thumbnails allows you to execute context menu actions such as deleting, duplicating and adding pages. Additionally, you can now re-order the pages in the template or report by dragging and dropping the page thumbnails to change their order. The page thumbnails update dynamically when you interact with the template.

To accommodate the new page navigation toolbar, the Tools toolbar has been relocated to the right, creating two tabs: (1) the Tools tab, and (2) the Format tab. The Format tab becomes visible when an item in the template or report is selected.

Fixes enhancement 50875.

- D3PLOT items in REPORTER now have two extra options: (1) pre-blank the D3PLOT model before reading the properties file, and (2) ignore elements when reading the properties file. These options are originally preferences, and still are, but are now also per-item options. Since these options are now part of the report or template, using them will ensure similar captures when the report or template is shared with users that do not have the corresponding preferences set. If you open a version 21 and above template or report, the preferences are ignored and the per-item options are honoured. If you open a version 20.1 and below template or report, the preferences are only honoured as long as none of the two options are selected in the D3PLOT dialog.

Fixes bug 45398.

- REPORTER now always shows the 'Generate' option in the context menu whenever you right-click on selected item(s) in the template or report. REPORTER previously removed this option if any of the selected items do not change when generated.

Fixes bug 50750.

- New preferences are available to control the Library and Workflows directories scanned for templates, pages and scripts when REPORTER opens. By default, REPORTER will scan all of the directories listed. If you check "Only this" in the Preferences dialog, REPORTER will scan only the specified Library or Workflows directory, and none of the directories above it (Library and Workflows are treated separately via reporter*library_only_use_specified_directory and oasis*workflow_only_use_specified_directory). This allows you to switch



REPORTER to use a different directory when you customise the templates provided with the installation, or when you receive an updated bundle of templates from Oasys Ltd.

In addition, when REPORTER scans Library and Workflows directories for templates and pages, it now scans subdirectories recursively. The scripts directory is not scanned recursively.

Fixes enhancement 52769.

- The Choose Template and Choose Page dialogs now show the filename of the selected template or page next to the title and description. This can help clarify the location when multiple Library or Workflows locations have been specified in preferences.
Fixes bug 53480.
- REPORTER opens HTML and PDF files to give you access to documentation and additional user guides. REPORTER now uses the same logic to open these files as PRIMER, D3PLOT, T/HIS and SHELL. This fixes an issue where PDF files sometimes failed to open on Linux. You can now specify your preferred HTML and PDF applications via the REPORTER preferences, `html_application` and `pdf_application`.
Fixes bugs 47090, 49584, and 50731.
- Previously, when you opened a template or report that contained fonts that were unavailable on your system, you were prompted to select font substitutions. However, when you imported a page, you were not prompted and REPORTER would revert any unavailable fonts to an arbitrary system font. REPORTER now asks you to choose font substitutions whenever you open templates or reports or import pages with unavailable fonts. A new option in the font substitution dialog allows you to remember your substitution choices and automatically make the same substitutions to future templates, reports and pages opened within the same REPORTER session.
Fixes bug 51340.
- Fixed an issue that could cause the titles of templates and pages in Choose Template and Choose Page dialogs to become truncated on buttons.
Fixes bug 50312.

Version 20.1

- REPORTER now maps to an available font when launched. This ensures that an available font is used when creating an item via a script without explicitly specifying a font. This also avoids an unavailable font being requested when exporting the report/template as a PDF.
Fixes bugs 51624 and 51661.
- REPORTER now checks and updates the font style of an item if its font or font style has been changed via a script. If the font has been changed, then an available font style is set if the current one is not available. If the font style is changed, then REPORTER verifies its availability before applying it.
Fixes bug 51891.



- Fixed an issue that would cause button scripts to be generated despite having "do not run when template or page is generated" checked, if they existed in a template after a previous Script item that called Template.Generate().
Fixes bug 52026.
- D3PLOT and T/HIS X Server errors are now printed to standard output if the program is running in batch mode, otherwise the errors are printed to standard error. This makes sure that the batch process is not interrupted when running REPORTER in batch mode.
Fixes bug 52239

Version 20.0

- Alongside REPORTER 20.0 is the launch of Report Viewer (<https://oasysreportviewer.com>), a brand-new 3D web viewer for Ansys LS-DYNA results.
Fixes enhancement 30943.
- New file formats have been introduced for REPORTER; '.ortx' for Templates and '.orrx' for Reports. Using these formats, it is now possible to save multimedia content like MP4 (and the newly-added GLB) within your Templates and Reports. The older '.ort' and '.orr' formats have been marked as '[LEGACY]' and may be removed in a future release.
Fixes enhancement 50120.
- D3PLOT Items have been updated to support the capture of 3D GLB content from D3PLOT to REPORTER. GLB content is displayed using a static image in REPORTER itself but can be viewed properly using Report Viewer (and the GLB files created in the job destination can be viewed individually using D3PLOT Viewer). When using the GLB (Current frame, Uncompressed) option, exporting to PowerPoint is also supported.
Fixes enhancement 50124.
- Added the new .ortx and .orrx file formats to the Oasys Suite installer so that REPORTER 20.0 can be registered as the default application for opening these types of files.
Fixes enhancement 49981.
- REPORTER now honours the user-defined start-in directory during file selection when a session is first opened. When subsequent file selections are required, REPORTER uses the retained information about the most recently used directory to help direct the user in browsing.
Fixes enhancement 10685 and bug 50330.
- Added support for the oasys*workflow_definitions_directory oa_pref option to REPORTER. This preference can be used to point to a user-defined workflows directory. Any Templates/Pages contained in a templates/pages subfolder of the workflows directory will be added to REPORTER's list of library templates/pages on startup.
Fixes enhancement 49969.
- REPORTER now automatically adds any missing extensions to file names when the user is saving a new file from REPORTER. The user's selected file filter will be



used to add the appropriate missing extension.

Fixes bug 50434.

- After navigating to a new page in REPORTER, the playback speed of animated items is now updated to match the current value shown in the animation toolbar.

Fixes bug 50982.

- A new standard page size, "PowerPoint slide (Widescreen)", has been added. This new size is 338.7 x 190.5 mm and matches the "Widescreen" slide size available in Microsoft PowerPoint since 2013. It has the same 16:9 aspect ratio as the older, smaller "PowerPoint slide (16:9)" size (254.0 x 142.9 mm), which is referred to as "On-screen Show (16:9)" in Microsoft PowerPoint. The new "Widescreen" size should make it easier to create reports that match the latest PowerPoint content.

Fixes enhancement 49043.

- Automotive and ICFD Library templates that process D3PLOT items will now automatically locate FEMZIP results files (Zd3plot, *.fz) in the results directory you specify.

Fixes enhancement 50192.

- Added the ability to toggle the 'Active' status of an Item through the right-click context menu. Items which are 'Inactive' cannot be Generated.

Fixes enhancement 37394.

- Two new Library Programs have been added: one to delete all temporary variables, and another to reset all temporary variables to a specified value (default being to reset to an empty string).

Fixes enhancement 49016.

- The Automotive library templates allow you to process results located in a different directory from your keyword file (to accommodate HPC clusters with this configuration). However, the D3PLOT items in several templates were found to be lacking this feature, and would throw an error unless the results were in the same directory as the keyword file. This has been fixed for the following templates:

- Euro NCAP Far Side Impact 2022
- Euro NCAP Side MDB 2022
- Euro NCAP Side Pole 2022
- IIHS Side MDB 2021
- IIHS Side MDB 2021 Structure Only

Fixes bug 50089.

- When mapping fonts, if the default font is not available for a generic type (sans-serif, serif, etc.) then REPORTER now searches for the first available font of the same type before switching to the default sans-serif as a last attempt.

Fixes bug 48794.

- If you insert a variable that does not exist in the report/template, REPORTER will now only log one error when the report/template is generated. REPORTER will no longer log an error when failing to render the missing variable in Presentation view.

Fixes bug 49982.



- When exporting a template to a report, the REPORTER session will no longer update (i.e. the session remains as the current .ort/.ortx).
Fixes bug 49174.
- When writing to PPTX, PDF, or HTML, REPORTER will return to the original page once finished.
Fixes bug 45690.
- The following scripts have been deprecated in REPORTER 20:
pedestrian_zone_area_from_csv.js and pedestrian_zone_area_from_variables.js.
It is recommended to use the HIC Area Calculator in PRIMER and the Euro NCAP and GTR Head Impact templates in REPORTER instead.
Fixes bug 50349.
- When modifying a PRIMER, D3PLOT, or T/HIS Item in REPORTER, the file browser launched by the Choose button for the Image File field will now allow for the creation of a new file. Previously, only an existing file could be selected.
Fixes bug 49468.
- Fixed an issue introduced in 19.1, in which a user-defined 'Image File' filename for a new PRIMER/D3PLOT/T-HIS Item was being overwritten by a default name when first creating the Item.
Fixes bug 49570.
- In rare circumstances following modification of the OA_INSTALL environment variable, it was possible for the 'New Library Page...' Dialog to prompt a crash to desktop. This is no longer the case.
Fixes bug 50054.
- REPORTER will now ignore any environment variable whose name includes non-word characters. Previously, REPORTER incorrectly allowed a sequence of non-word characters at the beginning of an environment variable name. This meant that '#OA_HOME' (for example) would have been interpreted as 'OA_HOME', leading to unexpected consequences for users.
Fixes bug 50317.
- When saving a Template to a new location using the 'File -> Save As' option, the 'Read-Only' label will no longer persist incorrectly in the REPORTER title bar.
Fixes bug 50448
- When duplicating a page, items on the new page would sometimes be located at incorrect coordinates. This could occur if a user had previously copied an item to the clipboard and right-clicked somewhere on the current page without then pasting the item. This issue should now be resolved.
Fixes bug 50983.

Version 19.1

- In REPORTER linked to D3PLOT or T/HIS v19.0 and earlier, if user resized an item in REPORTER by dragging the item box and then pressed Resize in D3PLOT / T/HIS then the window / graph would be resized to the original REPORTER item size, not the dragged size. This has been fixed.
Fixes bug 47202.



- Fixed an issue where 'Unlocked' Items were being accidentally switched to 'Locked' without a request from the user. This could occur when using multiple selection to select a group containing both 'Locked' and 'Unlocked' Items. Fixes bug 48958.
- Modified the behaviour of Oasys items on copy and paste, such that the new 'pasted' item is assigned a unique default filename in the 'Image file' field. Previously, the filename would be identical to that of the 'copied' item. This would result in the two items writing to the same location on Generate, which is very rarely intended. Fixes bug 48222.
- The 'Missing image' warning popup will now only be displayed once-per-template, listing all Image items for which an image could not be loaded. Fixes bug 45735.
- When updating an MP4 or GIF Capture for a D3PLOT Item, the Movie file path (for Generated output) was sometimes being accidentally replaced with a default path. This should no longer happen. Fixes bug 48664.
- REPORTER now supports Unicode text in PDF outlines (bookmarks) and the HTML index. This means that if you include Unicode characters in your REPORTER page titles, they will now appear correctly when you write a PDF or HTML file. Fixes bug 43983.
- Custom user colours that have been removed from all user_colours.xml files will no longer incorrectly appear in the 'Select Color' panel in REPORTER. Fixes bug 49364.
- Corrected issues introduced to a number of Library Program scripts in REPORTER 19.0 that were preventing them from running. Fixes bugs 49239 and 49399.

Version 19.0

- Support for high-DPI displays has been improved. Text, icons, and widgets should now scale up in size appropriately when REPORTER is used with a high-DPI display. Windows Display scaling settings are respected for integer values. Fixes bugs 43343 and 45645.
- Now, when you open a template in REPORTER, if the saved values of DEFAULT_DIR and DEFAULT_JOB are empty or default, and if REPORTER was launched from D3PLOT or T/HIS in a linked session, then the values of DEFAULT_DIR and DEFAULT_JOB are updated to match the path and filename of the current model open in D3PLOT or T/HIS. This means that when capturing items from D3PLOT and T/HIS into templates, the variables will be used in place of hardwired paths (previously you would have had to edit those manually). This makes it easier to run the template on multiple different models. Fixes enhancement 44209.



- Drive mapping support has been added to REPORTER and can be controlled using the `oasys*drive_? oa_pref` settings.
Fixes bug 16728.
- We have improved the handling of errors and warnings when generating content in REPORTER. Previously, you had to decide whether to stop generating the report before being able to see the error message. Now, you get to examine any errors and warnings before deciding whether to proceed.
When generating a report, if an error is encountered, the Logfile window will now appear immediately. This gives you the opportunity to examine the error before choosing whether to 'Stop', 'Continue' (Logfile will reappear if another error occurs), or 'Continue to end'.
You can now navigate up and down through the errors and warnings in the log file using the controls provided.
You can prevent the Logfile window from appearing when an error occurs by unchecking 'Check for errors during report generation'. In this case, you will still be asked at the end of generation if you would like to inspect the log file.
Also, the following options are now automatically saved to your REPORTER preferences upon selection:
 - Include debug information from PRIMER, D3PLOT, and T/HIS
 - Don't automatically exit from PRIMER, D3PLOT, and T/HIS
 - Check for errors during report generationFixes enhancement 39802.
- When an error occurs during report generation, or when a Script item calls `Window.GetOptions`, the Logfile or options window is now brought to the front of your display (or the icon on the taskbar will flash, depending on what is permitted by your operating system). This helps notify you that action is required, especially when a PRIMER, D3PLOT or T/HIS session may have been launched in front of REPORTER, temporarily obscuring it.
Fixes bug 43178.
- Unlike PRIMER, D3PLOT and T/HIS, REPORTER does not support the Use function, or JavaScript modules. To help address this, a new "Script File" item has been added to REPORTER. Script File items have all the features of Script items, except that rather than containing an embedded JavaScript, they point to an external script file. This allows you to edit the script in your preferred editor.
Furthermore, since the REPORTER JavaScript environment persists for the duration of the REPORTER session (and is shared by all scripts), you can now create one or more Script File items containing any common functions, followed by one or more Script File items that use those functions. This should provide much of the benefits of the Use function and JavaScript modules available in PRIMER, D3PLOT and T/HIS.
Fixes enhancement 47275.
- When converting an item from one type to another, it is now possible to preserve the the item's name.
Fixes bug 46932.
- Previously, setting the font property of an Image object to a font family name that was not available in REPORTER would result in an exception being thrown.



Now, the font name is mapped to the best available match in REPORTER.

Fixes bug 47338.

- When hovering over an animated Item with the Hand tool, forcing a page switch using Generate or switching to Design View using the 'p' shortcut would cause the hover controls to remain on screen unintentionally. Now fixed so that hover controls no longer persist.
Fixes bug 45908.
- REPORTER now respects the OA_INSTALL_xx environment variable (taking precedence over OA_INSTALL environment variable, but not oasys*install_dir oa_pref option).
Fixes bugs 39730, 47855.
- Fixed a crash that occurred while launching the HTML manual through the Help menu on Unix systems. Updated code for launching HTML manual to work with a wider range of default browsers on Windows.
Fixes bug 45812.
- The default image name for a new T/HIS Item is now incremented correctly to provide a unique name.
Fixes bug 47780.
- Fixed an issue in which pre-existing D3PLOT and T/HIS items of blank type were not being given a new default image file name when changing type.
Fixes bug 47791.

Version 18.1

- Corrected neck and femur inputs for Humanetics Harmonized HIII 5F v2.02 model dummies so that they use cross sections rather than beams (in a small number of templates). Further investigation into how the Harmonized model varies from the regular version is currently underway (Case 46414).
Fixes bug 46756.
- T-HIS Items with JavaScript type and Image output were not producing an image on Generate. Now fixed to behave in the same manner as old method FAST-TCF capture. Old T-HIS Items with JavaScript type and Image output that had been configured to work correctly by writing the image from the JavaScript may need to be edited.
Fixes bug 46521.
- Right-aligned text was sometimes clipped in PDF output. Now fixed.
Fixes bug 43230.
- Improved REPORTER's handling of filepaths for the Autotable 'File' option. Updated guidance has been added to the manual.
Fixes bug 46292.
- When running REPORTER in batch from SHELL with REPORTER iconised, an odd windowing bug was causing the Combined Output Options to sometimes produce corrupted files. This should no longer be the case.
Fixes bug 45660.



- Updating an image capture for a D3PLOT Item with an image file extension of .jpg, .bmp, or .ppm will no longer overwrite these extensions with .png.
Fixes bug 46113.
- %TEMPLATE_DIR% was not set early enough when a Template was being opened, causing Image Items that were attempting to use this variable to appear as 'missing images'. Now fixed.
Fixes bug 46258.
- The filetype, job, resolution, and cropping properties have been added to the Javascript Item class (for certain Item types).
Fixes enhancement 45772.

Version 18.0

- Support for the playback of MP4 movies and animated GIFs has been added to REPORTER. These can be captured directly from D3PLOT for use with a D3PLOT Item, or be added to a template through an Image or Image File Item. Playback can be controlled by hovering over the Item or using the buttons in the new animation toolbar.
Fixes enhancements 3485, 9337, 13491, 29174, and 36334.
- The "Ansys LS-DYNA Version and Revision" version.js Library Program script has been updated so that it works with newer d3hsp/OTF files that can include (1) An Ansys legal notices header above the LSTC header (2) Ansys LS-DYNA revision names incorporating the newer Git revision hashes instead of the older SVN revision numbers.
Fixes bug 45562.
- The Legacy GUI theme has been deprecated and is no longer accessible from the Preferences dialog. If you wish, you can still select Legacy theme via reporter*guit_theme in your oa_pref file.
Fixes enhancement 45506.
- If you open a template created in REPORTER 16.1 or earlier in REPORTER 18.0 or later, any D3PLOT and T/HIS items will continue to be captured and generated using the old pre-version-17 method (in versions 17.0 and 17.1, they were automatically converted to the new method, but this caused problems for some users' templates).
Fixes bug 45224.
- Along with the rest of the Oasys Suite, REPORTER has transitioned to LM-X licensing for version 18.0, so the FLEXlm licence is no longer supported.
Fixes enhancement 44733.
- The first sixteen colours saved in PRIMER, D3PLOT or T/HIS are now read into REPORTER via the user_colours.xml file and are accessible via the 'Custom colors' panel (select 'More colours...'). Any user colours added in REPORTER via 'Add to Custom Colors' can be saved to user_colours.xml via the new 'Fonts and Colours' tab in the Preferences dialog and will thereafter be accessible in PRIMER, D3PLOT and T/HIS.
Fixes enhancement 44540.



- Font and user colour settings can now be saved directly from REPORTER via the new 'Fonts and Colours' tab in the Preferences dialog. There is also a new 'Startup' tab with preferences for maximising the main window, and also to specify the starting directory for REPORTER (previously these preferences could only be modified via the preferences editor in the other programs).
Fixes enhancement 39537.
- The 'Ansys LS-DYNA' tab in the Preferences dialog has been renamed 'Oasys Items'. All of the settings in the Program Locations dialog have been moved to this tab, and they can now be saved from REPORTER along with the other preferences.
Fixes enhancement 42966.
- You can now use the -pptx command line argument to trigger PowerPoint output. Both -pptx and -ppt arguments have the same behaviour (they output .pptx files).
Similarly, the JavaScript API method Template.Ppt has been deprecated in favour of Template.Pptx (both continue to output .pptx files).
Fixes enhancement 44261.
- REPORTER has been able to write PowerPoint (.pptx) files since version 11. As of version 18, support for the old .ppt VBA output has been removed.
Fixes enhancement 44259.
- All Dialogs accessed via the Menu bar (or created via JavaScript) should now appear on the same display screen as the Main Window. If manually repositioned, these Dialogs should remember their previous position when being reopened. When moving the Main Window to a new display screen, all of these Dialogs should follow to the new screen (excluding an open Logfile or a maximised Dialog).
Fixes bug 14096.
- All MainWindow keyboard shortcuts can now be used while the Logfile has focus.
Fixes bug 43423.
- You can now specify a font mapping table CSV file in a location other than the installation location, to make customised font mapping more convenient.
Fixes enhancement 44127.
- The JavaScript function Template.EditVariables now accepts an optional bool argument to determine whether selected Variables should be displayed alphabetically (true) or in the list order in which they were passed to the function (false).
Fixes bug 44362.
- The page number listed in the page navigation box will now correctly correspond to the current page (usually the last in the Template) after writing a PDF, Pptx, or HTML file.
Fixes bug 45394.
- The page number in the MainWindow title bar will now correctly display the current page (usually the last in the Template) after report generation.
Fixes bug 45632.
- Filename in the MainWindow title bar will now correctly have an asterisk appended to it to indicate the file has been modified when Variables are edited



or updated.

Fixes bug 43422.

- D3PLOT Items will no longer sometimes fail to load the image when conducting a fresh 'old method' Capture.

Fixes bug 45056.

Version 17.1

- Fixed an issue where D3PLOT and T/HIS sessions launched by REPORTER as part of a batch process would sometimes fail to terminate when REPORTER closed, if the batch process included the command line argument -exit.
Fixes bug 44451.
- When using the drag feature to resize multiple Items simultaneously using a handle type that is not present on both Items (e.g. the non-corner handles specific to 'rectangular' Items), using this handle will no longer resize the Item that would not normally have this handle.
Fixes bug 44279.
- If an image file for an Image Item cannot be located when opening a Template, a 'missing image' icon is now printed on the page in its place.
Fixes bug 44278.
- The erroneous 'Cannot crop image' warning will no longer appear in the Logfile when first creating an Image Item (prior to choosing an image file).
Fixes bug 44276.
- If the reporter_font_cache file became corrupted, this could cause REPORTER to crash upon opening. Now fixed.
Fixes bug 44257.
- Report Page should no longer appear to change size (without any change in zoom percentage) after generating a thumbnail (e.g. by saving the Template or opening the Template Properties window).
Fixes bug 44049.
- Warning messages for missing fonts when loading a Template are now displayed only once for each font. The same is true for an incompatible Font + Style combination.
Fixes bug 43639.
- Characters like '<' no longer interfere with the formatting of certain messages in the Logfile.
Fixes bug 43903.
- REPORTER now correctly reads the CURRENT directory oa_pref file from the directory pointed to by the start_in preference when this is used in the OA_ADMIN, OA_INSTALL, or OA_HOME oa_prefs.
Fixes bug 43902.
- A warning message is now printed to the Logfile if any of PRIMER, T/HIS, or D3PLOT can't be located on starting REPORTER.
Fixes bug 43189.
- Edit windows are now mapped to appear above the selected Item in all cases.
Fixes bug 43201.



- Edit D3PLOT Dialog no longer maps to the top-left of screen 1.
Fixes bug 43579.
- All MainWindow keyboard shortcuts can now be used while the Logfile has focus.
Fixes bug 43423.
- It is no longer possible for the first click using the Select tool after saving a Template to select the wrong Item or coordinates on the page.
Fixes bug 43462.
- Item outlines set to none using `lineStyle=.LINE_NONE` in the javascript API are no longer printed when writing to pdf or pptx.
Fixes bug 43975.
- Selection box now updates correctly when moving invisible Items with no outline, fill, or text colour.
Fixes bug 43231.
- Recent Files list is now limited to 50 files and no longer deleted when opening while skipping the Choose Template window (e.g. by opening a Template from File Explorer by double-clicking on the .ort file).
Fixes bug 43609.
- When a D3PLOT item created with the old (v16) capture method was updated using the new (v17.0) method, it remained flagged as using the old method. Now fixed. Also, it was possible to update the parent of an old multi-capture D3PLOT item using the new method, leading to orphaned children. Now, a warning is shown to prompt you to convert the item to the new method first.
Fixes bug 43613.

Version 17.0

- REPORTER can now be linked to both D3PLOT and T/HIS, or the D3PLOT->T/HIS link, by opening one program from another. This allows reports to be created and edited interactively. Windows and graphs can be captured into REPORTER easily and reloaded back from REPORTER, all in the same session. When generating reports, D3PLOT and T/HIS items will be generated in the same session of their respective programs without loading the same model more than once.
Fixes enhancement 40886.
- Custom cell borders in Tables are no longer displayed if the table line colour is set to 'none'. The Cell Borders window now starts with the custom border width set to the current line width setting for the table rather than 'none'. Non-custom border widths no longer revert to the original line width of the table when adding new custom borders.
Fixes bug 43091.
- In the JavaScript API, a new constructor has been added for the Page class, with an options Object argument allowing page name, colour and index to be specified. The original constructor is now deprecated.
Fixes enhancement 41733.



- REPORTER's user interface has been upgraded, with new Light and Dark themes, new icon and cursor designs, and improved toolbars.
Fixes enhancement 37477.
- The cursors for the different Tools have been updated to make it clearer when you need to drag a box, or just click somewhere on the page.
Fixes enhancement 35877.
- A range of standard template layouts is now provided with REPORTER to provide creative inspiration, and to help you quickly create reports for a variety of applications.
Fixes enhancement 13490.
- A recent files list has been added to the library template selection dialog and can be accessed from the File menu.
Fixes enhancement 8820.
- The close button ('X') has been enabled for all dialog windows.
Fixes enhancement 42660.
- It is now possible to deselect individual items using Ctrl + Click or Shift + Click when the user has multiple items selected.
Fixes enhancement 42457.
- A splash screen showing new features is now displayed when REPORTER opens.
Fixes enhancement 42683.
- Formatting control for the DATE variable has been added using %DATE(format)%.
Fixes enhancement 42117.
- It is now possible to select all items on the current page with the shortcut Ctrl+A and to deselect all items in the current template with the shortcut Ctrl+Shift+A or the Esc key.
Fixes enhancement 42659.
- could occasionally write error messages 'QFont::setPixelSize: Pixel size <= 0' to the terminal window on Linux. This has now been fixed.
Fixes bug 41639.
- If REPORTER was launched on a server running a virtual display using Xvfb versions 1.18 or later, REPORTER would abort with the message 'Floating point exception(core dumped)'. Now fixed.
Fixes bug 42402.
- The Logfile now displays more licensing information when REPORTER starts.
Fixes enhancement 42196.
- It is now possible to save preferences directly from REPORTER via the 'Save preferences' button on the preferences dialog (accessed from File -> Preferences). Various new preferences have been added to improve customisation of REPORTER. The Template Generation preferences have been moved to the new Template -> Properties menu.
Fixes enhancement 42116.
- You can now File -> Save As... Template, Report, PDF, PowerPoint and HTML. You can still write PDF, PowerPoint and HTML from File -> Write PDF etc.
Fixes enhancement 42030.
- The Automotive library templates now support a range of dummy models from different suppliers. The default entity IDs/labels are now provided to make setup



easier.

Fixes enhancement 27000.

- New GUI themes (Light and Dark) have been added to give REPORTER a modernised look and feel. The Legacy theme will continue to be supported for now, but support may be removed in future versions.

Fixes enhancement 37479.

- A 'Generate' toolbar has been added to the top of the main window as another way of generating templates, pages and selected items.

Fixes enhancement 17290.

- A 'Page' toolbar has been added to the top of the main window to improve access to page creation, deletion, duplication, and page navigation controls.

Fixes enhancement 42466.

- With 'Snap to grid' enabled, items on the page no longer snap when selected (only when moved). Changed behaviour of snapping such that items snap to grid based on chosen reference corner defined in preferences. When snap size exceeds nudge size, nudge now uses snap size instead to ensure nudging always possible.

Fixes bug 42328.

- Sizes of rows/columns in tables no longer automatically reset unless the 'Reset heights' or 'Reset widths' buttons are explicitly pressed. A new checkbox has been added to the Edit Table Dialog: 'Fix overall table size while adding/deleting/resizing rows and columns'. When unticked, row/column operations are able to adjust overall table size. When ticked, rows/columns scale proportionally after each operation to fit original table size. A similar checkbox has been added to Edit Autotable Dialog, applied only to columns.

Fixes bug 41773.

- Trying to close a session with modified files prompts the user to save changes. REPORTER would close anyway even if the user cancelled the save dialog. Now fixed.

Fixes bug 41935.

- When reading a T/HIS item containing a FAST-TCF script, REPORTER would remove any semicolons (e.g. found in entity names). Semicolons are now preserved.

Fixes bug 41735.

- In the JavaScript API Image class, it is now possible to set an alternative background colour (including 'none') via a new third argument in the Image constructor. Also, previously, setting lineColour to 'none' had no effect, and setting lineWidth equal to zero resulted in a line width of 1. Now fixed so that either setting will result in no line being drawn.

Fixes enhancement 41602.

- Problems encountered when modifying individual Table cell border widths via the JavaScript API, especially when reducing the existing border width, have been fixed.

Fixes bug 42600.



- The page orientation now automatically changes to landscape when you select a PowerPoint page size in File -> Page setup.
Fixes enhancement 41651.
- Image size can now be controlled for 'Blank' PRIMER, D3PLOT and T/HIS items (so that any images created via scripts or command files can have image size control).
Fixes enhancement 41674.
- Templates containing the text "%CURRENT_PAGE%/%TOTAL_PAGES%" would result in an error message when written to PowerPoint. Now fixed.
Fixes bug 41676.
- The Tools have been grouped into categories, and it is now possible to switch on labels for the tool buttons.
Fixes enhancement 41603.
- Improved access to the page master view: a page master view toggle button (shortcut key 'm') has been added to the View toolbar, and corresponding toggles have been added to the View and Page menus. The old Master dock widget has been removed.
Fixes enhancement 41604.
- Newly-created items now remain selected, so that they can more conveniently be moved, resized or deleted. Keyboard shortcuts have been added for the Select tool ('s') and the Hand tool ('h').
Fixes enhancement 40700.
- Images drawn using the JavaScript API Image class are now drawn with antialiasing to improve image quality.
Fixes enhancement 41022.
- The attributes (geometry, style, font, paragraph, alignment) of all selected items can now be controlled via new toolbars in the main window.
Fixes enhancement 7764.
- It is now possible to set the line width and line colour of Autotable items. It is now also possible to set the fill and text colour for all cells/columns in Table/Autotable items via the Style toolbar.
Fixes enhancement 40106.

Version 16.1

- When opening a template was aborted, it could sometimes cause REPORTER to crash. Now fixed.
Fixes bug 41717.
- When a Table or Autotable item was created or resized, it would actually be given 0.99 times the requested width and height. Now fixed.
Fixes bug 40697.
- Page hyperlinks did not work for Table items in HTML output, and they did not work for Table or Autotable items in PDF output. Now fixed.
Fixes bug 39208.



- Page hyperlinks were not given the underlined magenta style for Table items in Presentation view. Now fixed.
Fixes bug 39207.
- It was not possible to get/set the lineColour property for Table items via the JavaScript API. Now fixed.
Fixes bug 40105.
- If items are moved or resized using the mouse, or if items are aligned, distributed or rearranged from the context menu, the changes are now recorded as changes to the template, and a save prompt appears when the template is closed.
Fixes bug 39981.
- If captures were deleted from a D3PLOT item that had already been edited, REPORTER would crash. Now fixed.
Fixes bugs 38195 and 40531.
- In Presentation view, if the location of a Script item was clicked with the Hand tool, the script would run, even if the Script item was not a button script. Now fixed so that only button scripts can be run by clicking on them.
Fixes bug 40016.
- For non-legacy fonts in Tables and Autotables, cell text was aligned incorrectly in PDF output if 'middle' text alignment was selected. Now fixed.
Fixes bug 40065.
- Setting the output of an Autotable Library Program to a variable and clicking OK would cause REPORTER to crash. Fixed by hiding this Library Program feature for Autotables, since it was inapplicable in the first place.
Fixes bug 40602.
- If an item containing a Program or Library Program was generated via the Item.Generate method in a Script item, the Program or Library Program output would not be returned. Now fixed.
Fixes bug 40384.
- In the JavaScript API, some of the properties in the objects returned by Item.GetCellProperties and Item.GetColumnProperties were incorrect for Program and Library Program cells. These have been fixed. A new <output> property has been added for Item.GetCellProperties, and a new <programArgs> property has been added for Item.GetColumnProperties. Also, the <program> and <programArgs> properties were not set correctly by Item.SetCellProperties and Item.SetColumnProperties. Now fixed.
Fixes bugs 40223 and 40528.
- The intrusion plot in the General Ansys LS-DYNA Vehicle template now supports parts of any element type, rather than only shell parts.
Fixes bug 40351.
- If an *INCLUDE or *INCLUDE_PATH card contained valid white space at the beginning of a continuation line, it was incorrectly eliminated when read by certain Library Program scripts. Now fixed.
Fixes bug 40293.
- The *INCLUDE_PATH card was not supported by Library Programs that recursively searched a keyword file and its include files. Support for



*INCLUDE_PATH now added.

Fixes bug 40291.

- Standard templates now support results files with the newer LSTC naming conventions "<name>.d3plot" and "<name>.d3hsp" as well as older "d3plot" and "d3hsp" filenames. In addition, the templates will now search the results directory for any "*.ptf" or "*.d3plot" file if one matching the keyword filename cannot be found.

Fixes bug 40229.

- When generating a PRIMER object the MENU_AUTO_CONFIRM environment variable is no longer set by default. This is because when creating/updating the capture it was not set and the mismatch meant that some macros did not play correctly. If a specific template needs this for some reason it can be set by using the option in the templates preference.

Fixes bug 40591.

Version 16.0

- Previously, REPORTER only supported four fonts (Courier, Helvetica, Times, Symbol). REPORTER now supports many more fonts (TrueType, OpenType, and certain Type1 fonts), giving you greater control over the look of your reports, and allowing you to create templates that match your organisation's branding. Support for Chinese, Japanese, Korean and other non-Latin fonts is much improved.

Fixes enhancements 9008 and 15826, and bug 16376.

- Table and Autotable items can now be exported in Microsoft Excel format, complete with formatting (cell size, text alignment, font style, borders, colours, merged cells).

Fixes enhancement 38249.

- Various new functions have been added to the Item class of the JavaScript API to enable control over Table and Autotable items. It is now possible to: insert/delete/resize rows/columns, merge/unmerge cells, get/set cell properties (e.g. text, alignment, font, colour, border width) and get/set cell conditions.

Fixes enhancements 38250 and 38251.

- PNG images with transparency would appear white in PDF output. Now fixed.

Fixes bug 38792.

- After a PRIMER, D3PLOT or T/HIS capture, the special readonly variables (e.g. REPORTER_TEMP) were being set as writeable, meaning that they would be mistakenly written to the template/report file if it was subsequently saved. Furthermore, after a capture, all variables were being changed to temporary variables. Both now fixed.

Fixes bug 38791.

- When editing a variable of type 'Directory', if "Browse..." was clicked to browse for a directory with a UNC path (e.g. "\\example.com\data\analysis\001"), the value returned would contain forward slashes

("//example.com/data/analysis/001"). Backslashes are now preserved.

Fixes bug 39303.



- When running on Linux a warning "libpng warning: iCCP: known incorrect sRGB profile" would be written to stdout. Now fixed.
Fixes bug 38711.
- The red, green, blue and name properties in the Colour class did not work. When getting the property null would be returned instead of the correct value. Now fixed.
Fixes bug 38772.

Version 15.1

- Various library scripts would terminate with an error if include files in keyword files could not be found. They now print a warning instead.
Fixes bug 38400.
- Table cells with fill colour 'none' were being saved correctly, but would be interpreted as 'black' during copy/paste. Now fixed.
Fixes bug 38334.
- If the border width of Table items was set to 0.75, it was not saved correctly. Also, cell borders were not preserved when a Table item was copied. Both fixed.
Fixes bug 37666.
- Lock symbols for some items remained visible in Presentation view. Now fixed.
Fixes bug 37524.
- The getter for the JavaScript Image class font property did not work correctly. Now fixed.
Fixes bug 38019.
- If a report (.orr file) was opened by double-clicking on it, scripts set to automatically run on opening would run. This is the intended behaviour for templates (.ort files), but not for reports. Now fixed.
Fixes bug 36531.
- After aligning selected items, their positions were not redrawn immediately. Now fixed.
Fixes bug 37803.
- It was possible to nudge and delete locked items. It was also possible to move them via the alignment options in the context menu. These are now disabled for locked items.
Fixes bug 37393.
- With the exception of the Logfile dialog, all dialogs are now modal, to prevent instability and unexpected behaviour.
Fixes bugs 36484, 36660 and 36661.
- A warning message would appear when an empty page was duplicated. Now fixed.
Fixes bug 36304.
- Script buttons were highlighted incorrectly on hover in Presentation view. Now fixed.
Fixes bug 37188.

Version 15.0



- The shortcut (Ctrl+W) for File -> Close didn't work. Now fixed.
Fixes bug 37062.
- When inserting variables into a text field (Ctrl+I), you can now double-click to select the variable (increases speed of use).
Fixes enhancement 36640.
- could crash if the File->Open library template menu was entered before the list of library templates had been read. Now fixed.
Fixes bug 36642.
- On Linux, if REPORTER was started from the command line with a file argument (e.g. reporter14_x64.exe example.ort) then the REPORTER window would be shown too high so the window title bar was not visible. Now fixed.
Fixes bug 36503.
- Depending on the relative aspect ratio between template and display, Zoom -> Fit width and Zoom -> Fit height would not fit correctly (scroll bars would persist).
Now fixed.
Fixes bug 36438.
- On Windows, if REPORTER was started from the command line with both maximise and file arguments (e.g. reporter14_x64.exe -maximise example.ort) then the REPORTER window would not maximise. Now fixed. Also, the active template now resizes in synchrony with the main window.
Fixes bug 36017.
- A special readonly TEMPLATE_DIR variable has been added to REPORTER. The variable value contains the directory path of the current template (for a new template created using File -> New, TEMPLATE_DIR will contain an empty string until it has been saved). The TEMPLATE_DIR variable should be useful when you want to refer to files (e.g. images or scripts) stored relative to the template.
Fixes enhancement 35693.
- REPORTER executables weren't always being digitally signed. Now fixed.
Fixes bug 35004.
- It is now possible to embed Image items into a template (.ort file). By checking the box in the Image item dialog, the image data is embedded directly into the template rather than relying on the link to an external image file.
Fixes enhancement 33088.
- A checkbox has been added in the Script item dialog to skip the generation of button scripts when a template or page is generated. This means that button scripts can now be configured to run only when clicked.
Fixes enhancement 34966.
- The Variables dialog now expands to fit variables with long names, values or descriptions, rather than pushing them to the right of the visible pane in the scrollable area.
Fixes enhancement 34965.
- In PowerPoint files written by REPORTER, Text, Textbox, Table and Autotable items now use 'Exactly' rather than 'Single' line spacing in order to improve visual compatibility with REPORTER.
Fixes bug 35338.



- Read-only properties 'filename' and 'path' have been added to the Template Class in the JavaScript API. These replace the 'name' property, which has been deprecated (and made read-only) from this version onwards.
Fixes enhancement 35186.
- Variable value replacement could previously fail for nested variables at the beginning of a string. Now fixed.
Fixes bug 35152.
- Improvements have been made to the keyboard focus in all REPORTER dialog windows. Tab focus is now consistent and the enter key now has the expected effect.
Fixes bug 35225.
- Editing margins and vertical text justification were not possible in Autotables. They are now possible.
Fixes bug 30631.
- If the Window.Information Class function was used in a Script object, an 'Error' icon was displayed instead of an 'Information' icon. Now fixed.
Fixes bug 34971.
- When in Presentation view, if an object was created by dragging out a rectangle to define its size, the rectangle would continue to change size after the mouse button was released. Now fixed.
Fixes bug 35036.
- Toggling of the 'View page item generation order' button was not synchronised with the checkbox on the View menu. Now fixed.
Fixes bug 35130.
- If the Design view button was clicked when already in Design view, it would toggle to the Presentation view, and vice versa. Toggling now removed.
Fixes bug 35098.

Version 14.1

- If a variable was saved with a floating format precision of 0 the precision was not read correctly when reading a template file. Now fixed.
Fixes bug 34590.
- If a table cell background colour was set to 'none' it was not read correctly when reading a template file. Now fixed.
Fixes bug 34588.
- If a variable contained an expression then the expression would be overwritten by the evaluated value after D3PLOT or T-HIS objects were run. Now fixed.
Fixes bug 34566.
- If a variable contained a format precision then the precision would be overwritten with the default after D3PLOT or T-HIS objects were run. Now fixed.
Fixes bug 34556.
- If REPORTER was started by right clicking on a template file and using 'Open with...' the current directory was set to C:/Windows/System32 on Windows. The current directory is now set to the directory that the template file is read from.
Fixes bug 34555.



- The title library script would not extract the title from an include file if the include file was specified using "+" continuations. Now fixed.
Fixes bug 34511.
- If a program argument contained backslashes then REPORTER would convert them to forward slashes for internal storage but then not convert back to backslashes on Windows when running the program. This could make some external programs fail (e.g. Perl scripts). Now fixed.
Fixes bug 34254.
- T-HIS objects using the JavaScript type did not pass the job file correctly to T-HIS. Now fixed.
Fixes bug 33922.
- If a D3PLOT object captured a plot for one model and was then replayed on a slightly different model then sometimes the wrong elements could be (un)blanked in the plot. Two new options have been added for D3PLOT in File->Program Locations to help in these situations. These options can also be set by preferences.
Fixes bug 33886.
- If the border colour for a table was set to 'none' this was not correct in PowerPoint files produced by REPORTER. Black was incorrectly used. Now fixed.
Fixes bug 33197.
- The logic in REPORTER for reading variables assumed that the name would only contain A-Z, a-z, 0-9 and underscore characters. However the variable dialog and some scripts actually allowed many other characters and this meant that the variable was not processed correctly if other characters were used. The logic has now been changed and variable names can now contain spaces (converted to a single underscore character), A-Z, a-z, 0-9 and the following special characters '{', '}', '[', ']', '/', '\', '@', '.' and '^'. This allows units to be included in variable names. For example the following is now a valid variable name:
ACCELERATION_[mm/s^2]
Fixes bug 31871.

Version 14.0

- When editing an auto table and updating the background colour in conditional formatting the table editing window would be lowered so it was hidden. Now fixed.
Fixes bug 33482.
- When editing conditional formats the background colour could be shown incorrectly. Now fixed.
Fixes bug 33481.
- If you specified that the output from a library program should be saved in a variable it did not work if the variable didn't already exist. Now fixed.
Fixes bug 33329.
- REPORTER could give the wrong initial added mass, initial percent added mass and smallest timestep values for some otf files. Now fixed.
Fixes bug 33272.



- Updating a capture for a D3PLOT object did not work if there was a pre-JavaScript defined. Now fixed.
Fixes bug 33232.
- REPORTER could crash if a temporary variable was deleted by using Delete Temporary Variables in the Variables menu and recreated. Now fixed.
Fixes bug 32988.
- Rows and columns can now be added or deleted from any location in a table.
Enhancements 12788, 13840, 31875.
- Cells in a table can now be merged.
Enhancements 15549, 22387, 31875.
- The borders can now be set for individual cells in a table.
Enhancements 12855, 15549, 22387.
- Conditional formatting can now be copied and pasted from one cell to another.
Enhancements 13842, 15549, 22387.
- The output from a library program and text can now be used together in a table cell.
Enhancement 13866.
- Library programs can now not produce output. This may be useful in some situations. For example the output can set to a variable and the variable used later in a table cell.
- A File.Move method has been added.
Enhancement 31605.
- A File.Copy method has been added.
Enhancement 31603.
- When replacing variables in D3PLOT JavaScripts \ was not escaped to \\. Now fixed.
Fixes bug 32631.

Version 13.1

- The icon shown in the top left of the titlebar when a template was opened was the old (version 12) icon instead of the new (version 13) icon. Now fixed.
Fixes bug 31046.
- The -iconise command line option did not work correctly on linux. Now fixed.
Fixes bug 30982.
- The elapsed time library script did not work for the R8 and R9 versions of Ansys LS-DYNA. Now fixed.
Fixes bug 30565.
- Endash characters () were incorrectly written to pdf files as spaces. Now fixed.
Fixes bug 30654.

Version 13.0

- The aspect ratio or size of images in D3PLOT, PRIMER and T/HIS objects can now be controlled.
Enhancement 29004.



- Images in ImageFile, D3PLOT, PRIMER and T/HIS objects can now be justified. Enhancement 28875.
- An optional index argument has been added to the Page.Duplicate() method. Enhancement 28334.
- The name argument in the Item constructor was ignored. It is now used correctly. Fixes bug 28332.
- Variables can now be marked as temporary variables. Temporary variables can be removed from a template with a new 'Delete temporary variables' command in the Variables menu. Enhancement 27253.
- The format and precision properties were missing from the Variable class. They have now been added. Fixes bug 22881.
- An ImportItem method has been added to the Page class. Enhancement 28221.
- The numbering of 'generated' items on a page missed out tables. Tables have been added as they can contain scripts that need to be generated. Enhancement 27384.

Version 12.1

- When combining reports if one of the reports to combine did not exist hyperlinks could link to the wrong pages. This has been fixed. Fixes bug 27640.
- Values for variables with expressions were not written to the reporter_variables file correctly when generating the report. This has been fixed. Fixes bug 27256.
- REPORTER would delete files in the temporary directory if the directory was set with the oasys*temp_dir preference. Fixes bug 26416.
- Ampersand characters (&) in table objects created corrupt pptx files. This has been fixed. Fixes bug 26906.

Version 12.0

- Circles and ellipses were not rendered correctly in pdf files. Now fixed. Fixes bug 25848.
- REPORTER could crash if a library image was inserted very near the top or right hand edge of a page. This has been fixed. Fixes bug 24988.
- FAST-TCF objects did not use the job filename when generating. FAST-TCF would look in the directory for the job. If there were multiple jobs in the same directory it could choose the wrong file. This has been fixed. Fixes bug 24979.



- Extra commands added to a D3PLOT capture which were longer than 80 characters did not work. This has been fixed.
Fixes bug 24933.
- Objects can now be locked on the page so they cannot accidentally be moved.
Enhancement 23503.
- REPORTER will now prompt the user to replace variables in the macro after doing a capture in PRIMER. For each matched text string you can choose whether to replace it with a variable or you can do "Yes to All" or "No to All".
Enhancement 21309.
- A new Batch() method has been added to JavaScript so scripts can test if REPORTER is running in batch mode.
Enhancement 23990.
- A Duplicate method has been added to the Page class.
Enhancement 17602.
- Static methods GetAll and GetFromName have been added to the Variable class.
Enhancement 22772.
- Report hyperlinks can now have the form '#page title' to link to another page in the report.
Enhancement 22974.
- A DeletePage() method has been added to the Template class in JavaScript.
Enhancement 22974.
- A new EditVariables method has been added to the Template class so that a variables editing panel can be called from JavaScript.
Enhancement 22387.
- A System() method has been added to JavaScript.
Enhancement 15772.
- Script objects can now be shown as a button in presentation mode. Clicking the button runs the script.
Enhancement 22387.
- A single script object in a template can now be set to run automatically when the template is opened.
Enhancement 22387.
- A new Window class has been added to JavaScript to enable standard dialogs to be used.
Enhancement 22387.
- T/HIS objects can now be defined with a JavaScript instead of a FAST-TCF script.
Enhancement 22387.
- New Page and Item classes have been added to JavaScript.
Enhancement 22387.
- Library templates can now be opened directly from the File menu.
Enhancement 22387.
- A File.Delete() method has been added.
Enhancement 22387.

Version 11.2



- Less than signs (<) in text and textbox objects created corrupt pptx files. This has been fixed.
Fixes bug 24613.
- If the Variable constructor was used to redefine an existing variable in a script REPORTER would give an error if you tried to get any of the variable properties later in the script. This has been fixed.
Fixes bug 23586.

Version 11.1

- If a D3PLOT object with multiple captures was updated again in D3PLOT to delete or replace captures REPORTER could produce errors when generating or change the order of the captured images. This has been fixed.
Fixes bug 22227.
- If a D3PLOT object was made that had more than 20 captures and the template saved to file , REPORTER would not be able to read the file again. This has been fixed.
Fixes bug 22226.
- D3PLOT objects using a command file (instead of capturing) did not work in version 11. This has been fixed.
Fixes bug 22147.
- When saving old style T/HIS objects (i.e. using a command file instead of a FAST-TCF script) the command file was not saved. This has been fixed.
Fixes bug 22117.
- Opening the HTML manual did not work on Linux. This has been fixed.
Fixes bug 21989.

Version 11.0

- When writing PowerPoint files REPORTER now correctly writes animated gifs.
Fixes enhancement 17601.
- REPORTER could crash if you created a table that used a library program for a cell and you saved the output of the program to a variable. This has been fixed.
Fixes bug 21346.
- The library program which reported the Ansys LS-DYNA version and revision from the otf file did not work correctly for new (R7) Ansys LS-DYNA output because there is now a new 'SVN Version' line in the otf file. Additionally the version and revision were expected to be to be a single 'word'. This has been fixed.
Fixes bug 21243.
- Outlines were not written for Oasys Ltd. or File Image type objects to PowerPoints. Now added.
Fixes bug 21242
- REPORTER would hang when reading a template file if one of the page titles in the file contained an ampersand (&). This was because the ampersand was not



escaped properly when writing the template. This has been fixed.

Fixes bug 21235

- You can now specify an outline border for file image objects.
Fixes enhancement 18206
- REPORTER can now use D3PLOT to generate multiple images in one session. The second and subsequent images are automatically created as image file objects linked to the d3plot object.
Fixes enhancements 7777 and 13034
- A JavaScript can now be run for D3PLOT and PRIMER objects.
Fixes enhancement 15550
- When capturing an image from D3PLOT, REPORTER now automatically shows the images.
Fixes enhancements 7779 and 10668.
- A new PRIMER object has been added.
Fixes enhancements 8095 and 16530
- REPORTER can now write PowerPoint pptx files directly.
Fixes enhancement 11858
- REPORTER can now combine multiple reports into a single pptx/pdf/html.
Fixes enhancements 7712, 8956, 9020 and 10742
- REPORTER could think that a script had changed when cancelling from the editor if the script was created on windows but edited on unix.
Fixes bug 7769
- When writing a pdf file jpeg images are now written as jpegs rather than pngs as they can be much smaller.
Fixes enhancement 17920
- Added the ability to see the item generation order.
Fixes enhancement 18489

Version 10.2

- REPORTER did not automatically change Ansys LS-DYNA filenames from h3hsp to %DEFAULT_JOB%.otf (and visa-versa) when importing a library page. This has been fixed.
Fixes bug 19200
- REPORTER could crash when writing a pdf file that had overflow pages in an auto-table if there was an error when the report was generated. This has been fixed.
Fixes bug 19197
- The "cropping" button was the default focus in the D3PLOT object edit menu (i.e. was applied when hitting enter) rather than the "OK" button. This has been fixed.
Fixes bug 19113
- REPORTER was not able to create and import image files which were not JPEG when generating a D3PLOT captured object. This has been fixed.
Fixes bug 18403



- REPORTER could crash if the user added a page to the reporter_library/pages area which contained certain REPORTER items. This has been fixed.
Fixes bug 18432

Version 10.1

- If the page layout is changed from landscape to portrait or visa versa any items that are off the page are automatically moved to stay on the page
Fixes bug 14307
- If multiple conditional formatting conditions were set for a table, autotable, textbox or file object background, then REPORTER would display the last condition matched rather than the first one. This has been corrected.
Fixes bug 17794

Version 10.0

- Added the -loghtml command line options to allow the log file to be saved as html instead of plain text.
- Added a Templates tab to preferences to allow the user to change whether existing files should be overwritten when generating images for multiple pages in T/HIS. This is saved as a property of each template
- Added the -iconise and -oasys_batch command line options
- Checkbox for turning on/off error checking during generation when an error was found was not working correctly.
Fixes bug 15143
- Added the ability to set the format of a variable on the variable edit panel.
Closes enhancement 8819.
- Fixed problem with rounding errors on spinbox input values on edit panels.
Fixes bug 15548.
- When resizing/moving a table object, the relative width/height of the columns/rows is now maintained.
Closes enhancement 15546.
- Added a new library script for reading variables from a CSV file.
Closes enhancement 15476.
- The "P" key can now be used to swap between design view and presentation view.
Closes enhancement 9333.
- "Fit page" is now the default zoom level when opening a file.
Closes enhancement 13863.
- Added the ability to use the control key plus the mouse scroll wheel to zoom in and out of the page.
Closes enhancement 15516.
- Added the ability to distribute selected items evenly horizontally or vertically either to the page or within the currently selected items.
Closes enhancement 15509.



- Added the ability to align items to the top/bottom/left/right of the the page.
Closes enhancement 9300.
- You can now specify an outline border for Oasys Ltd. image objects.
Closes enhancement 15503.
- The escape key can now be used to deselect any selected objects. It is still used to quit out of fullscreen mode.
Closes enhancement 15530.
- The total number of pages in the document is now displayed at the top of the window.
Closes enhancement 15513.
- Added preferences to allow the user to specify the format of the default DATE and TIME variables.
Closes enhancement 15529.
- Modified the default variable DATE so that it just shows the date rather than the date and time. A new default variable TIME has been added
Closes enhancement 15453.
- The maximum number of pixels you can crop off an image edge has been increased from 1000 to 10000.
Closes enhancement 15451.
- Textboxes were not copied when duplicating a page. This has been fixed.
Fixes bug 15441.
- Added the ability to write the output of a library program to a variable.
Closes enhancement 9031.
- Added the ability to align multiple objects together. Option are left, centre, right, top, middle or bottom.
Closes enhancement 9300.
- Added the ability to select multiple objects on a page. Multiple objects can be dragged, cut/copied/pasted, saved/imported, generated, resized etc.
Closes enhancements 8980, 9106, 9300.
- Added the ability to format a variable. For example if a number, how many decimal places.
Closes enhancement 13867.
- The text on the status bar could get overwritten during generation of items. Now fixed.
Fixes bug 14230.
- Setting the background colour of various object types via conditional formatting has been added.
Closes enhancement 9026.
- It is now possible to set the background colour of cells in tables.
Closes enhancement 15319.
- A note object has been added for adding notes to the design view of a report.
Closes enhancement 13825 .

Version 9.4.2



- " Hyperlinks for HTML files are now converted to relative links.
Fixes bug 16138.
- If you inserted a normal program into a template by selecting the program tool and dragging an area would think that the object was a library program, not a 'normal' program.
Fixes bug 15133.

Version 9.4

- could crash when accessing variables after using the JavaScript method Template.GetVariableValue() with a variable name that did not exist in the template.
Fixes bug 14347.
- If a job file was selected before doing a capture for a T/HIS object REPORTER would not try to substitute DEFAULT_DIR (and other variables) in the filename.
Now fixed.
Fixes bug 14329.
- If you modified an items outline, fill or text colour or modified its line thickness or style this did not flag the template as requiring a save. This has now been fixed.
Additionally templates which require saving are now marked with a * in the window title.
Fixes bug 13960.
- Exiting from REPORTER using File->close and using the top right window close button now gives the same error message and options to save any modified templates. Previously the messages were different and this caused confusion to some users.
Fixes bug 13430.
- D3PLOT objects with multiple filenames would not work if one (or more) of the filenames contained spaces. This was due to a bug in D3PLOT. Now fixed.
Fixes bug 12409.
- When writing PowerPoint output blank table cells were given the default font size by PowerPoint. As this is very large it caused the table row to be larger.
Fixes bug 13874.
- User defined script directories can now be defined by using the library_directory preference. This allows users to add their own library scripts if REPORTER is installed in a read only location.
Closes enhancement 13503.
- If a library program is added it is now possible to set the font, size, style and justification in the menu. Additionally if you edit an existing library program this menu is now used instead of the 'normal' program menu.
- When generating a report more feedback is now given in the status bar so you know what REPORTER is doing (e.g. running a D3PLOT object in background).
Closes enhancement 13888.



- Report generation can now be stopped at any point by a new 'Stop' button in the status bar.
Closes enhancements 10708 and 11271.
- D3PLOT and T/HIS can now be run from REPORTER without any windows being mapped by either giving the -batch command line option to REPORTER or by setting the batch mode checkbox in File->Program locations. Additionally REPORTER can be minimised during report generation so you can use other programs.
Closes enhancement 10709.
- HTML output has been improved for tables. Previously cell heights could be too high on Internet Explorer and additionally text that was too big for a cell was not cropped.
Fixes bug 13846.
- Once a 'Capture' has been done for D3PLOT or FAST-TCF objects the 'Capture' button is changed to say 'Update capture' as it was not clear that pressing the button again would allow you to change the existing capture rather than starting again from scratch.
Closes enhancement 13757.
- PowerPoint output could sometimes only be done once for each session.
Now fixed.
Fixes bug 13873.
- Page ranges set by the user in the printer dialog were ignored and the whole report was printed. Now fixed.
Fixes bug 13887.
- The Hyperlink dock box was not mapped correctly when a hyperlink was clicked. A similar problem occurred with the 'master page' dock box.
Fixes bug 13827.
- Clicking on a hyperlink that referred to a non-existent report could crash .
Fixes bug 13836.
- PDF output for table cells was not cropped if it was too large for the cell.
Fixes bug 13883.
- If you edited an existing FAST-TCF object that used variables somewhere in the script and you pressed capture to change the script REPORTER prompted you to try to replace text with variables in the new script but no replacements were done. Now been fixed.
Fixes bug 13833.
- Image cropping has been added for Image, ImageFile, D3PLOT and Fast-tcf objects.
Closes enhancement 12854.
- Text wrapping, border style, border colour and background colour have been added to the textfile object.
Closes enhancement 8631.
- A new text colour button has been added to the Style toolbox to change the colour of text (previously the outline colour button changed the colour of text). This was necessary as the new textbox objects have fill colour, border colour and text colour.



- A new textbox object has been added to .
Closes enhancements 9107, 7800 and 3881.

Version 9.3.1

- Visual basic output did not work on windows for text file items that had more than one line of text. Now fixed.
Fixes bug 13165.
- Images for advanced objects in HTML output were scaled incorrectly. Now fixed.
Fixes bug 13159.
- now shows files with extension .pptx as well as extension .ppt when writing PowerPoint files.
- Writing text objects to a PowerPoint file did not work correctly with PowerPoint 2007 (the text was written with a single letter on each line). Additionally:
 - File objects had a black background if a visual basic macro from was read into PowerPoint 2007.
 - Justification of text objects was not correct if a visual basic macro from was read into PowerPoint 2007.
 - Tables had the wrong border and background colours in PowerPoint 2007.
 - The colour of some lines could be incorrect in PowerPoint 2007.Now fixed.
Fixes bugs 13022 and 13138.
- Output from writing text objects to a Powerpoint file and to a visual basic macro could be inconsistent. The textboxes produced when writing a PowerPoint file directly were not resized to fit the text, and textboxes produced from a visual basic macro would have different margins to those produced when writing a PowerPoint file directly. This is now fixed.
- would not play a d3plot command file with 'button click' data correctly. The button click data would be stripped from the command file and the commands treated as dialogue commands. Now fixed.
Fixes bug 13027.
- In an automatically generated table column text entries containing variables would not generate correctly (the variable would be replaced by a blank string) if the variable name was in lower case. Now fixed.
Fixes bug 12995.
- On some platforms when generating a report, a warning message from T/HIS and D3PLOT could be passed to REPORTER in two or more chunks (it should be passed to reporter as a single string). REPORTER would mistakenly think that the second and subsequent chunks were error messages and try to alert the user that an error occurred. This has now been fixed.
Fixes bug 12738.
- If a library object failed to generate properly (e.g. if the otf filename was incorrect) then the next time that generated the report you could get 'Cannot get File data in File destructor' errors. This has been fixed.
Fixes bug 12629.



- When writing tables to powerpoint directly or writing a visual basic macro, the colour and width of table borders was ignored. Now fixed.
Fixes bug 12733.
- The -maximise command line option and maximise oa_pref option did not work correctly on some screens. This has now been fixed.
Fixes bug 12941.
- The hostname library script would fail if the hostname of the machine contained a hyphen (-).
Fixes bug 12413.
- When drawing a polygon with the image.Polygon() function you could not define the line colour as 'none' (it always gave a black outline). This has now been fixed.
Fixes bug 9585.
- If you edited a normal table after generating program data in any of the cells the program output was lost during the edit. This has now been fixed.
Fixes bug 12348.
- If you saved output to html (or vba, pdf) and the file existed you were asked twice if you wanted to overwrite it.
Fixes bug 12428.
- Variable expressions were not correctly evaluated when used in text. Instead of the variable value being evaluated the entire string was evaluated which could sometimes mean that the expression could not be evaluated correctly. This has now been fixed.
Fixes bug 12347.
- Powerpoint output was incorrect for several object types:
 - Bold, italic and underlined text was shown as normal text.
 - Arrowheads were not drawn on arrows.
 - Rectangles and ellipses without fill were still drawn with fill.
 - Dashed and dotted lines were drawn as solid lines.
 - Autotable cells could have the wrong font style and justification.This has now been fixed.
Fixes bug 12433.

Version 9.3 (October 2008)

- When doing conditional formatting the default font for each condition is now the same as the existing font before you asked for conditions (so for example you have to change only the colour). Previously the default font was always 10pt Courier. Closes enhancement 11906.
- If you double click on a variable in the Edit variable menu it now edits the variable. Closes enhancement 11904.
- In design mode, programs that use library scripts now have %REPORTER_HOME%/reporter_library/scripts removed from the beginning of the text that is shown on the object so it is easier to see what the program is.
Fixes bug 7701.
- A library script has been added to read a reporter variables file. Closes enhancement 11902.



- Printing did not work for autotable objects. This has now been fixed. Fixes bug 11848
- The library directory for has been renamed to 'reporter_library'. Existing scripts which use 'library' will be modified when reads the file.
- In the menu that is mapped when the user right clicks on an object, Edit and Delete were next to each other. Occasionally people pressed Delete by mistake. A space has been added to the menu either side of the Delete button to make it harder to delete the object by accident. Fixes bug 11332.
- When the dyna filetype preference was changed in it did not change the filetypes for any existing objects in the template.
Additionally, when opening a template, if the preference was set to the Oasys Ltd. filetypes, would silently change any 'd3hsp', 'd3thdt' and 'd3plot' definitions to '%DEFAULT_JOB.otf', '%DEFAULT_JOB.thf' and '%DEFAULT_JOB.ptf' and there was no way to undo this change.
Now if you change the preference interactively looks to see if any filenames need updating. If they do then it asks you if you want to change them.
Similarly, if you read a template checks and asks you if you want to change them. However, this is not done if the batch option has been set.
Fixes bugs 9782, 10613 and 11438.
- Library scripts which retrieve data from the end otf file have been made significantly quicker. Fixes bug 9479
- It is now possible to have D3PLOT and FAST-TCF objects that do not return images to REPORTER. Fixes bugs 9028 and 9108.
- A new 'Expression' variable type has been added that allows user to do simple maths with variables. e.g. (%THREE%+%ONE)*%THREE%/TWO%. In fact it will evaluate the expression as a JavaScript expression so Math.sqrt(), Math.sin() etc are also available. Fixes bugs 9010, 9017 and 9111.
- After reading in a template, now shows the first page, not the last page. Fixes bug 9006.
- All dialog boxes in now have a maximise button to make them easier to resize if they need to be made bigger (e.g. if editing a FAST-TCF object). Fixes bug 8793
- Normal table objects have now been added to . Closes enhancements 7233, 7703 and 7704.
- Postscript output has been removed from for version 9.3. Use pdf output instead.
- Added File.Mkdir() method to create a directory.
- Added File.APPEND constant to enable appending to files.
- Library scripts in tables did not work if there was a space in the installation directory of . Additionally any variables that were used as arguments would not have been expanded correctly (they would get the value from the current template instead of the value from the reporter_variables file). Fixes bug 9451.
- Added pdf_image_downsample, pdf_image_downsample_resolution and pdf_image_downsample_threshold preferences to allow image downsampling when writing pdf files.
- Added use_file_vars preference to enable filenames returned from D3PLOT and T/HIS to be replaced with directory/file variables automatically if they match



Version 9.2.3 [Build 36] (21/11/2006)

- would create a corrupt pdf file if a page contained a zero size image. This has now been fixed. Fixes bug 9315
- If special characters like > and < were used in a condition name could not read the template file. Now fixed. Fixes bug 9220.
- Fixed problem with text in pdf files not printing properly on some printers. Fixes bugs 9134 and 9212.
- The output from a table can now be written to a CSV file during generation. Closes enhancement 9133.
- now gives the user the ability to stop report generation if an error occurs. Closes enhancement 9126.
- Some objects with a line colour and/or fill colour of none were not being rendered properly (black was used instead). This has now been fixed. Fixes bug 9081.
- would get the start in directory wrong for T/HIS and D3PLOT if there was a single jobfile that contained spaces. This could cause T/HIS to crash. This has now been fixed. Fixes bug 9038.
- Library scripts could not be used as table items (an error occurred when they were run). This has now been fixed. Fixes bug 9024.
- It is now possible to generate a single page of a report. Closes enhancement 9011.
- Powerpoint could be left open after writing a powerpoint file. This would happen if the -exit command line argument was given after the -ppt argument. This has now been fixed. Additionally Powerpoint will now not be closed if there is an existing presentation open in Powerpoint. Fixes bug 8998.
- The extension orp was not automatically appended when exporting a page (if the filename has no extension). It is now added if required. Additionally ps is added for postscript, pdf for Acrobat, htm for HTML (html on unix), bas for Visual basic macros, and ppt for Powerpoint. Fixes bug 8988.
- If a library page (e.g. checking page) was inserted into a template and the Oasys Ltd. filenaming scheme was used (file.thf instead of d3thdt etc.) the objects would not generate properly as they referred to d3thdt, d3hsp etc. This has now been fixed. Fixes bug 8954.
- is now more intelligent when pasting multiple copies of an item. Additionally the pasted item is now selected. Fixes bug 8861.
- On Solaris 10 it was possible what errors when generating T/HIS objects did not get logged properly. This meant that sometimes the user was not notified that an error occurred. This has now been fixed. Fixes bug 8487.

Version 9.2.1 [Build 35] (26/7/2006)

- Switching between templates on HP unix machines caused to get stuck in a loop refreshing the screen until the mouse was moved out of the template. This has now been fixed



- Multiple spaces in arguments to external programs were simplified to a single space. This was incorrect and has now been fixed. Fixes bug 8857.
- Recapturing from T/HIS could fail if there were multiple models. This has now been fixed. Fixes bug 8842.
- When capturing from D3PLOT and T/HIS on Windows sometimes DEFAULT_DIR was not replaced in the filename. This occurred if slashes (/ or \) did not match between the variable and filename. Now fixed. Additionally, now if DEFAULT_DIR does not match REPORTER will try to use other Directory variables to match. Fixes bugs 8314 and 8758.
- Compounded variables (i.e. variables that contained variables) did not expand correctly. Now fixed. Fixes bug 8669.
- Arguments to an external program which used variables that contained spaces would not be passed to the program correctly. Now fixed. Fixes bug 8666.
- Brackets (,),[,],{,} and slashes \,/ in arguments to an external program could cause to hang. Now fixed. Fixes bug 8665.
- Fixed bug that caused spurious pages to be created when a page was duplicated. Fixes bug 8716.

Version 9.2 [Build 34] (24/5/2006)

- Fixed bug that caused the current page number on a master page to be incorrect when printing. Fixes bug 8628.
- Fixed bug that caused corrupt pdf output if there were images on the master page. Fixes bug 8629.
- Fixed problems with missing output from running external programs
- Adding a new page while an object was selected would erroneously leave the selection handles drawn on the new page. Now fixed. Fixes bug 8530.
- Fix problem in javascript File class that caused errors in File destructor.
- Output from T/HIS and D3PLOT was not written to the logfile for Solaris 10. Now fixed.
- Errors and warnings from D3PLOT and T/HIS are now fed to REPORTER via stderr so they now correctly come through as errors and REPORTER is aware of them.
- The log window is now raised when it is mapped as previously it could get lost behind the main window.
- Hyperlink rectangle produced in pdf files for text objects with hyperlinks is now correct if the text object used variables. Fixes bug 8405.
- Objects that are not visible are now not selectable. Fixes bug 8404.

Version 9.2 Beta 4 [Build 33] (4/4/2006)

- Fix problem with centre justified text in HTML (it was not positioned correctly as the style was incorrect).
- Hyperlinks from objects other than tables containing variables now work correctly.
- Hyperlinks now open a report in presentation mode (this was broken in an earlier release).



- Output from program items with hyperlinks is now correctly written when writing a report.
- Cursor used when hovering over hyperlinks is now correct on Windows
- Replacing subsequent variables in table cell contents and hyperlinks would fail if the first variable in the text did not exist. This is now fixed.
- Fixed JavaScript compiling problems on SGI that caused crashes.

Version 9.2 Beta 3 [Build 30] (20/2/2006)

- Add unicode support for writing pdf files. Partially fixes enhancement 7799 (no ps support yet). Unicode characters can be used in text objects and table headers.
- Add ability for capturing from T/HIS to read a cvs file. As no jobfile is returned N/A is shown. Fixes bug 8151.
- D3PLOT objects can now use multiple models and/or windows. When using capture new models can be opened. When you return to all of the models and windows are remembered. Fixes enhancement 7237.
- Object coordinates can now be specified by using 2 corners or by using a corner and width/height. This can be set by a preference. Fixes enhancement 7811.
- You can now search and replace strings in objects. Fixes enhancement 7820.
- Text items can now be vertically justified as well as horizontally. This should help line up output from text items and program items. Fixes enhancement 7812.
- D3PLOT and T/HIS are now passed the '-maximise' command line argument to ensure that they are full screen.
- The FAST-TCF and T/HIS tools are now combined into one tool as people found having two tools confusing. Fixes enhancement 7818.
- now has different cursors depending on which tool is used. Fixes enhancement 7817.
- Variables can now be given a type to help manage/distinguish them.
- File and directory variables can now be browsed for. Fixes dynatrack cases 7688 and 6857.
- You can now find and loop over all the warnings and errors written to the logfile.
- If an error occurs when generating now shows a dialog box to tell the user and gives the ability to show the error. Fixes bug 7771
- Added this changelog to the help menu in .
- Added ability to create, drag etc in presentation mode. Fixes dynatrack bug 7766.
- Added 'hand' tool to presentation view which allows you to follow hyperlinks etc.
- Added a 'write Report' option in the file menu to make saving as a report easier (previously you had to do SaveAs and change filetype). Fixes enhancement 7778.
- now remembers the directory from the last file you selected and uses that as the start directory for the next file selection. Fixes enhancement 7714.
- Added powerpoint size as a page size. Fixes enhancement 7709.
- Existing bitmaps are now deleted before generating advanced objects. This is to guard against picking up old data by mistake. Fixes enhancement 7772.
- Variables now have their own menu. Fixes enhancement 7819.
- Variables are now saved by default when generating. Fixes enhancement 7687.



- Now gives an error if a save did not work because a file or directory is write protected.
- Automatically replace job names with DEFAULT_DIR and DEFAULT_JOB when capturing. Can be turned off with a preference. Fixes enhancement 7657.
- A default size is now given to an object if the user doesn't drag when creating an object. This size can be set with an oa_pref option. Fixes enhancement 7696.
- CURRENT_PAGE variable now works correctly on a master page when writing pdf, vba and ppt. Fixes bug 7892
- Colour buttons now set correctly for WindowsXP style in Colour Dialog. Fixes bug 7647
- Added conditional formatting for textfile objects. Fixes bug 7606
- Shift and Ctrl keys now constrain lines, arrows, rectangles and ellipses when dragging. Fixes bug 7733
- version.js script bug fixed. Fixes bug 7695.
- The initial text properties are now set correctly for text file items. Fixes bugs 7647 and 7605.
- LSTC/Oasys Ltd. filenaming can now be set as a preference. Fixes bug 7692 and enhancement 7630
- Images are now embedded when saving as a report. Fixes bug 7660.
- Online manual now linked to from Help menu
- now prompts you to save a template before closing if any changes have been made
- Variables can now be used in condition values
- When the mouse enters the report you now get the keyboard focus
- -log= argument now works.
- bug fix 7774. now traps template files that don't exist on the command line and skips remaining arguments but does not skip -exit or -log= so it doesn't hang
- Change name to .
- Unicode support added for text object strings (no postscript or pdf support)
- The -generate command line option now always generates the report. Previously it only generated in design mode. This meant that if you opened a report you could not generate it (as it is opened in presentation mode)
- '\' characters in filenames etc are now converted to '/' characters on unix machines.
- Change logic for multiple models in T-HIS to that Presenter passes the directory of the first model as the -start_in argument.
- Added us-ncap.js library script to plot US-NCAP graph
- Added fontAngle and fontJustify properties to javascript Image class to give more control of text rendering

Version 9.2 [Build 21] (14/11/2005)

- Added maximise preference for Presenter
- Presenter now reads the start_in and vba_directory preferences
- Presenter now picks up variables from T-HIS correctly when there are multiple analyses



- In the variables dialog the whole row is now highlighted when you select a variable instead of just the first column.
- When adding a library program Presenter now checks to see if any compulsory arguments are missing.
- When a new file is created a new page is now automatically started.
- Added more error checking to data_file_from_variables.js script (bug fix 7635)
- Added LogPrint, LogWarning and LogError methods to global javascript object
- Added File->close option (was previously under Window->close but obviously people expect it to be under the file menu! (bug fix 7637)
- If you change drawing mode when in presentation mode you are now automatically taken back to design mode (bug fix 7636)
- If you right click on an object when in any drawing mode you will change to select mode, select the item and map the popup menu (bug fix 7634).
- Added ability to reorder pages (enhancement 7571)
- Variable values and descriptions are now escaped properly when saving so special characters can be used (&,<,> etc)
- When capturing a FAST-TCF script, if the job file is not empty it is read into T/HIS (previously it was only done if there was a script as well)
- When you edit a text item a crosshair is now shown at the point the text is justified to
- If you paste an item on the same page it is now offset from the original by the nudge distance so it is obvious to the user that a new item has been pasted. If you paste into a different page or template it will be placed in the original position
- Right clicking on the page when you do not have a selected item now gives you the option to paste an item at that location (if you have copied or cut an item previously)
- Table items can now be written directly to PowerPoint
- Table items can now be written to vba
- Add -ppt command line option to write powerpoint files
- Subroutines in visual basic macros written by Presenter are now automatically split if necessary to keep them below the 64k limit for VBA (previously there was one Subroutine per page)
- If a table with overflow pages is read from a report, the overflow pages are now correctly displayed. Previously you would have to regenerate or edit the table.
- Added support for multiple models for T-HIS and Fasttcf scripts
- PRESENTER_DEFAULT_DIR is now set to the user home directory instead of the temp directory when starting. Setting it to the temp directory caused lots of problems (e.g. the next time you start Presenter that directory probably won't exist!)
- New library script added to create D3PLOT data files from csv file
- Bug fix. When dragging new items they were sometimes not drawn properly (Presenter thought that they were off the screen when they were not)
- Dragging a new item is now double buffered so you don't get flicker
- New library script added to create D3PLOT data files from variables file



- Presenter now tries to preserve variables in FAST-TCF scripts when the user uses the capture feature to update the script.
- If user does not type extension when saving file '.opt' is now automatically added to the filename.
- Added Ctrl+V shortcut for Paste item
- Bug fix. When you save a template using SaveAs the template name is now updated after the save to the new name
- Bug fix. When a report was generated the template could lose the keyboard focus so PgUp, PgDown etc did not work properly.
- Bug fix. Presenter crashed when double clicking on page if in line, arrow mode etc
- Add ability to load and save fasttcf scripts from editing panel
- Added next page and previous page to Page menu
- Added window menu with window list, tile, cascade etc
- When a file is opened or a new file is created it now appears maximised instead of a window
- Fixed bugs in page setup dialog (not initialised properly for some page sizes and orientations)
- Fixed bugs when writing advanced item images to vba and ppt. They were not sized correctly
- Fixed bug that caused Presenter to crash on windows when paging up/down and selecting items
- Changed comments.js script so that newlines are added correctly.
- Revise and fix javascript destrructor and garbage collection problems
- Add javascript method Close to template object
- Add ability to include debug information in logfile from D3PLOT and T/HIS
- Bug fix 7218. Printing advanced items positioned them incorrectly
- Add Star method to Image class
- Add ability to change linecap and linejoin styles in Image class
- Added Polygon, Polyline and Fill methods to Image class
- T/HIS is now called with display=X instead of display=batch so that FAST-TCF works correctly
- Bug fix 6841. When changing the visibility of items by using the checkboxes in the view menu the template did not update immediately. It now does.
- Bug fix 6948. Presenter could crash when inserting an image if it was close to the edge of the page. Now fixed.
- Bug fix 6950. If a keyword file/otf file did not have a title the scripts to return the title returned an empty string. Some people thought that the script was not working. If there is no title the scripts now return 'no title'
- Bug fix 6953. Scripts containing errors caused Presenter to crash on linux.
- Bug fix 6954. Insert Variable dialog box was being mapped with the 'Save variables' buttons from the File->variables dialog box. Now removed. Additionally, I have changed the dialog caption to something more sensible.
- Bug fix 6957. When duplicating a page image items did not get duplicated.
- Builds now automatically add the date compiled (which is shown in the help about dialog box)



- Bug fix. total_mass.js did not work. Now fixed.
- Add overflow pages for automatically generated tables which have too many rows to fit on one page (in the area allocated to the table) Currently works for drawing, printing, postscript, html and pdf
- Add direct PowerPoint output for windows version
- Write JavaScript API documentation
- Bug fix 6655. Scripts could run very slowly on Windows machines but very quickly on HP workstations. This was because the script i/o was written using the C++ standard library. It has been rewritten in C and is now significantly faster.
- The variable PRESENTER_DEFAULT_DIR is now initially set to the same value as PRESENTER_TEMP when creating a new template. This is so that if you capture from D3PLOT or T/HIS the images you create are put in a sensible location until you change PRESENTER_DEFAULT_DIR to whatever value you want.
- FlexLM licensing has now been added to Presenter. The dll Imgr9a.dll must be given out and put in the same directory as the executable for windows.
- You can now change the script used in T/HIS when capturing. If you press 'Capture...' for a second time. T/HIS will replay the FAST-TCF script and you can then update as required and resave.
- Enhancement 6508. You can now edit the command file used in D3PLOT when capturing. Additionally you can now change the settings that D3PLOT creates. If you press 'Capture...' again D3PLOT will now replay the settings and properties file and you can then update as required and resave.
- Bug fix 6688. Right clicking on an object when in presentation mode and anything other than select mode caused Presenter to crash. This has been fixed.
- Bug fix 6654. When capturing from D3PLOT, if the image file was longer than 80 characters, Presenter would not correctly write the command file. This has now been fixed.
- Bug fix 6653. If a library javascript file was missing Presenter could crash. Presenter will now write an error to the logfile window
- Comment lines in oa_pref files are now correctly skipped
- Added this ChangeLog
- Initial internal releases of .

Version 9.0

Build	Date	Description
0 - 0.9		Initial internal releases of REPORTER
1.0	November 2003	First release



2.3. Text Conventions Used in this Manual

2.3.1. Typefaces

Typefaces

Four different typefaces are used in this manual:

Manual Text	This typeface is used for text in this manual
Computer type	This one is used to show what the computer types.
Operator type	This is used to show what you must type
Button text	This is used for screen menu buttons and headings



3. Themes for the Graphical User Interface

Themes for the Graphical User Interface

3 themes are available for Oasys LS-DYNA Environment software. Users can select a **Light**, a **Dark** or a **Classic** theme. The latter uses the colours of the old user interface (used prior to version 17 of the software).

The themes offer different colour and contrast options for comfort and accessibility.

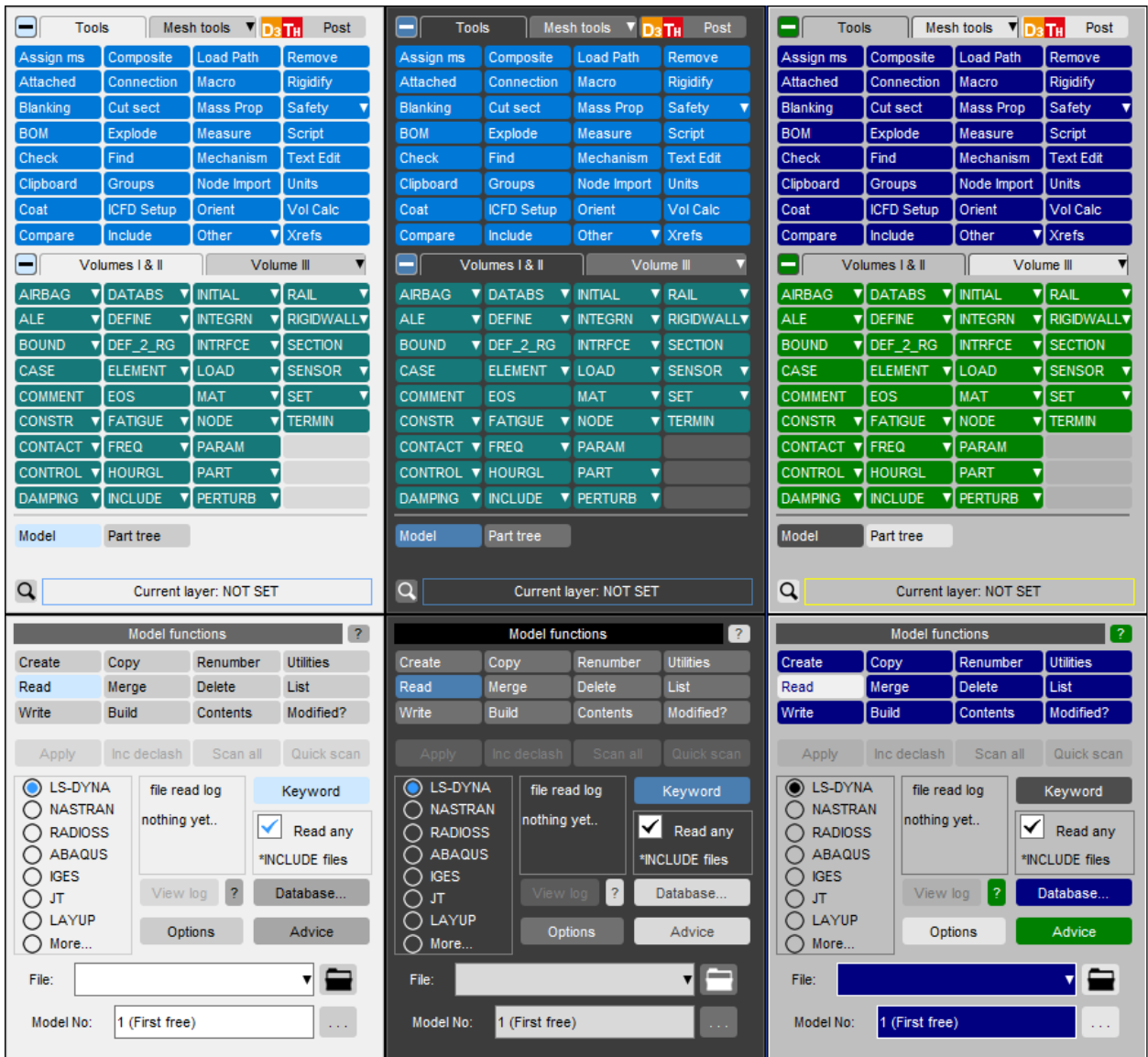



3.1. Setting the Theme

Setting the theme

The default software theme in Oasys 23.0 is **Light**. This can be changed from the Oasys SHELL by choosing from the **Themes** pop-up. This automatically saves the selected theme as your preference for all programs.

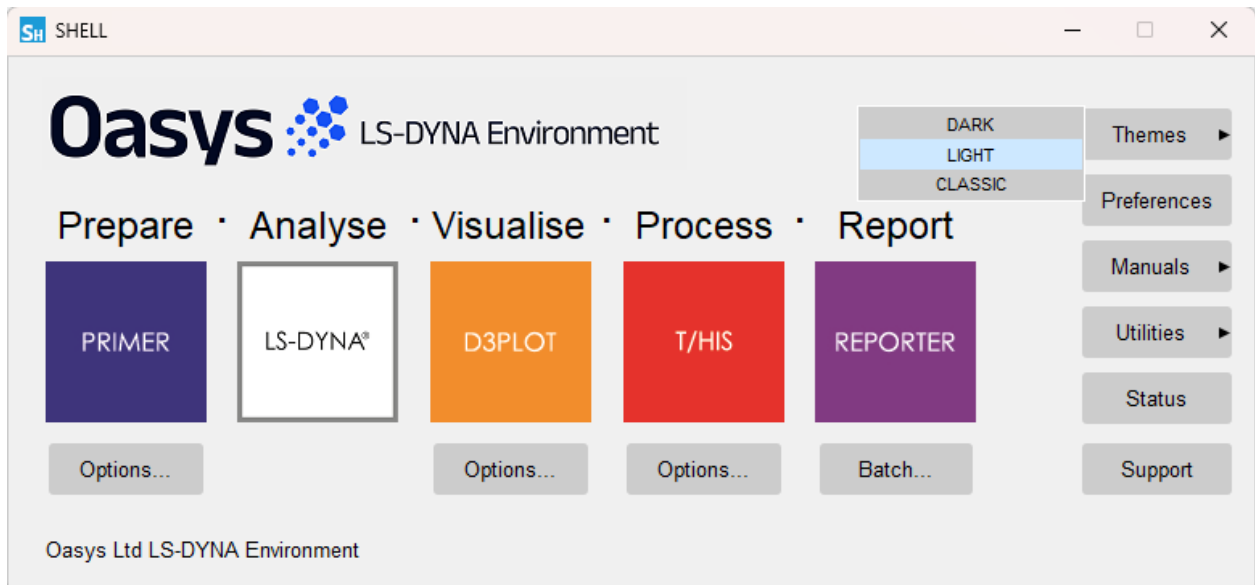

The theme can also be set for individual programs from the **Display** menu in PRIMER, D3PLOT and T/HIS or the **Preferences** menu (**File->Preferences...**) in REPORTER. This choice is not automatically retained after exiting the program, so you must select a theme, then select **Save pref** to ensure a theme is used for all future sessions.

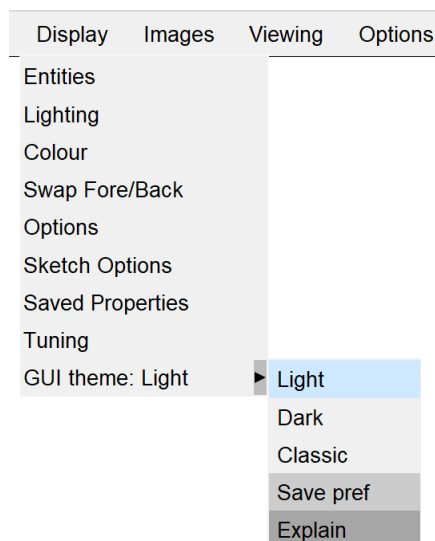

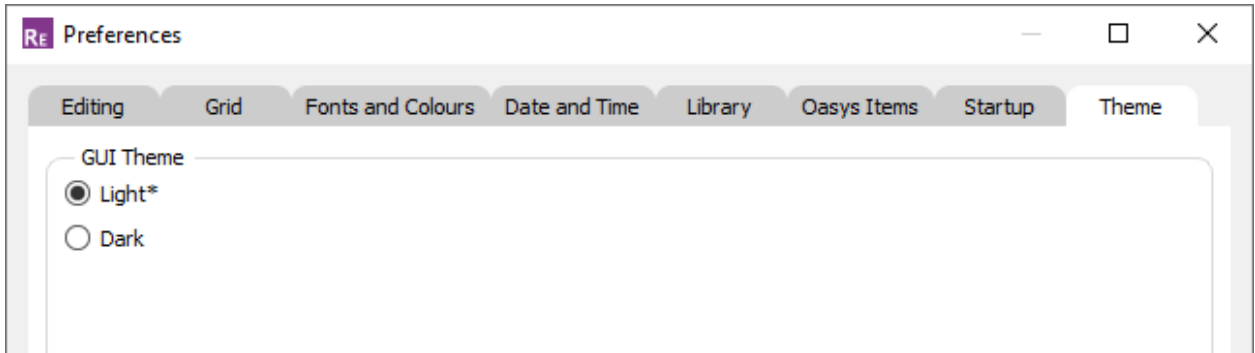



4. Setting Up and Running REPORTER

4.1. Setting Up REPORTER

4.1.1. Prerequisites

Prerequisites

Oasys LS-DYNA Environment software

You should already have the standard Oasys LS-DYNA Environment software T/HIS (including FAST-TCF) and D3PLOT installed, and have licenses for the software. The folders that the Oasys LS-DYNA Environment software is installed in must not have any special characters in folder names (e.g. &, !, ~, ', "). Just use letters, numbers spaces and underscores for folder names.

e.g. the following example is invalid: C:\Program Files\Ove Arup & Partners\arup 23

this is valid: C:\Program Files\Ove Arup\arup 23

4.1.2. REPORTER Installation

REPORTER installation

For more details, refer to the installation guide (copies available at <https://www.oasys-software.com/dyna/downloads/oasys-suite>).

Licensing

REPORTER uses LMX licensing. For REPORTER to run you must have a valid license for REPORTER or alternatively a license for D3PLOT , PRIMER or T/HIS .

Troubleshooting

If REPORTER does not run then check the following.

1. Do you have a license to run REPORTER ? If not contact Oasys Ltd Support.
2. Do you have D3PLOT and T/HIS installed?
3. Do you have licenses for D3PLOT and T/HIS ?



4.2. Running REPORTER

Running REPORTER

REPORTER is run by selecting the **REPORTER** button menu in Oasys SHELL.

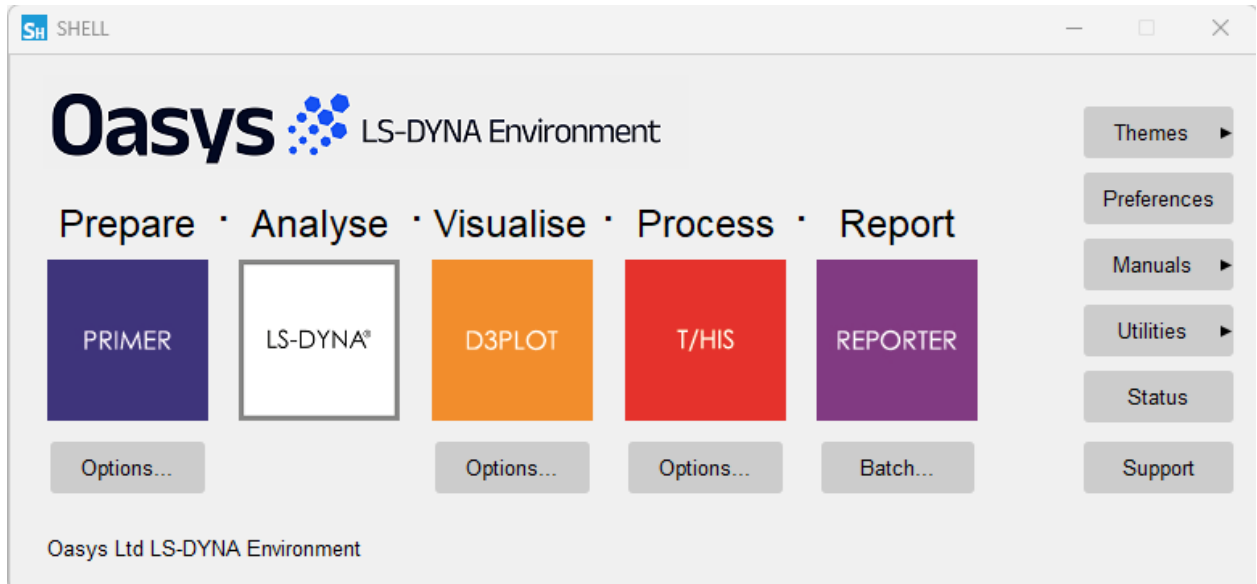

Alternatively, you can right click on the button to give starting options for REPORTER .



4.3. A One Minute Introduction to REPORTER

A one-minute introduction to REPORTER

REPORTER is designed to help you automate your Ansys LS-DYNA analysis post-processing. The idea is that you create a template which contains the instructions or 'recipe' for how to process an analysis. When you run REPORTER on some analysis results, it takes this template, applies it to the analysis and creates a report which you can save as PowerPoint, PDF or HTML.

For example, you may wish to run a set of standard checks on an analysis after it has run to check that the analysis terminated normally, that there was not too much added mass, that the energy balance is acceptable, etc. You could create a checking template in REPORTER and then this would be applied to each analysis you want to check.

A summary of the steps required to make a template is:

1. Start REPORTER . See [Running REPORTER](#) for more details.
2. Create a template. See [Creating a new template](#) for more details.
3. Create pages (and/or a master page) if required. See [Inserting and editing pages](#) for more details.
4. Add objects on to pages. These can be simple things such as lines, text etc or advanced things like D3PLOT or T/HIS objects. See [Inserting and editing simple objects](#) and [Advanced objects](#) for more details.
5. Use variables to make the template generic. See [Working with Variables](#) for more details.
6. Save the template. See [Saving a template](#) for more details.

Once you have created a template you can apply it to analyses as many times as you want.

1. Start REPORTER . See [Running REPORTER](#) for more details.
2. Open the template. See [Opening a template](#) for more details.
3. Set the current analysis variable(s). See [User defined variables](#) for more details.
4. Generate the report. See [Generating reports](#) for more details.
5. Create output such as report, PowerPoint, HTML, PDF etc. See [Outputting a generated report](#) for more details.



5. Menu Layout

5.1. Basic Menu Layout

Basic menu layout

A typical REPORTER session will look like this:

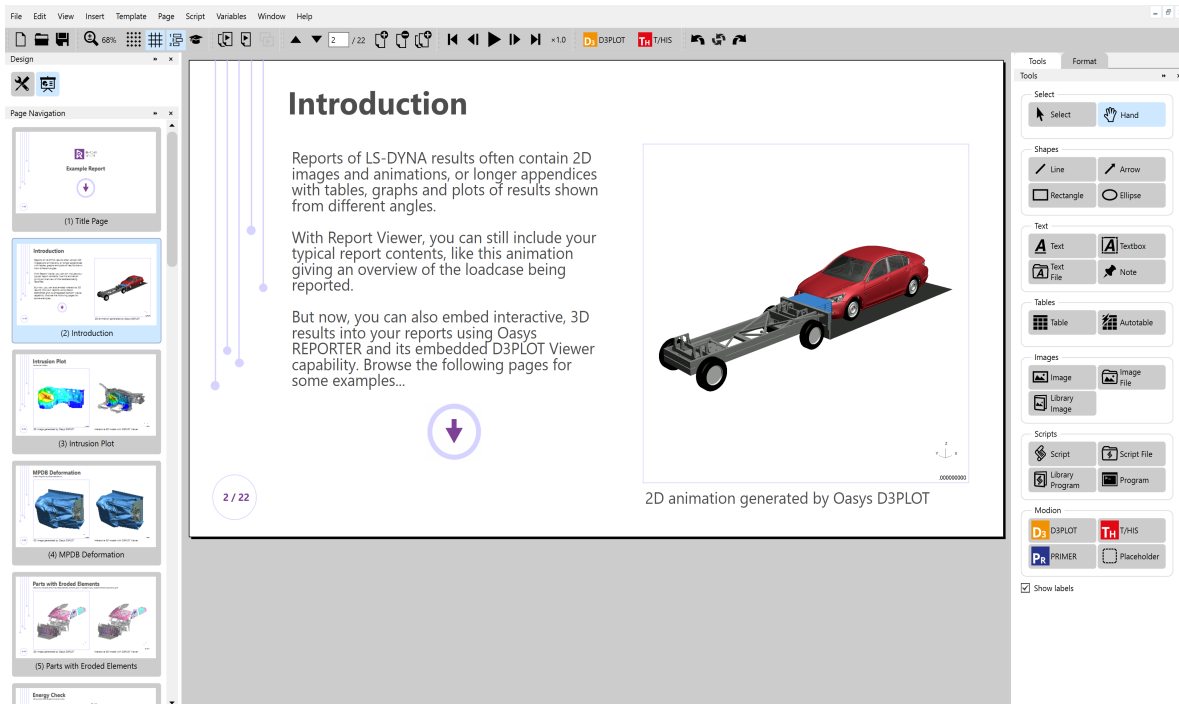

Within this main window there are a number of sections

- "Menu Bar" Access to the main pull down menus.
- " [File](#) " toolbar for opening, saving, and creating report template.
- " [View](#) " toolbar for changing the view.
- " [Generate](#) " toolbar for generating your report, page, and items.
- " [Page](#) " toolbar to navigate your report.
- " [Animation](#) " toolbar to control playback for animated items.
- " [Oasys link](#) " toolbar to open linked instances of D3PLOT and T/HIS.
- " [Undo](#) " toolbar to host undo and redo functionality.
- " [Design](#) " toolbar to switch between the presentation and design view.
- " [Page Navigation](#) " toolbar to navigate your report easily.
- " [Tools](#) " toolbar for creating and editing shapes and advanced objects.
- " [Format](#) " toolbar to modify items in the report.
- "Main Report Area" Main working area.

File toolbar



The file toolbar gives a quick way to create a new template, open a template or save a template. See [Opening and Closing Templates and Reports](#) for more details.

View toolbar



The view toolbar gives a quick way of zooming in and out of the template using the magnifying glass button. This is the same as using the [Zoom](#) submenu from the [View](#) menu. There are also 4 further buttons which control (from left to right respectively):

- the [grid visibility](#),
- the [snap](#) option,
- the visibility of the [item generation order](#), and,
- the [page master](#) view.

Generate toolbar



The generate toolbar includes 3 buttons which can be used to [generate](#) the entire report, the current page, or the currently selected items. These options are also available in various other places (e.g. the [File](#) and Template menus, the [Page](#) menu, and the [right-click context menu](#) for certain items).

Page toolbar

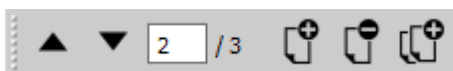

The page toolbar provides arrow buttons to navigate up or down a page as well as an input box to jump to a specific page. The 3 remaining buttons enable addition, deletion, and duplication of pages. See [Inserting and Editing Pages](#) for more details.

Animation toolbar



Starting with 18.0, the D3PLOT, Image, and Image File Item types now support animation. The animation toolbar provides buttons for controlling the playback of all animated Items on the current page. From left to right, these buttons have the following functions:



- Restart - pause all animations and go back to the first frame.
- Step back - pause all animations and go back one frame.
- Play/Pause - play or pause all animations.
- Step forward - pause all animations and go forward one frame.
- End - pause all animations and skip to the final frame.
- Speed - adjust the speed at which animations are played (as a factor of their base frames per second).

Oasys link toolbar

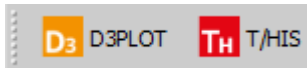

The Oasys link toolbar provides buttons for opening linked instances of D3PLOT and T/HIS.

Undo toolbar



The undo toolbar hosts the undo and redo functionality in REPORTER. It also gives you access to the undo history menu. See [Undo](#) for more details on undo in REPORTER.

Design toolbar



The two buttons on the design toolbar buttons allow you to swap between the "design" view (wrench and screwdriver icon) and the "presentation" view (easel icon) . See [Generating Reports](#) for more details. By default the Design toolbar is docked on the left hand side. However you can drag it and make it a floating menu if you wish. The "p" keyboard shortcut can be used to toggle between "design" view and "presentation" view.

Page Navigation toolbar



The Page Navigation bar allows you to easily navigate your report. This toolbar gives you the following functionality:

- Scroll through page thumbnails; click on a page thumbnail to move to that page
- Drag-and-drop to re-order pages
- Right click to:
 - Insert page after
 - Insert page before
 - Delete page
 - Duplicate page
 - Edit page properties

As you modify your report, the page thumbnails will update in real-time.

See [Inserting and Editing Pages](#) for more details.

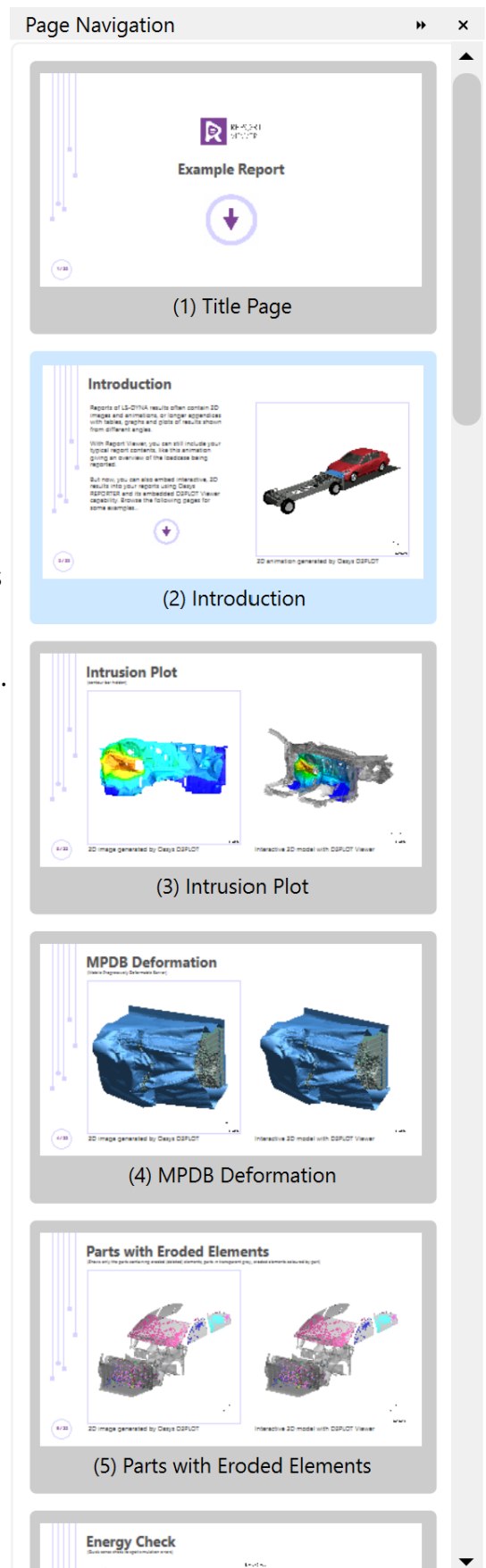

Tools toolbar

The Tools toolbar on the left contains the various objects which you can place on the page. These may be [simple objects](#) such as [lines](#), [rectangles](#), [text](#) etc or more complicated objects such as a [D3PLOT object](#) or a [library program](#). All of these items are also accessible from the [Insert](#) menu.

The level of detail shown alongside the Tool icons can be controlled using the "Show labels" checkbox. Here we have "Show labels" ticked so that each icon is given accompanying text. This is the same text that is shown when letting the mouse hover over the button for a couple of seconds.

By default the Tools toolbar is docked on the left hand side. However you can drag it and make it a floating menu if you wish.

See [Inserting and Editing Simple Objects](#) and [Advanced Objects](#) for more details.

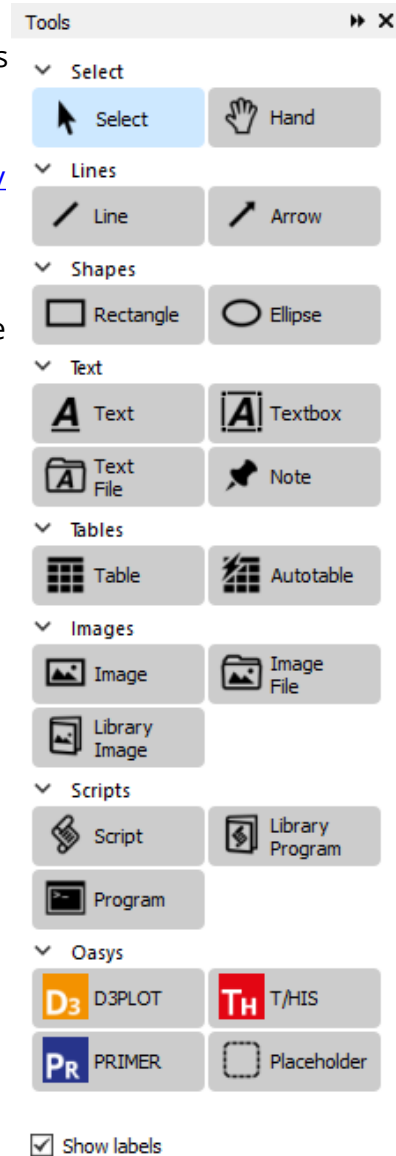

Format toolbar

On the right of the page behind the Tools toolbar, the Format toolbar is used for quick editing of items. Changes made here affect all currently selected items. All toolbars undockable and can be rearranged at will (or removed entirely by pressing the X button). Removed toolbars can be replaced using [View ... Toolbars](#). The Format toolbar can be accessed either by creating an item, which will bring the Format toolbar to the front (see [Editing](#) for more details), or by pressing on the "Format" tab. The Format toolbar contains five sections:

- [Geometry](#)
- [Style](#)
- [Font](#)
- [Paragraph](#)
- [Arrange/Align items](#)

Geometry

The Geometry section provides a means of controlling the precise size and location of Items on a page. The options displayed here correspond to the chosen 'Object coordinates' in the Editing tab of the Preferences window (see below). When 'Use one corner, width, and height' is selected, the X and Y values in the Geometry toolbar give coordinates for the chosen Reference Corner of the selected item while W and H give its width and height. When 'Use 2 opposite corners' is selected, X, Y, W, H are replaced by X1, Y1, X2, Y2 respectively.

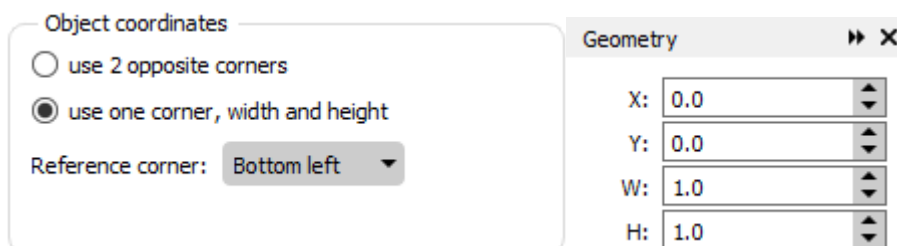

Style

The Style section can be used to change the [line style](#), [line width](#), [line colour](#), [fill colour](#) and [text colour](#) for shapes. See [Setting line style, thickness, colour and fill colour](#) for more details.

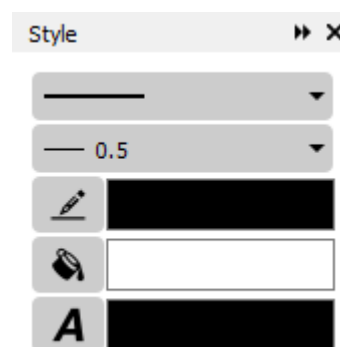

Font

The Font section can be used to change the font, font size, and style (bold, italic, underline). This can be used, for example, to quickly change the font settings for all entries in a table.

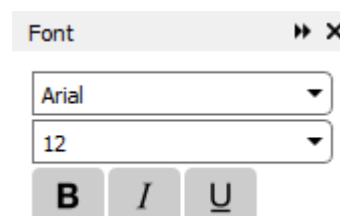

Paragraph

The Paragraph section can be used to change the horizontal and vertical alignment of text within items. This affects Items in the Text and Tables item groups.

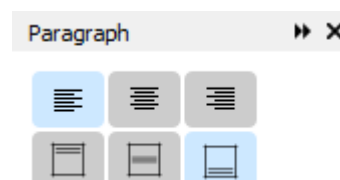



Arrange/Align items

The Arrange/Align section can be used to change the positioning of Items relative to one another. The top row of buttons alter how Items are stacked on top of one another (e.g. for positioning Text or a Note on top of another Item). The drop down button on the second row has options 'Align to Selection' or 'Align to Page' which determines how the buttons on the bottom two rows are implemented. The bottom two rows feature the alignment buttons. With 'Align to Selection' in use, pressing the 'Align left' button will align all selected items to the leftmost item. With 'Align to Page' selected, pressing the 'Align left' button will align all selected items to the left of the page. Functionality of the other buttons is provided in tooltips, accessed by hovering over the button for a few seconds with the cursor.

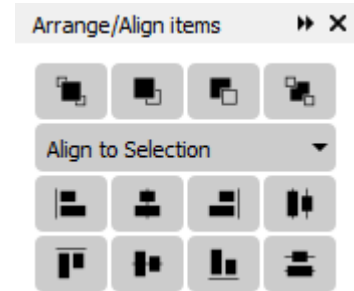

5.2. Mouse and Keyboard Usage for the Screen Menu Interface

Mouse and keyboard usage for the screen-menu interface

Most screen-menu operations are driven with the left mouse button only, but there are exceptions:

- Text in the dialogue area and text boxes requires keyboard entry;
- Text strings saved in the cursor "cut" buffer may be "pasted" into dialogue areas and text boxes using the middle mouse button.

The primitive "widgets" in the menu interface are used as follows:

5.2.1. Buttons

Buttons





Screen buttons are depressed and highlighted by clicking on them. Some buttons remain set when they have been selected and will continue to appear depressed and highlighted.

Buttons may be set by REPORTER itself, for example the cursor arrow button on the right, to indicate that this option is in force. They may also be greyed out, to indicate that the option is not currently available (e.g. the hand button on the right).

"Popup" window invocation : Some buttons when selected will invoke a "popup" window, from which a selection can be made. The popup is invoked by clicking on the triangle.

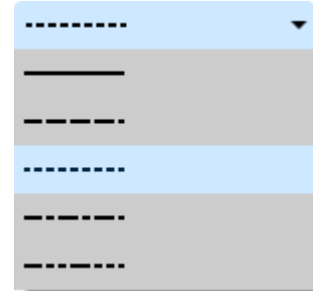

5.2.2. Text Boxes

Text boxes

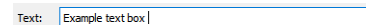

To enter text in a text box: first make it "live" by clicking on it then type in text into the screen that appears. You can use the left and right arrow keys for line editing within a box, text entry takes place after the current cursor position. The cursor is shown as a flashing vertical bar.

Right clicking the mouse button in a text box maps the menu on the right which allows you to copy and paste text from the clipboard and (where applicable) insert a variable ([see Working with Variables](#)).

Undo	Ctrl+Z
Redo	Ctrl+Y
Cut	Ctrl+X
Copy	Ctrl+C
Paste	Ctrl+V
Delete	
Select All	Ctrl+A
Insert variable	Ctrl+I



5.3. Using The "File Filter" Boxes

Using the "file filter" boxes.

Wherever REPORTER requires you to enter a filename you will be presented with a text box into which to type it. However, to the right of this text box you will also see a **Choose** button, which may be used to invoke a basic file filter box. The appearance of this is operating system dependent.

5.3.1. Basic Unix File Filter Box

Basic UNIX file filter box

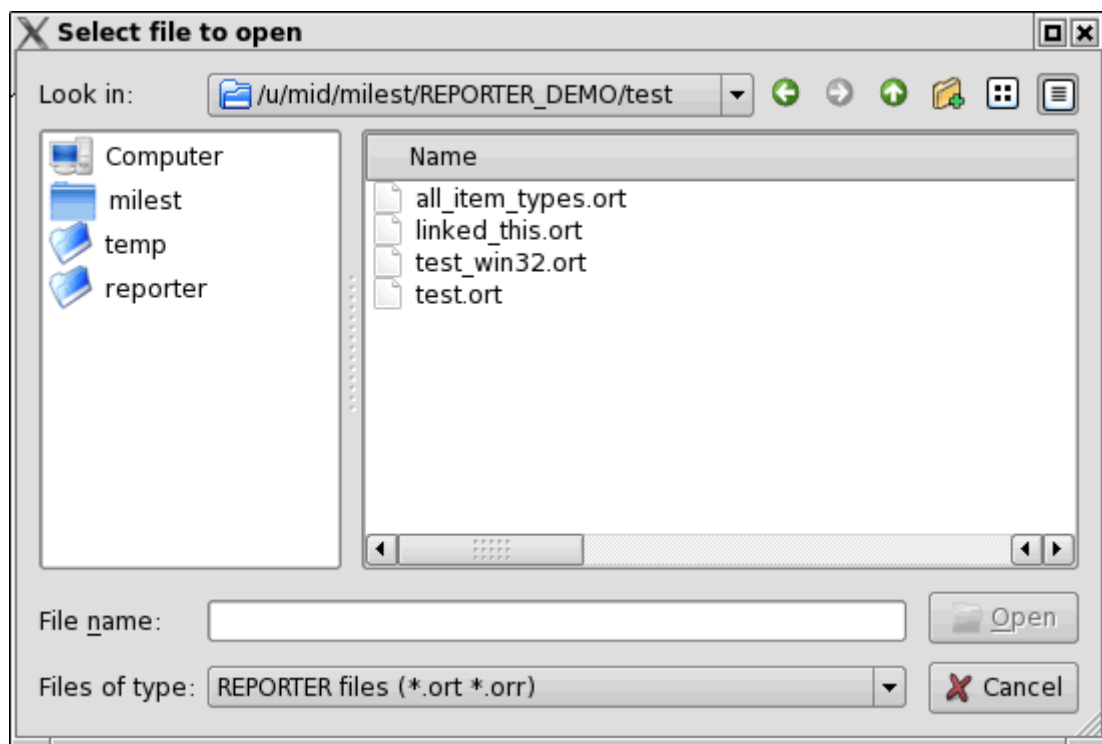

The files can be filtered according to file types by using the **File type** popup, in this case the pathname is `/u/mid/milest/REPORTER_DEMO/test/` and the pattern is `*.ort` (REPORTER template) and `*.orr` (REPORTER report).

The main window show a list of the directories within the present one and a list of files that match the filter selection. Files or directories can be selected by double-clicking on them.

To go back up the directory tree you need to select the  button, or you can click on the **Look in** popup to select any of the parent directories.

The **File name** box shows the current selection.

The **Open** button closes the file filter box and opens the selected file



The **Cancel** button closes the file filter box without opening any files

As an alternative to selecting a file and pressing **Open** you can double-click (quickly) on the file to make your selection.

The left hand area of the menu shows commonly used directories. In this case **temp** , **reporter** . You can add directories to the list by dragging them from the main area and dropping them. Clicking on one of these directories updates the main area to that directory.

5.3.2. Basic Windows File Filter Box

Basic "Windows" file filter box

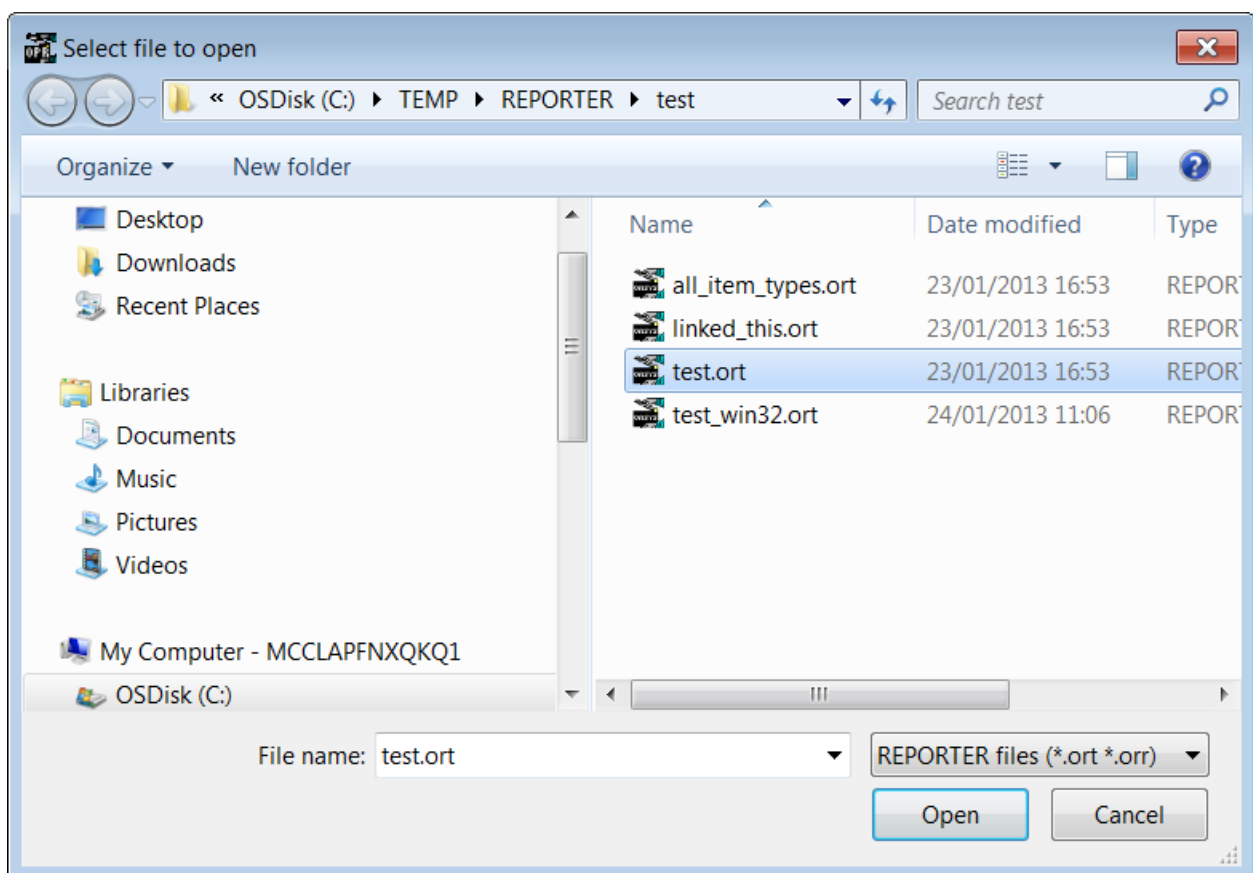

Double-click on the directory required, then on the filename you wish to open.

To open files that do not have the default extension you will need to select **All files (*.*)** from the **Files of type** pull-down menu.



5.4. Log File

Log file

REPORTER creates a log file as it runs. This log file shows how REPORTER is trying to run programs, how it is creating images, and so on.

If any errors or warnings are encountered, they will be written to the log file. This helps you solve any problems.

The log file is accessible from **Logfile** in the **Help** menu. A typical log file window is shown below.

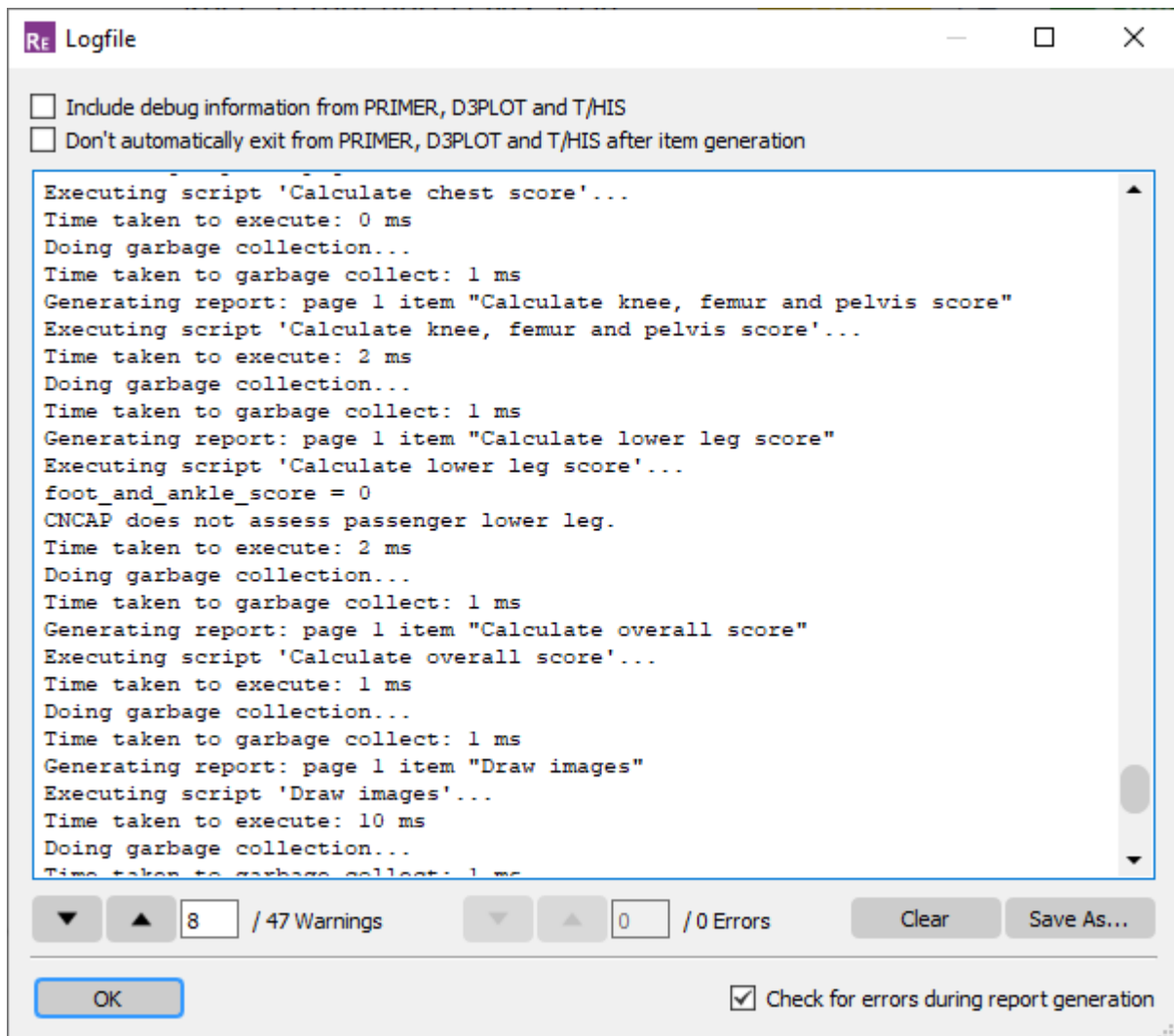
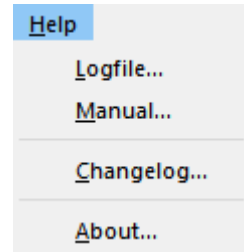

Clicking **Clear** will empty the log file contents. You can save the contents of the log to a text file using the **Save As...** option.



When generating a report (or page, or selected items), if **Check for errors during report generation** is checked (the default), then if an error is encountered, the Logfile window will appear. This gives you the opportunity to examine the error before choosing whether to **Stop** , **Continue** , or **Continue to end** :

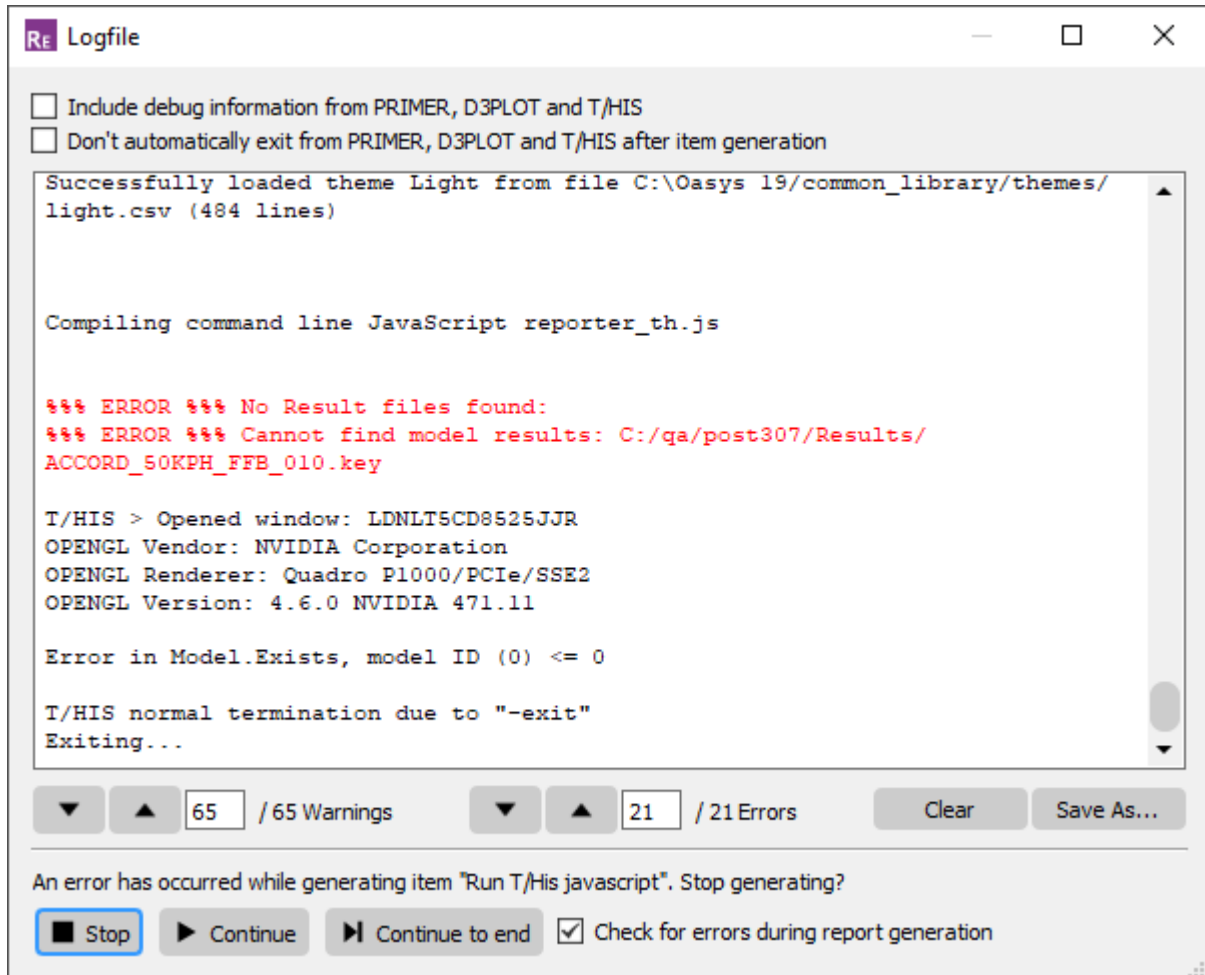

You can navigate up and down through the errors and warnings in the log file using the controls provided. If you choose **Stop** , the report generation will stop, allowing you to fix the error immediately. If you choose **Continue** , generation will continue, and the Logfile window will reappear if another error occurs. If you choose **Continue to end** , generation will continue to the end without showing you the Logfile window again if further errors occur.

You can prevent the Logfile window from appearing when an error occurs by unchecking **Check for errors during report generation** . In this case, you will still be asked at the end of generation if you would like to inspect the log file:

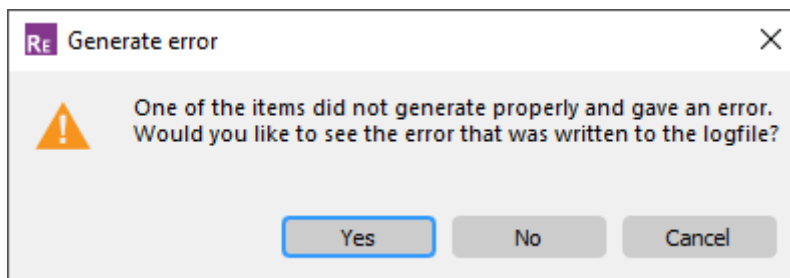

The Logfile window also has some additional options for PRIMER , D3PLOT , and T/HIS items. Selecting **Include debug information from PRIMER , D3PLOT , and T/HIS** will request extra debug messages to be sent back to the REPORTER log file during generation. This can help debug problematic items. Selecting **Don't automatically exit from PRIMER , D3PLOT , and T/HIS after item generation** will mean that those programs will remain open, allowing you to check what has happened before manually exiting them to proceed with the rest of the report generation.

The following options are automatically saved to your REPORTER preferences upon selection:

- **Include debug information from PRIMER , D3PLOT , and T/HIS**
- **Don't automatically exit from PRIMER , D3PLOT , and T/HIS after item generation**
- **Check for errors during report generation**



5.5. View Controls

View Controls

What is and isn't displayed on the screen and how far zoomed in or out the page is can be controlled from the **View** menu

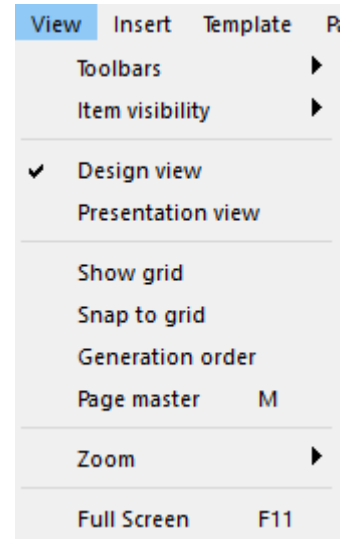

5.5.1. Item Visibility Options

Item visibility options

What of type of Items are visible on screen can be controlled by selecting or deselecting the various options in the **View -> Item visibility** menu.

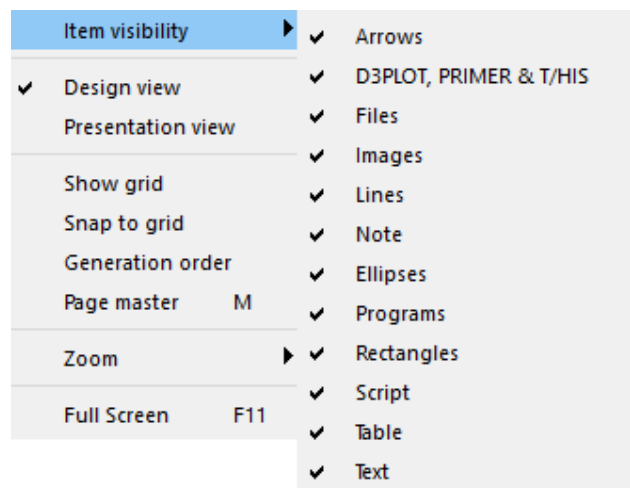

5.5.2. Design/Presentation View

Design/Presentation view

The Design view and Presentation view checkboxes allow you to swap between design and presentation view. See [Generating Reports](#) for more details.



5.5.3. Assorted Options

Assorted options

The 'show grid', 'Snap to grid', 'Generation order', and 'Page master' options are the same as those offered in the [View toolbar](#). That is, they toggle the:

- [grid visibility](#),
- [snap](#) option,
- visibility of the [item generation order](#), and,
- [page master](#) view.

The effect of toggling the visibility of the item generation order is discussed in more detail in the following section.

5.5.4. Generation Order

Generation order

The Generation order checkbox allows you to turn off whether the order that objects will be generated in is shown. The order is important if you are using variables to make sure that variables are not used before they are defined. To help with this REPORTER can show the order that the objects are generated in.

Model TITLE :	Name: program9 1
Executed on host :	Name: program11 2
CPU time :	Name: program13 3
Final % added mass :	Name: program15 4
Termination status :	Name: program17 5
Date of execution :	Name: program26 8
Model Directory :	%MODEL_DIR%
Keyword file :	%MODEL_NAME%.key

When the generation order button is turned on REPORTER shows a number next to each item that will be generated. The number is the order that the items will be generated on this page. In the image on the right you can see that the first 5 library programs in the table are generated one after another but the last one is generated later on (8th on the page). Showing the numbers helps to identify problems with objects being generated in the wrong order (e.g. perhaps the last library program should have been generated 6th on the page instead of 8th). See [Effect of object order on generating a report](#) for more details on generation order.



When the generation order button is turned off the numbers are not shown. The numbers are only shown in the design view. They are not shown in any output generated from REPORTER .

Model TITLE :	Name: program9
Executed on host :	Name: program11
CPU time :	Name: program13
Final % added mass :	Name: program15
Termination status :	Name: program17
Date of execution :	Name: program26
Model Directory :	%MODEL_DIR%
Keyword file :	%MODEL_NAME%.key

5.5.5. Zoom

Zoom

Clicking on the **Zoom** option in the **View** menu will bring up the **Zoom** menu.

- **25% 150% etc** - will zoom in or out relative to the standardised size at 100%
- **Actual size** - will resize the page to the actual size that the work is (100%)
- **Fit page** - will scale the page so that it fits into the window
- **Fit width** - will scale the page so that the width of the page will fit the screen
- **Fit height** - will scale the page so that the height of the page will fit the screen

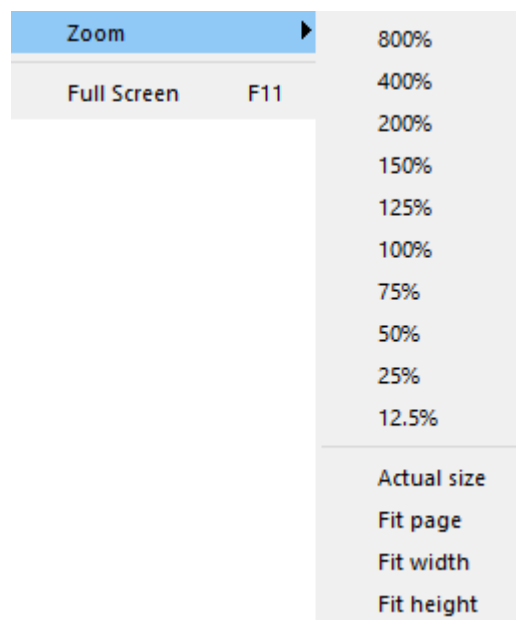

5.5.6. Full Screen View

Full screen view

The **Full screen** option in the **View** menu will enlarge the "Main report area" of the REPORTER window to fill the whole of the screen. You can return to the normal REPORTER window by pressing the **ESC** key.

5.6. Running a Script File

Running a Script file

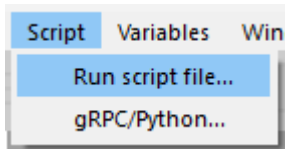

To run a JavaScript script in REPORTER use the **Script** -> **Run script file...** function. This is equivalent to running a script from the [command line arguments](#) or inserting a [script object](#) onto a page. For more details on scripting see the [JavaScript chapter](#).



5.7. Preferences

Preferences

Preferences for REPORTER can set from **File** -> **Preferences...** . Any options set in this menu will affect only this session of REPORTER unless the 'Save Preferences' button is pressed, in which case the choices made will be saved to the [oa_pref file](#) in the user's HOME directory and loaded for all future REPORTER sessions.

5.7.1. Editing

Editing

When creating or editing objects in REPORTER that occupy a rectangular area on the page the position and size of the object can be given by 2 different methods.

1. By giving the coordinates of 2 opposite corners of the rectangle.
2. By giving the coordinates of one corner and the width and height of the object.
The default is to use the bottom left corner.

The nudge distance is the amount that a selected item will be moved when the arrow keys are used. Note that if you have snap active (see [Preferences - Grid](#)) this may give unexpected results (e.g. a larger nudge than expected). If snap is active and nudge distance is smaller than snap size, nudge will automatically use the snap size as the nudge distance to ensure that nudging is always possible.

In regards to the Selection, after creating a new Item, the default behaviour is now to revert to the Select tool so that you can quickly jump to editing this Item with a double-click (or move the Item around the page etc.). If the behaviour is reverting to the Select tool, the Format toolbar will automatically be brought to the front to allow you to modify the item. If you would rather remain on the current tool (remembering that the Select tool can always quickly be accessed with the 's' key), then this option can be changed here. If the behaviour is to remain on the current tool, the Format toolbar will not be brought to the front (i.e., the Tools toolbar will remain visible).

.

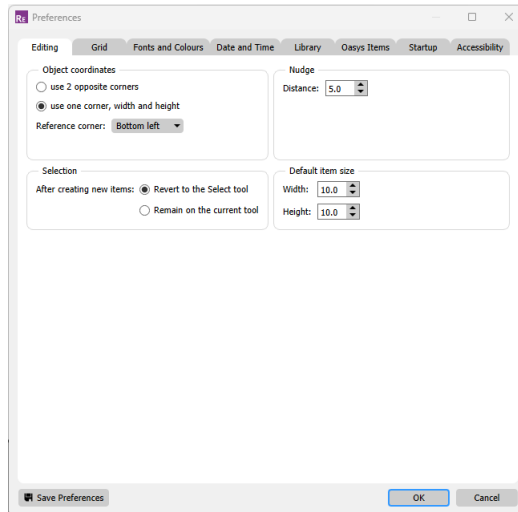

5.7.2. Grid

Grid

These options are for helping layout Items on the page.

The colour, style and size of the grid drawn on the page can be altered with these preferences. Note that the grid size does not have to be the same as the snap size.

Snap will make the reference corner coordinates round to the snap size. e.g. in the image below snap is set to 1.0mm, so item coordinates will be rounded to the nearest mm.

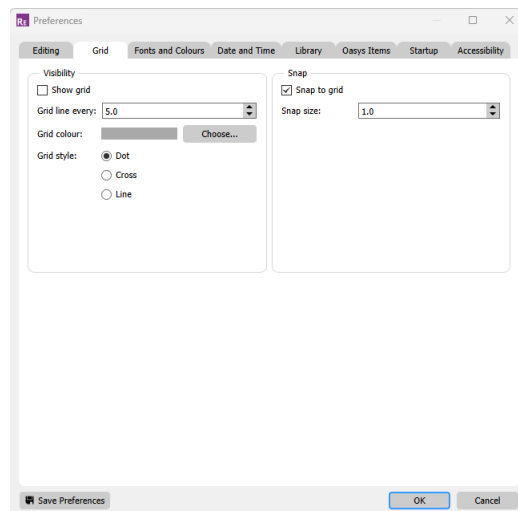

5.7.3. Fonts and Colours

Fonts and Colours



These preferences control the font cache and font mapping, including the default fonts used when no suitable alternative can be found. For more information on how REPORTER supports fonts, see [Fonts](#).

You can also control which XML file is used to store your user colours, and whether or not user colours are saved automatically on exiting REPORTER.

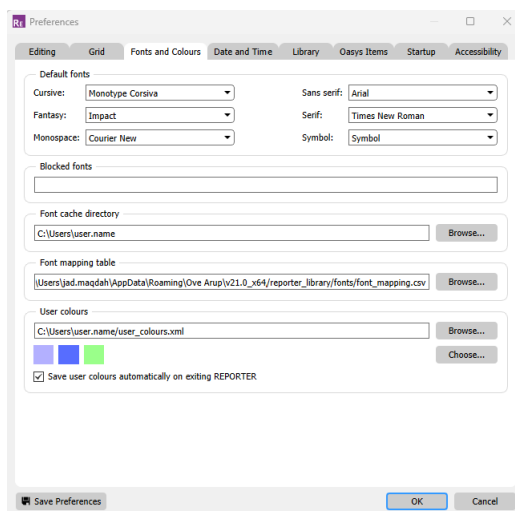

5.7.4. Date and Time

Date and Time

These preferences set the default formatting for the %DATE% and %TIME% variables. The available options are:

- %DATE% - Day Month Day Year, dd/MM/yyyy, MM/dd/yyyy, yyyy/MM/dd.
- %TIME% - hh:mm:ss, hh:mm:ss A, hh:mm, hh:mm A.

For more information about what these formatting options mean (and for further formatting choices), see [Formatting TIME and DATE variables](#).

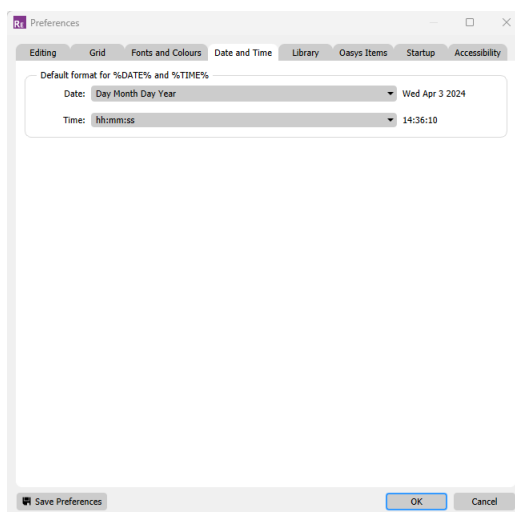



5.7.5. Library

Library

By default, REPORTER looks for library items in the subdirectories `reporter_library` and `workflows` in the directory where REPORTER is installed.

Due to file permissions, it may not always be possible to add library items to your installation location. For this reason it is possible to specify other directories for REPORTER to use in addition to the default directory. This can be done using the `reporter*library_directory` and `oasys*workflow_definitions_directory` `oa_pref` options. These options can be set once for each `oa_pref` file: one in `OA_ADMIN`, one in `OA_INSTALL`, and one in `HOME`. REPORTER will treat any directory provided via these preferences as a user defined library directory. The `oa_pref` file in `HOME` is likely the easiest to access, and is the same file to which preferences are usually saved when the 'Save Preferences' button is pressed.

In order to be read correctly, any user-defined library directory should contain subdirectories named **templates**, **pages**, and **scripts** containing their respective library items. For example, if `library_directory` is set to `/home/user/reporter_library` then you should put your scripts in `/home/user/reporter_library/scripts`.

By default, REPORTER will scan all of the directories listed. If you check **Only this**, REPORTER will scan only the specified Library or Workflows directory, and none of the directories above it (Library and Workflows are treated separately via `reporter*library_only_use_specified_directory` and `oasys*workflow_only_use_specified_directory`). This allows you to switch REPORTER to use a different directory when you customise the templates provided with the installation, or when you receive an updated bundle of templates from Oasys Ltd.

Finally, the 'Size' spinbox in the 'Image thumbnails' section controls the size of thumbnails that are drawn for library images.

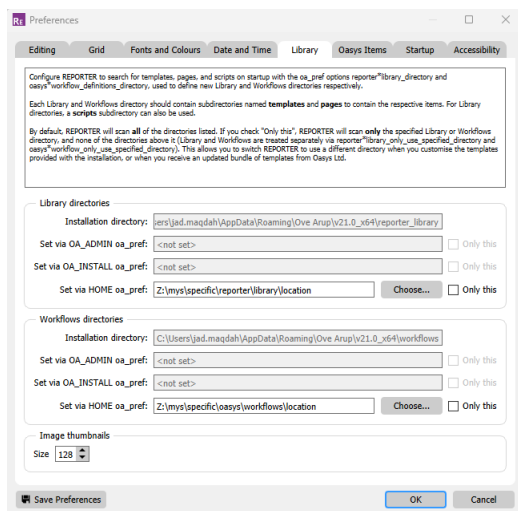

5.7.6. App items

Apps

The filename convention preference determines how LS-DYNA filenames are referred to by REPORTER in library scripts etc. If you are using Oasys SHELL then you should use Arup naming.

The program executable options would only be useful if you want to use an older version of D3PLOT , PRIMER and/or T/HIS for some reason.

If REPORTER is started in batch mode with the `-batch` [command line argument](#) then on Windows D3PLOT , PRIMER and T/HIS will be run without any windows being shown. Setting the **Run programs in batch mode** checkbox will set this option when running REPORTER interactively.

It may occasionally be necessary to pass extra arguments to D3PLOT , PRIMER or T/HIS when generating a report. Extra arguments to pass can be given in the D3PLOT , PRIMER and T/HIS **Additional arguments to pass** textboxes.

The **D3PLOT properties** options allow you to change how properties files are reloaded in D3PLOT .

By default when D3PLOT reads a properties file it only alters the blanking status of parts and elements that are in the file. Any parts that are not in the file will not be affected. The default for parts that are not in the file is to leave them unblanked. This means that if you record a properties file for one model and replay it on another model which has extra parts, the extra parts will not be blanked. With the **Blank model before reading properties file** option set D3PLOT will blank the model before reading the properties file so any extra parts not in the file will be blanked.

Older versions of D3PLOT always wrote the blanking status of elements as well as parts to the properties file, even if all of the elements in the part were blanked or unblanked and just writing the part status would be sufficient. If a properties file recorded for one



model was used for another model which had some remeshed parts then the elements in the properties file would not match the actual elements in the model for the remeshed parts. This could result in some of the elements not being blanked or unblanked correctly. With the **Ignore elements in properties files** option set D3PLOT will ignore any elements when reading the properties file and only consider parts.

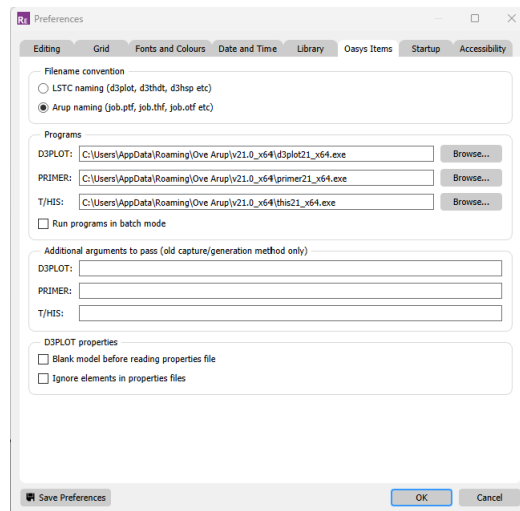

5.7.7. Startup

Startup

Here you can control whether the main window is maximised when REPORTER starts (recommended).

You can also control the directory that REPORTER starts in. By default, this is the installation directory..

Drive mappings can be changed by editing the text in the input boxes under Drive Mapping. The values used here are written to and read from the oasys*drive_x preference in your HOME oa_pref file (where 'x' can be any letter from 'a' to 'z'). These mappings are useful for being able to work with a single Template across both Windows and Unix systems.

Using the example in the image below where the Z:\ drive is mapped to /LINUX_DRIVE_2/FE_MODELS/, a REPORTER session running on Windows would silently replace the string '/LINUX_DRIVE_2/FE_MODELS/' with 'Z:\' while running commands to manipulate files (without changing the XML content of the .ortx Template file). So long as this mapping matches up with the actual drive mapping on your Windows system, REPORTER will find the correct files without complaint. This also works in the other direction (replacing 'Z:\' with '/LINUX_DRIVE_2/FE_MODELS/' when running REPORTER on Linux).

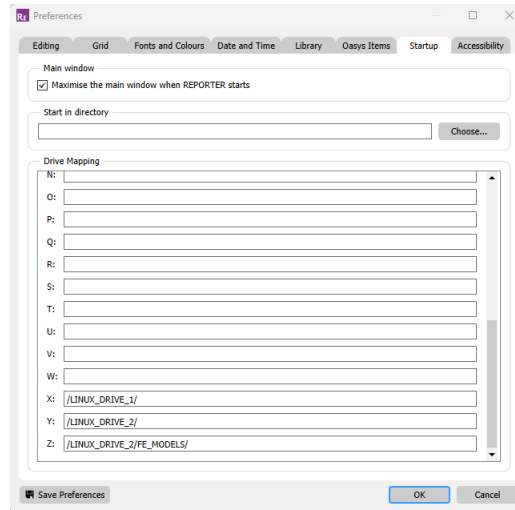

5.7.8. Accessibility

Accessibility

Here the GUI theme for REPORTER can be set. Legacy is deprecated and we do not recommend its usage. Light is the default theme, with Dark providing an alternative experience for users. For more information on Themes, see [Themes for the Graphical User Interface](#).

You can also set whether you want to view the manuals online or via your local copy and set your preferred application that will be launched when opening a PDF or HTML file from REPORTER.



RE Preferences

Editing Grid Fonts and Colours Date and Time Library Oasys Items Startup Accessibility

GUI Theme

Light*

Dark

*In REPORTER, the Classic and Light themes are the same.

Manuals

Preferred method of opening Help and Manuals:

Online

Local

PDF Application:

HTML Application:



6. Opening and Closing Templates and Reports

Opening and closing templates and reports

Templates can be created, opened, or saved by either using the **File** menu or the **File Buttons**

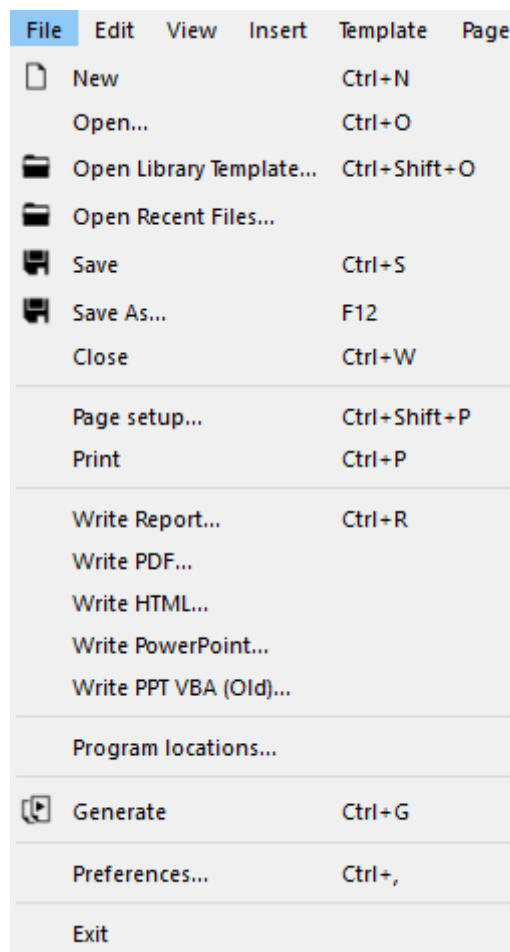

6.1. Creating a New Template

Creating a new template





A new template can be created from either the **New file** option in the **File** menu or by using the **New file** button.

6.2. Reading an Existing Template or Report

Reading an existing template or report



An existing report template can be opened from either the **Open file** option in the **File** menu or by using the **open file** button.

6.3. Reading a Library Template

Reading a library template

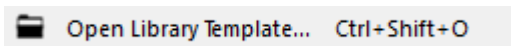

When REPORTER starts, the **Choose a Template** window is shown, allowing you to open a file from the recent files list or to select a template from the library. Library templates are presented on different tabs. The **Standard** tab has some standard layout templates to help you start creating reports, and to provide some inspiration. The **Automotive** tab has a number of built in templates to create reports for standard automotive crash test protocols (EuroNCAP, IIHS etc.). You can also open the **Choose a Template** window at any time with **File** → **Open Library Template** .

In the **Choose a Template** window, select a template by clicking on its thumbnail with the mouse and then clicking **OK** to open the template. You can also double-click on templates to open them immediately. The **Cancel** button will exit you from this window without opening a template.

The options presented to you when using the **Choose a Template** window will match the filters ticked in the checkboxes.

Pressing **New File** will open a new template with a blank portrait A4 page.

Pressing **Open File...** will allow you to open a template or report from elsewhere on your system.

The Recent Files section contains a list of your most recently accessed templates and reports. Pressing **Clear recent files** will delete this list (the files themselves will not be deleted).

As well as using the library templates supplied with REPORTER , you can create your own library of templates. If you [add tags](#) to your templates and save them to a common directory, you can add them as a library by pressing **Add library...** . This will open the



[Library](#) tab of the Preferences menu, allowing you to include your directory of templates. For example, at Arup, we have a library of templates all tagged with **Type: Arup** so that they all appear together in an "Arup" tab for easy access.

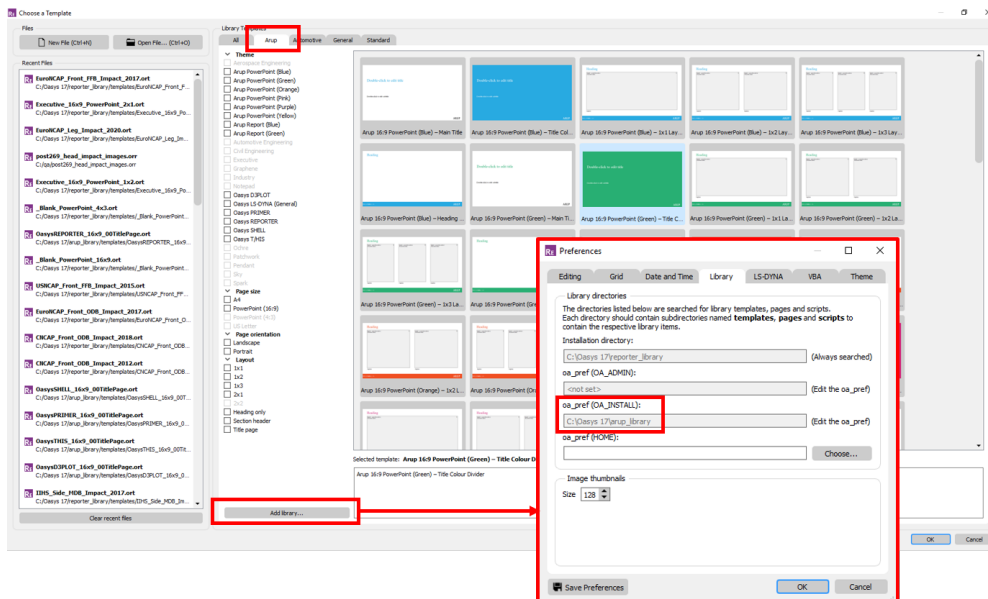

6.4. Editing Template Properties

Editing template properties

The Edit Template Properties window can be accessed by selecting **Template → Template properties...**

Properties

The Properties section contains the Title and Description for the current template which can be freely changed. The Read-Only property is immutable and signals whether the template can be overwritten. For library templates it is always checked; for user-made templates it is unchecked.

Tags

The tags list provides information about the current template that is used for filtering in

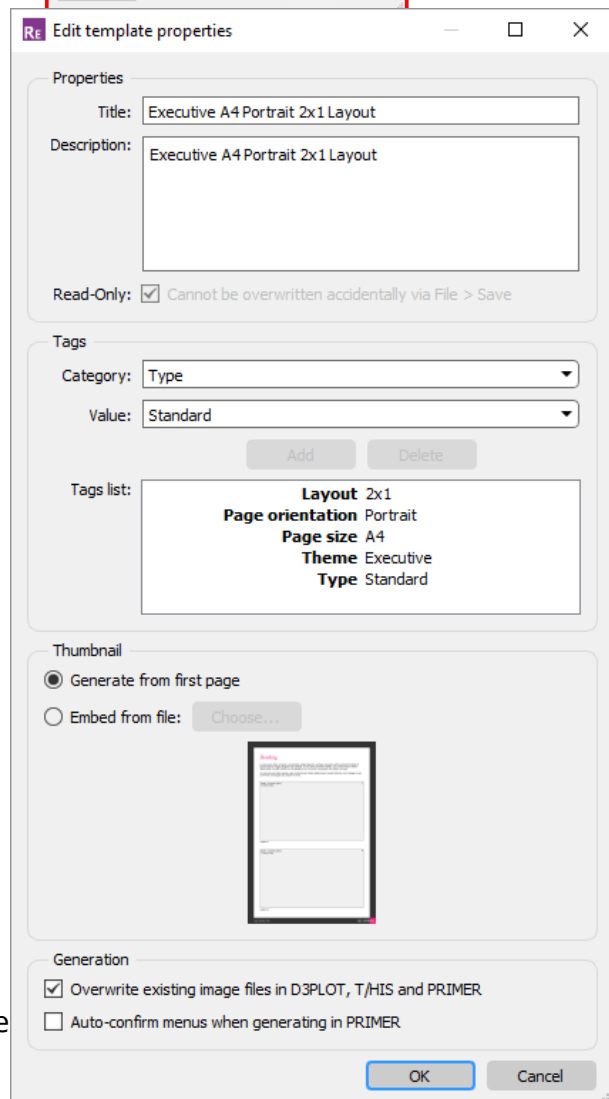



the Choose a Page / Template windows. Tags can be added to the list by selecting a category and value from the drop-down menus and pressing **Add** . User-defined category-value pairs may also be added by typing directly into the Category and Value boxes instead of using the drop-down buttons. Tags can be deleted from the list by selecting them from the Tags list panel and pressing **Delete** . The **Type** category determines the tab in which the template appears in the **Choose a Template** window.

Thumbnail

The thumbnail determines the image that is shown to represent the template in the Choose a Template window. This can either be generated from the first page of the template, or embedded from a separate file.

Generation

When generating image files for D3PLOT and T/HIS the **Overwrite existing image files** preference controls what do do if an image with the same name exists. By default (selected) REPORTER will overwrite the image. However, you many want to run the same template multiple times for different models in the same directory. With this unselected a new image will be created for each model.

The **Auto confirm menus** preference controls how macros are replayed when generating a PRIMER object. When creating or updating a PRIMER object, REPORTER ensures that the **MENU_AUTO_CONFIRM** environment variable is unset so that any listing boxes created are not automatically dismissed. However in version 16.0 and earlier when generating a PRIMER object REPORTER would set the **MENU_AUTO_CONFIRM** environment variable. In some instances this could mean that the macro recorded in the object would not play properly (as when it was recorded the **MENU_AUTO_CONFIRM** environment variable was not set). From version 16.1 onwards by default REPORTER will now not set the **MENU_AUTO_CONFIRM** environment variable when generating PRIMER objects to be consistent. There may be very rare cases where this needs to be set when generating, in which case the **Auto confirm menus** preference can be used.

These preferences are not programme wide preferences. They are actually stored with the template and read/written as properties so they must be set for each active template.

6.5. Saving a Template

Saving a template



A template can be saved by choosing the **Save as** option in the **File** menu and then changing the file type to **template** .



6.6. Saving a Report

Saving a report

A report can be saved by using the **Save as** option in the **File** menu and setting the file type to **report**. The difference between a report and a template is that a template is the instructions or recipe of how to construct the report. To actually create the report you have to generate it and then create some sort of output. This could mean running D3PLOT command files, programs, FAST-TCF scripts etc.

Alternatively, once the report has been created you can save the whole thing as a report. This saves the output of programs, command files etc. with the template so when you next read the file the results are already available (the report does not need to be regenerated).



6.7. A Note on REPORTER's File Formats

Upgraded Templates and Reports

With the release of REPORTER 20.0, new file formats have been introduced for Templates and Reports. These formats use the `.ortx` and `.orrx` file extensions respectively, and replace the older `.ort` and `.orr` formats (now marked as "[LEGACY]").

Our new file formats are similar in structure (but not identical) to the Office Open XML format; essentially a ZIP archive containing various XML files and additional multimedia content.

The reasons behind these changes are twofold:

1. To improve our support for the [handling of multimedia content](#) (like MP4 and GLB) in REPORTER
2. To produce a format that is ready-for-use with our new online [Report Viewer](#).

No changes to your existing workflows should be necessary. The new file formats should perform as direct replacements for their older counterparts.



7. Inserting and Editing Pages

Inserting and editing pages

A report is generally made up of a number of different pages. Only one page is shown on the screen at any one time. Moving through the pages of the report, adding, deleting, and reordering pages are all controlled from the **Page** menu.

Some of the options within the **Page** menu are also available from the Page toolbar.

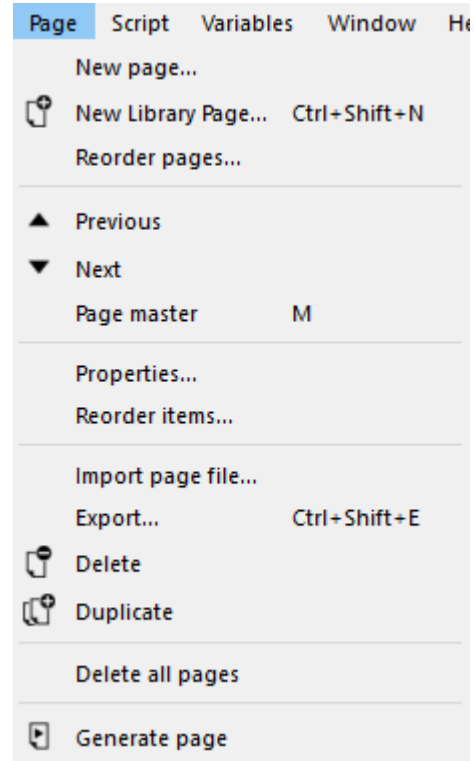
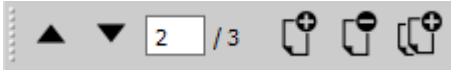

7.1. Adding a New Page

Adding a new page

A new blank page can be added by using the **New page** option in the **Page** menu. This will bring up a **Page layout** window from which you can give the new page a title, and set the background colour.

Choose... can be used to pick the background colour for the page. Alternatively pressing **Master** will make

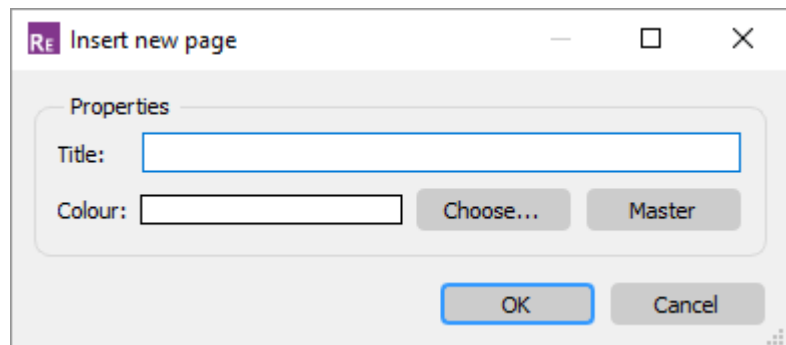



the page inherit the colour
from the master page.

7.2. Adding a New Page from the Library

Adding a new page from the library

A new page can also be added by selecting an existing page layout from the library by using the **New Library Page...** option in the **Page** menu (or toolbar) or by right-clicking on one of the page thumbnails in the **Page Navigation** bar and selecting **Insert page after...** or **Insert page before...**

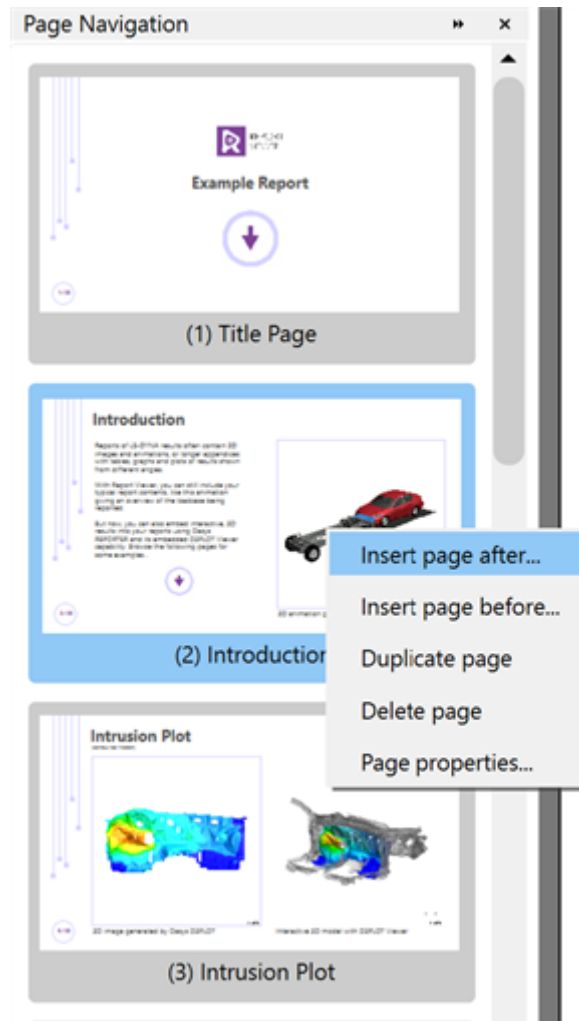

This will bring up the **Choose a Page** window from which you can select a page layout. Highlight the page layout you want by clicking on its thumbnail with the mouse and then clicking on then **OK** button to create the new page. The **Cancel** button will exit you from this window with out creating a new page.

The options initially presented to you when using the **Choose a Page** window will match the Template Properties of the current template. For example, in the image below we are currently using the Executive 16:9 Landscape Title Page template in REPORTER . Thus when the **Choose a Page** window is opened the Executive, PowerPoint (16:9), and



Landscape filters are all ticked in the tree on the left, and the library page thumbnails on the right all match these filters.

Pressing **New Empty Page** will add a new blank page to your template with the same size and orientation as the current page.

Pressing **Import Page...** will allow you to add an existing page to your REPORTER page library.

Pressing **Add library...** will open the [Library](#) tab of the Preferences menu.

When adding a page to your template or report via the **Page** menu (or toolbar), the page will be placed after the current page by default. However, if you add a page via the **Page Navigation** bar, the placement of the page depends on your action. If you press on **Insert page before...**, the added page will be placed before the page on which you carried out the action. If you press on **Insert page after...**, the added page will be placed after the page on which you carried out the action.

See the [library object appendix](#) for more details on using the library.

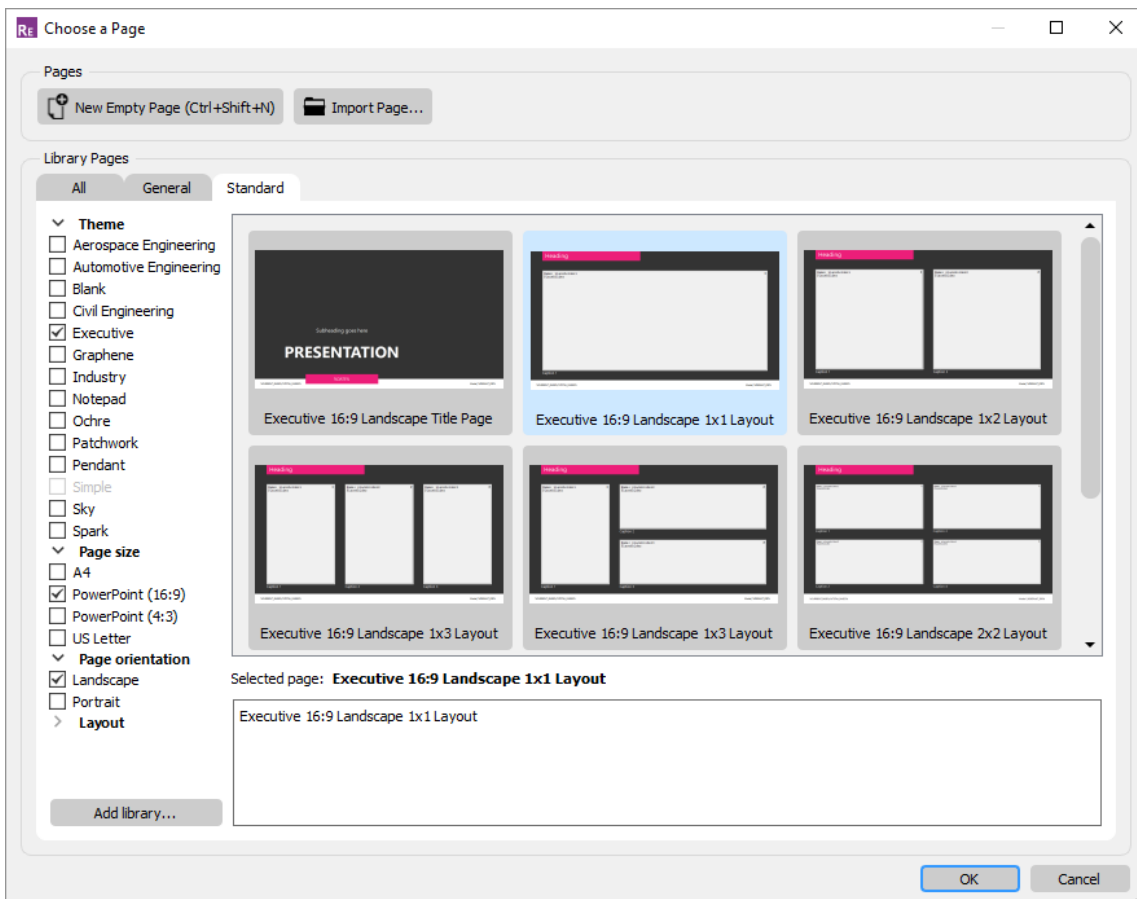



7.3. Deleting Pages

Deleting pages

You can delete the present page you are working on by using the **Delete page** option in the **Page** menu (or toolbar), or you can delete all the pages in the report template by using the **Delete all** option in the **Page** menu. You can delete any page by right-clicking on its thumbnail in the **Page Navigation** bar and pressing the **Delete page** action. All of these options will bring up a confirmation window in which you need to confirm the delete operation.

7.4. Duplicating Pages

Duplicating pages

You can copy the current page by using the **Duplicate page** option in the **Page** menu (or toolbar) or copy any page by right-clicking on the page's thumbnail in the **Page Navigation** bar and pressing **Duplicate page**. This will make a copy of the page, and insert it after that page. The current page will also be changed to this newly created page.

7.5. Reordering Pages

Reordering pages

You can change the order of the pages in the report by using the **Reorder pages** option in the **Page** menu. This will bring up the reordering window.

The pages are listed by the page number and title. The page order can be modified by clicking on the page you want to move in the **Pages** box. This will highlight that page, which can then be moved by using the **Move up** and **Move down** buttons. Once finished the **OK** button will save the new order and exit the window. The **Cancel** button allows you to exit this window without making any changes to the page order.

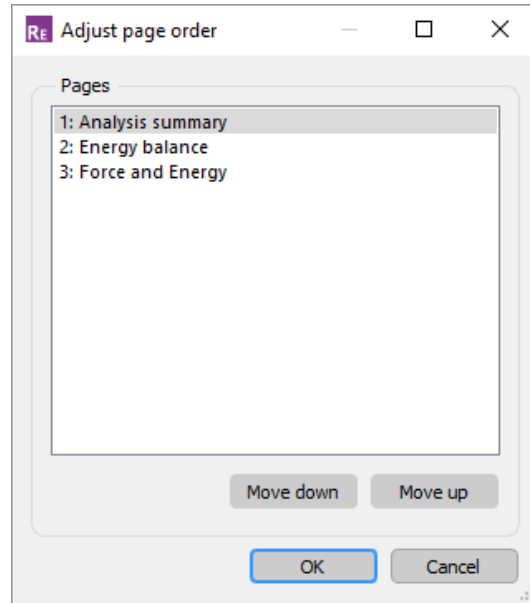

Alternatively, you can re-order the pages in the report by dragging and dropping the page thumbnails in the **Page Navigation** bar.

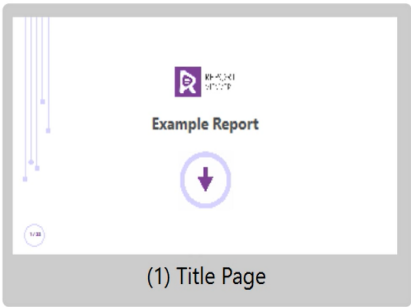

(1) Title Page

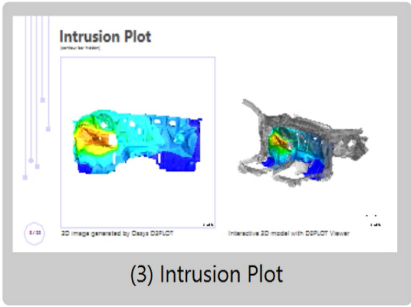

(3) Intrusion Plot

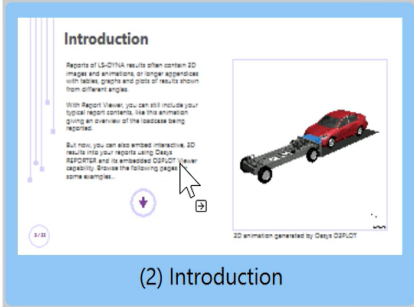

(2) Introduction

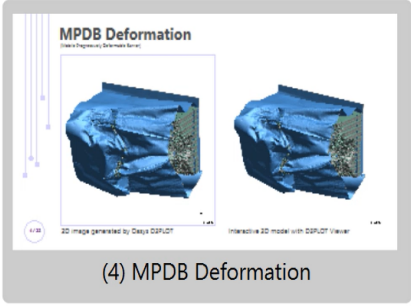

(4) MPDB Deformation





7.6. Changing the Current Page

Changing the current page

You can change the current page you are working on by using the **Prev page** and **Next page** option in the **Page** menu (or toolbar) to change the current working page to the previous or next page in the report. You can change the current page to a specific page in the report by pressing on a page's thumbnail in the **Page Navigation** bar. You can also move through the pages by using the `Page Up` and `Page Down` keys. If you have a mouse which has a wheel then the wheel can also be used to move through the pages.

7.7. Changing the Page Properties

Changing the page properties

You can change the title of the current page by using the **Properties** option in the **Page** menu. This will bring up an edit page properties window. The new page title is entered into the **Title** text box and the colour can be changed by clicking on

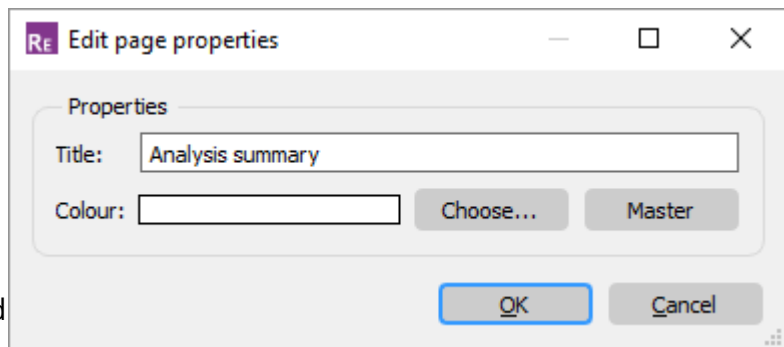

the **Choose** button. Pressing **Master** will make the page inherit the colour from the master page.

You can also change the properties of any page by right-clicking on any of the page buttons in the **Page Navigation** bar and pressing on **Page properties...**

Clicking on the **OK** button will save the changes and exit this window.

The **Cancel** button will exit this window with out making any changes to the page title.

7.8. Inserting Pages from File

Inserting pages from file

You can insert multiple pages from a template (`.ort`) or report (`.orr`) as well a single pages (`.orp`) into the current template using the **Import page(s) from file...** option on the **Page** menu, and then selecting the required file (`.ort`, `.orr` or `.orp`) from the **File** window.



7.9. Importing and Exporting Pages

Importing and exporting pages

Individual pages can be exported from a template using the **Export page** option. These pages can then be used in the [page library](#) or can be imported into another template by using the **Import page(s) from file...** option on the **Page** menu. Individual pages should be saved with the extension `.orp` so REPORTER can find them.

7.10. Page Masters

Page masters

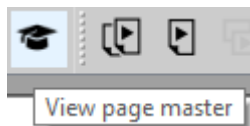

Page masters can be used to automatically add objects to every page in the report. For example you may want to have your project name written on the bottom right corner of every page in the report. You could do this by having a standard page and either use the [page library](#) or [import it](#) each time you want to create a new page. This will work, however if in the future you want to edit the project name, you would need to edit each page individually.

An alternative is to use page masters. A page master is a type of template used to keep each page looking the same (eg such as using a company logo). Each REPORTER template has one associated master page and any objects that you put on that page will automatically appear on every page in the template.

The master page is accessed via a toggle, either by clicking on the page master icon (see image on the right), pressing the 'm' key, or using **View ... Page master**. From within this view, the master page can be edited in exactly the same manner as you would interact with a normal page. To close the master page and return to the normal page view, simply click the toggle as before.

7.11. Page Setup

Page Setup

To set up the page settings choose the **Page setup** option from the **File** menu. This allows you to change the page size and orientation. If the page size and/or orientation is changed objects on existing pages are automatically moved to ensure that they are not outside the page boundaries.

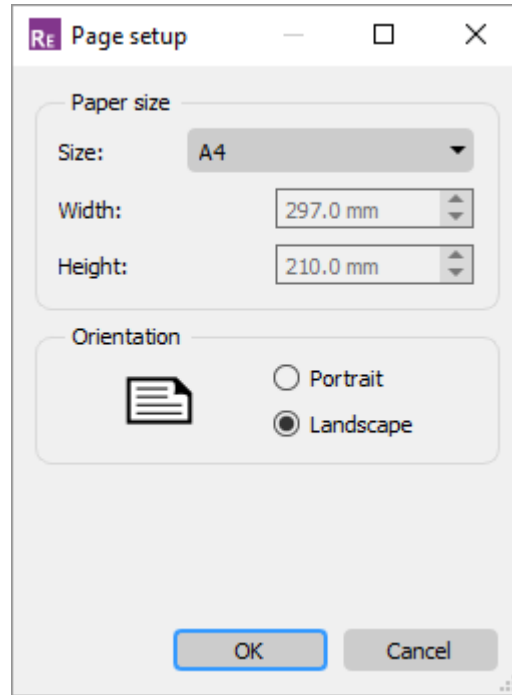

7.12. Generating a Single Page

Generating a single page

Instead of generating the entire report you can generate a single page by using the **Generate page** option in the Page menu (or Generate toolbar). However, note that if some of the objects on the page require data that would be generated on previous pages and those pages have not yet been generated the page generation will not work.



8. Inserting and Editing Simple Objects

Inserting and editing simple objects

REPORTER allows you to create and edit a number of different shapes through the use of the various **Tools** and **Style** button options.



8.1. Using the Grid and Snap Options

Using the Grid and Snap options

Grid



The grid option can be turned on by clicking on the **Grid** button. This will create a grid of dots on the screen with a pitch equal to the grid size, this is to help you in aligning objects in the report. These dots will not appear in the generated report. The size and attributes of the grid can be modified by using the **Grid** tab in the [preferences](#).

Snap



The snap option can be turned on by clicking on the **Snap** button. This will create an invisible grid with a pitch equal to the snap grid size. When positioning and sizing object the point you select will not be the exact position of the mouse pointer but the nearest point on the snap grid.

The size and attributes of the grid can be modified by using the **Editing** tab in the [preferences](#).



8.2. Setting Line Style, Thickness, Colour and Fill Colour

Setting line style, thickness, colour, and fill colour

When you select an object the Style widget buttons are updated with the properties of the selected object. Changing any of these while an object is selected will change the property of the object.

Line style

The line style can be set using the **Line style** button (top button in the Style widget). Clicking on this will bring up a **Line style** window from which the line style can be selected.

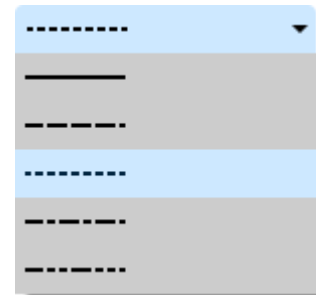

Line thickness

The line thickness can be set by clicking on the **Line thickness** button (second from top in the Style widget). Clicking on the button will bring up a **Line thickness** window from which the line thickness can be selected.

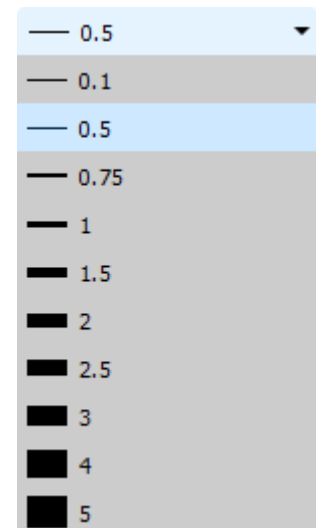

Fill, Line and Text Colour

The fill, line or text colour can be set using the **Fill colour** button, the **Line colour** button or the **Text colour** button, the current colour is displayed to the right of the button:

Clicking on this will bring up the **Colour** window.

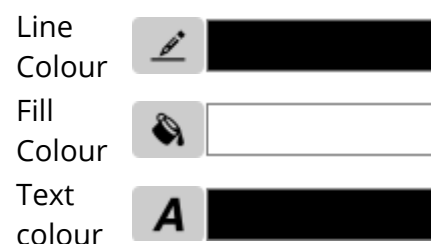

The new colour can be selected from those on display or by clicking on the **More colours** button a set of red, green, and blue sliders can be brought up which you can use to create your own new colour. For the Fill colour you can also select **no colour** which will give you a transparent Fill colour allowing object below to show through. The **Done** button will exit this window setting the fill or line colour to the new colour. The **Cancel** button will exit you without changing the colour.

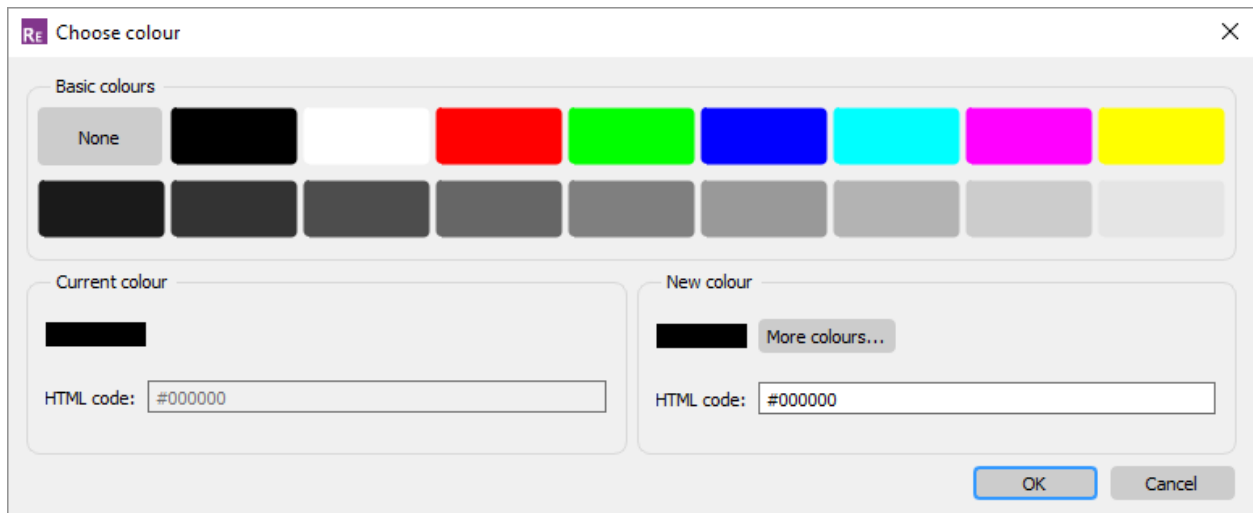

8.3. Inserting and Editing Shapes, Images and Text

8.3.1. Lines and Arrows

Lines and arrows



You can create a line or arrow by using the **Line** and **Arrow** tools.

To create a line click and drag the mouse from the point you want the line to start from to the point you want the line to end at. It is the same procedure for creating an arrow with the arrow head appearing at the end point of the line. The line type, thickness, and colour will be set to the current settings.

8.3.2. Rectangles

Rectangles



You can create a box by using the **Rectangle** tool.

To create a box click and drag the mouse from one corner of the box to the other. If the `shift` key is held down while doing this a perfect square can be created.

If the `ctrl` key is held down then the initial click position will be the centre of the rectangle instead of one corner. The line type, line thickness, line colour, and shape fill colour will be set to the current settings.



8.3.3. Ellipses and Circles

Ellipses and circles



You can create an ellipse or circle by using the **Ellipse** tool.

To create an ellipse click and drag the mouse from one corner to the other of a rectangle into which the ellipse will be drawn. If the `shift` key is held down while doing this a perfect circle can be created. If the `Ctrl` key is held down then the initial click position will be the centre of the ellipse instead of one corner. The line type, line thickness, line colour, and shape fill colour will be set to the current settings.

The edit window for the **Line**, **Arrow**, **Item** and **Ellipse** Items simply allow you to edit their geometry (e.g. as can be seen in the image on the right for an **Ellipse**).

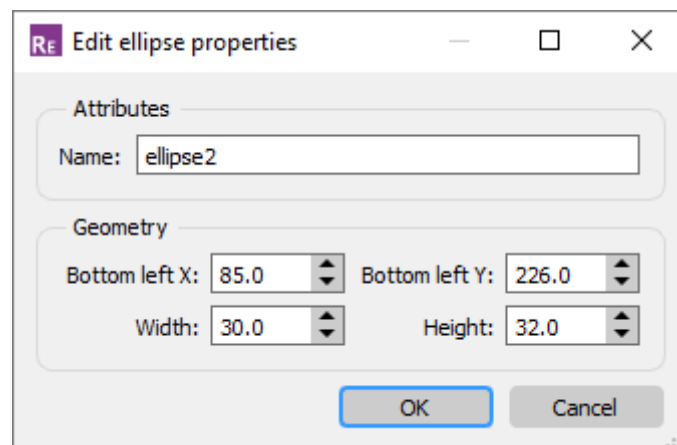

8.3.4. Text

Text



A single line of text can be added by using the **Text** tool.

To add text click on the point you want the text to be, this will bring up a **Text** window.

Text can be added using the **Enter text** box. You can also enter variables in the text by right clicking in the text box or pressing **Ctrl+I** which will allow you to bring up an **Insert variables** window from which to select a variable.



The font, style, and size are set in the relevant boxes.

The horizontal and vertical justification of the text can be set independently to enable you to position the text how you want. Changing the vertical alignment can help when trying to align text with program items.

The text colour will be set to the current [text colour](#) setting. The **OK** button will exit this window and create the text. The **Cancel** button will exit this window without creating any new text. Also a **Hyperlink...** button (see [Hyperlinks](#)) allows the user to set the text up as hyperlink and the **Conditions...** button (see [Conditional Formatting](#)) enables the user to apply conditional formatting to the text.

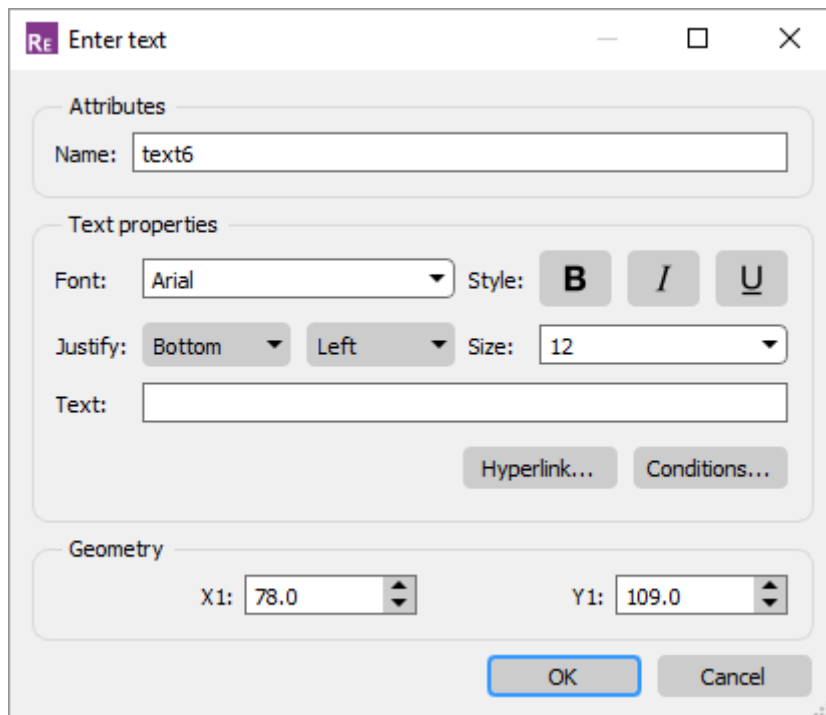

8.3.5. Textbox

Textbox



Text inside a box (with multiple lines if necessary) can be added by using the **Textbox** tool.

To add a textbox click and drag the mouse from one corner of the textbox you want to create to the other. This will bring up a **Textbox** window.

Text can be added using the **Text** box. You can also enter variables in the text by right clicking in the text box or pressing **Ctrl+I** which will allow you to bring up an [Insert variables](#) window from which to select a variable.



The font, style, and size are set in the relevant boxes.

The horizontal and vertical justification of the text can be set independently to enable you to position the text how you want.

The text colour will be set to the current line colour setting. The **OK** button will exit this window and create the text. The **Cancel** button will exit this window without creating any new text. Also a **Hyperlink...** button (see [Hyperlinks](#)) allows the user to set the text up as hyperlink and the **Conditions...** button (see [Conditional Formatting](#)) enables the user to apply conditional formatting to the text.

The background and border colour for the textbox can be set using the [fill and line colour buttons](#) in the [style toolbar](#). The border style can also be set with the [line style](#) and [line thickness](#) buttons in the [style toolbar](#).

The margins for the textbox can be changed by using the [Margins... button](#).

Margins

The Edit margins dialogue box allows you to change the margins around the text in a textbox.

The margins can be set independantly for the top, bottom, left and right sides of the textbox.

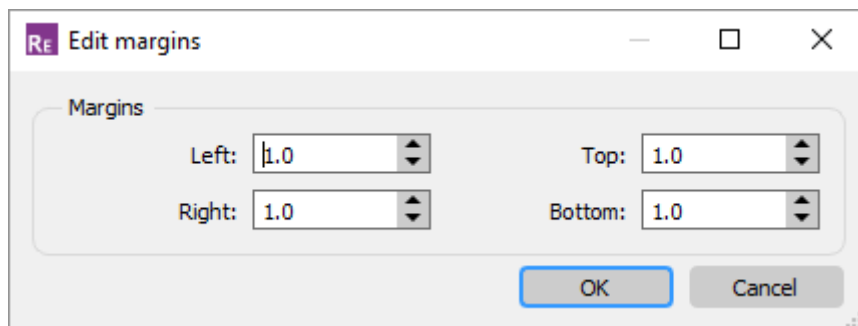

8.3.6. Images

Images



PNG, Bitmap, GIF, and JPEG images can be added using the **Images** button.

To add an image, click on the point where you want the bottom left corner of the image to be. This will bring up an **Image** window.



Enter the image filename into the **Image** text box or click on the **Choose...** button to call up a **File** window from which to select the image file. You can also enter variables by right clicking in the text box which will allow you to bring up an **Insert variables** window from which to select a variable.

The **OK** button will close this window and add the image to the page.

The **Cancel** button will exit this window without adding an image.

The **Cropping...** button (see [Image Cropping](#) below) can be used to crop the image before showing it. Also the **Hyperlink...** button (see [Hyperlinks](#)) allows the user to set the image up as hyperlink.

The **embed image in template** checkbox allows you to embed the image file directly in the template. If this option is selected, REPORTER will display the image from the embedded data rather than searching for the external image file. This feature can be useful when sharing templates with users who do not have access to the original image files. For example, if you create standard templates for users in your organisation, you could embed the company logo image so that you do not need to supply the image file along with the template file.

We recommend that where users have access to the image files, you continue to use the image file link (rather than embed) because this reduces the template file size and means that templates will automatically update if changes are made to the source files.

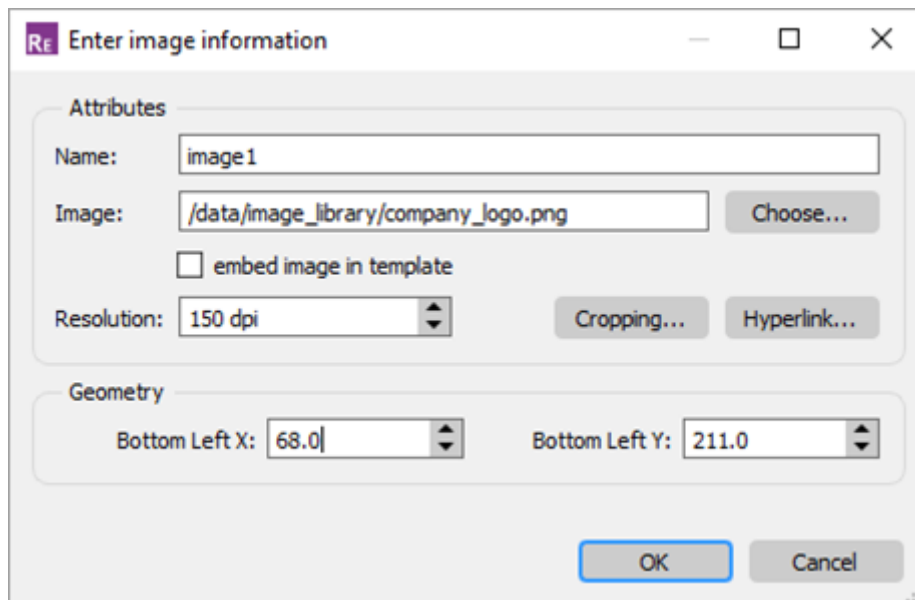
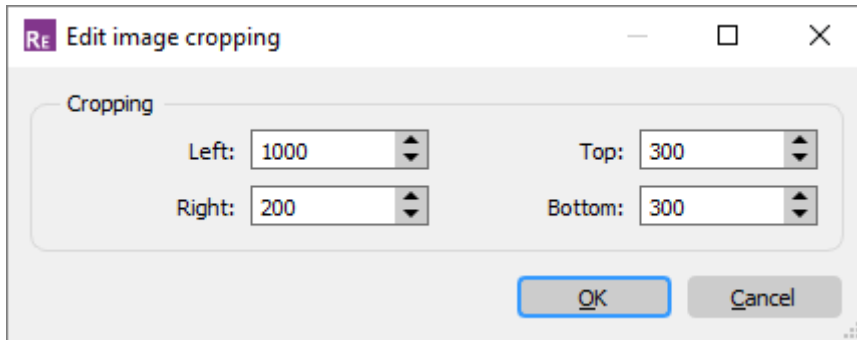

Image cropping

The **Cropping...** button allows you to crop parts of the image before it is shown. Pressing the button maps the panel shown on the right. This allows you to input how many **pixels** will be cropped from the left, right, top and bottom of the image before showing it. Type the values or use the up and down arrows to set the values you require.

Pressing **OK** will update the cropping information for the image. Pressing **Cancel** will abort without changing the values.



Animated Images

From version 18.0, **Image** Items using the .gif or .mp4 extension can now be animated on the page. These Items can be added to the page through the **Image** window in exactly the same process as described above, although the **Cropping** and **Hyperlink** features are disabled for animated Items. It is still possible to **embed** a .gif Image in the Template.

Playback of the animated **Image** can be controlled using either the buttons in the **Animation toolbar**, or by hovering over the Image with the Hand tool while in Presentation view. Hovering over the animated Image will display a border around its perimeter and centred **Playback buttons**, as can be seen in the image on the right. For animated GIFs, only the Play/Pause button is present while hovering. Clicking anywhere on the Item is sufficient to toggle Play/Pause.

Please see the section on [animation support for output file formats](#) to see how animations will be displayed when producing different types of output content.

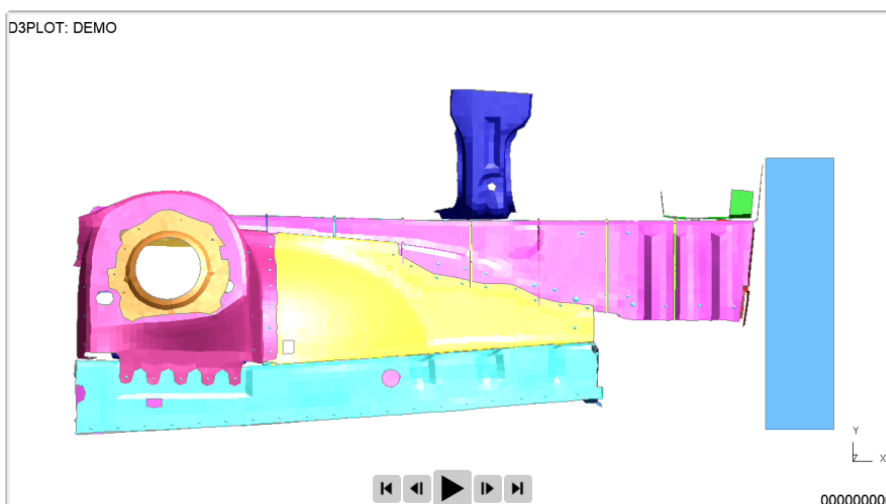



8.4. Editing Shapes, Image and Text Objects

Editing shapes, image, and text objects



You can edit a existing shape, image, or piece of text by first clicking on the **Select** tool to select the editing tool and left clicking on the object. Multiple objects can be selected by holding down the SHIFT or CTRL keys when clicking on the objects, or by left click mouse dragging a selection box around multiple objects. The object(s) are then drawn with blue boxes or "handles" which allow you to resize the object(s). Additionally the cursor changes to indicate that you can now move the object(s). If you click and drag when over the object(s) you can move them around the page. The cursor keys can also be used to "Nudge" the items around. If you move the mouse over one of the blue "handles" you can resize the object(s). The cursor changes appropriately to indicate how the object(s) will be resized. The escape key can be used to deselect all currently selected objects.

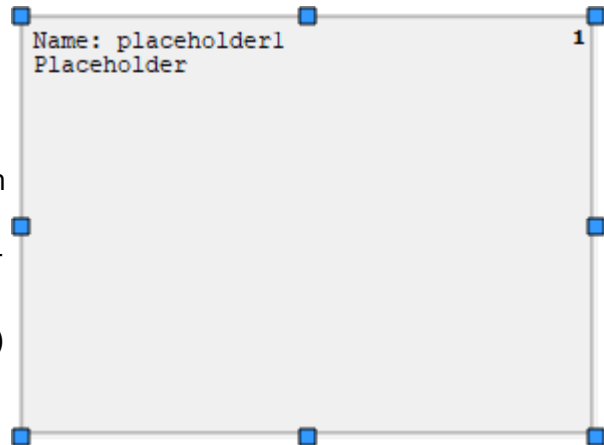

You can also right click on an object regardless of the mode the cursor is in. If the object is not already selected, it is selected and then a [popup menu](#) is displayed.

Right clicking when editing an object will bring up a small popup

- **Edit** will bring up an **Edit** window for the object. The **Edit** depending on what type of object is being edited.
- **Convert Into** allows you to transform one object into another, retaining the same dimensions.
- **Cut** will cut the object(s) from its current page/place and make them available to be pasted in another place.
- **Copy** will make a copy of the selected object(s) and keep them stored in the computers memory until they are pasted or another item is copied.
- **Save** will save a copy of the object(s). This can then be imported elsewhere using **Edit Import...** .

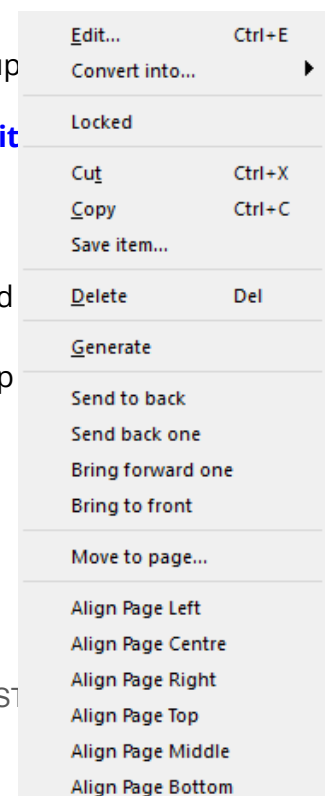

- **Delete** will delete the object(s). This can also be done by pressing the `Delete` key while editing the object(s).
- **Locked** allows you to lock an item on the page so it cannot be moved by dragging with the mouse. See [Locking Items](#) for more details.
- **Active** allows you to toggle whether an Item can be Generated or not.
- **Generate** will perform any actions required to make the output for the object(s). See [Generating Reports](#) for more details.
- **Send to back** will send the selected item(s) behind all the rest of the items on the page.
- **Send back one** will send the selected item(s) behind the next item behind it.
- **Bring forward one** will bring the selected item(s) in front of the next item in front of it.
- **Bring to front** will bring the selected item(s) in front of all other items on the page.
- **Move to page** will move the selected item(s) to the same location(s) on a chosen page.
- **Align Page Left** will align the selected item(s) horizontally with the left hand side of the page.
- **Align Page Centre** will centre the selected item(s) horizontally on the page.
- **Align Page Right** will align the selected item(s) horizontally with the right hand side of the page.
- **Align Page Top** will align the selected item(s) vertically with the top of the page.
- **Align Page Middle** will centre the selected item(s) vertically on the page.
- **Align Page Bottom** will align the selected item(s) vertically with the bottom of the page.

Also note that some of these options are also available through the **Edit** menu.

When multiple items are selected, you also get the following options on the popup menu

- **Align Left** will align the selected items horizontally with the left most selected item.
- **Align Centre** will centre the selected items horizontally with respect to the left most and right most selected items.
- **Align Right** will align the selected items horizontally with the right most selected item.
- **Align Top** will align the selected items vertically with the top most selected item.
- **Align Middle** will centre the selected items vertically with respect to the top most and bottom most selected items.

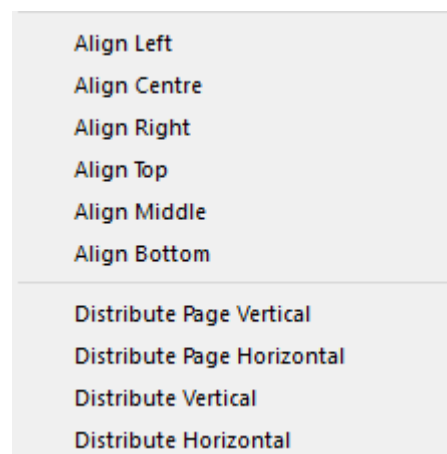



- **Align Bottom** will align the selected items vertically with the bottom most selected item.
- **Distribute Page Vertical** will evenly distribute the selected items vertically on the page.
- **Distribute Page Horizontal** will evenly distribute the selected items horizontally on the page.
- **Distribute Vertical** will evenly distribute the selected items vertically between the top most and bottom most selected items.
- **Distribute Horizontal** will evenly distribute the selected items horizontally between the left most and right most selected items.



8.5. Copying Objects and Using the Clipboard

Copying objects and using the clipboard

If you want to copy the object to another page, select the item and use the **Copy** option from the **Edit** menu. This copies the object onto the 'clipboard'.

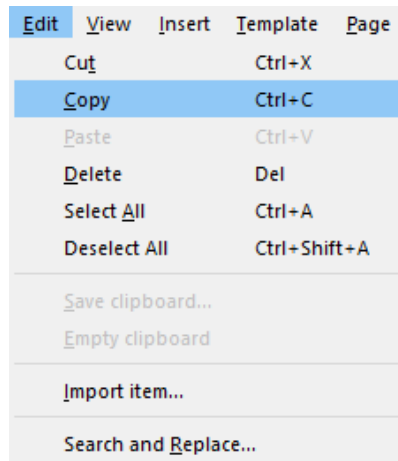

Once you have an object on the clipboard you can **Paste** it onto any page in the template (including the page that you copied the object from). If you paste the object back onto the same page the object will be offset slightly. If you paste the object onto a different page it will be placed in the same position on the page.

You can also right click on the page at any point and then select **Paste item here**. This will paste the item at the current cursor location.

Alternatively you can save the object to a file by using the **Save clipboard** function. Currently only a single object can be saved. Objects saved from REPORTER should be given the extension `.oro` (REPORTER Object).

Empty clipboard will remove any objects from the clipboard.

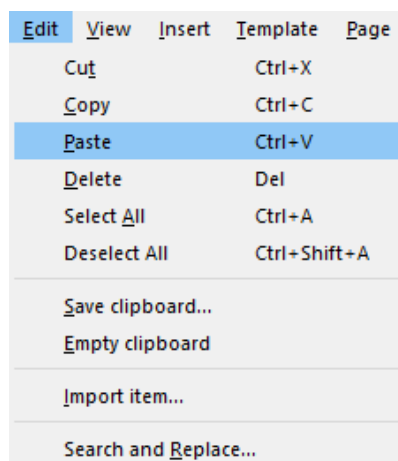



To import an object (that has previously been exported from the clipboard) use the **Import item...** option in the **Edit** menu.

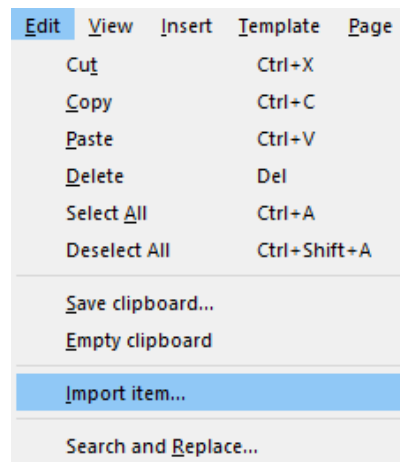

8.6. Reordering Items on the Page

Reordering items on the page

The order in which items are drawn on the page can be changed by 2 different ways in REPORTER . The order is important as it determines the order in which scripts, programs etc will be run. For more details see [Effect of object order on generating a report.](#)

The first method can be used when editing [objects](#) . Once an item is selected you can right click with the mouse and use the ordering options in the popup to change the object.

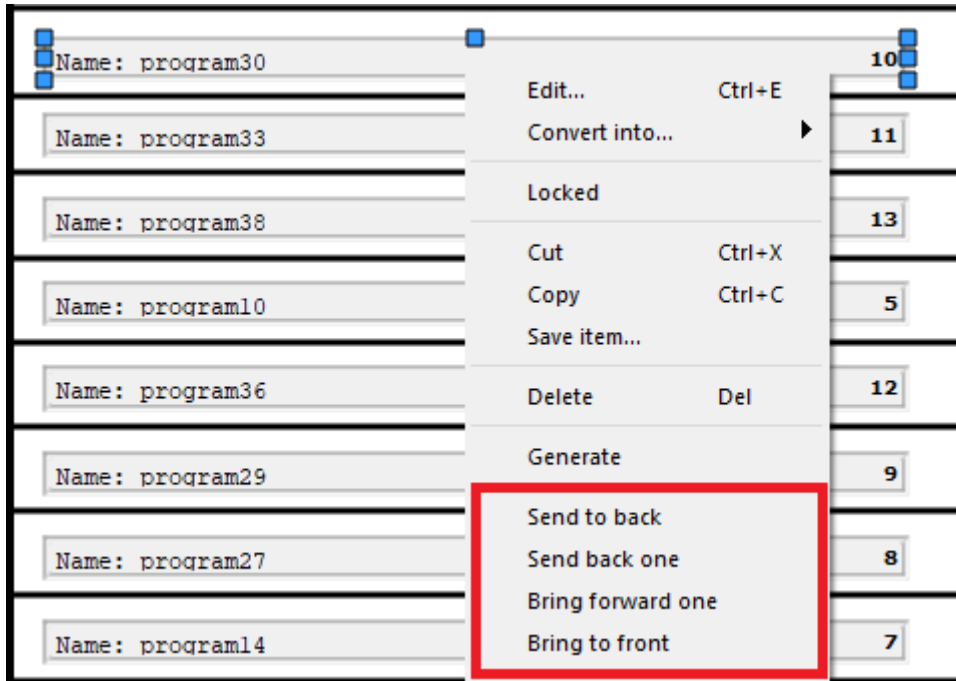

One way of thinking about the object order is to think of a series of 'layers' or transparencies in a stack. Each 'layer' or transparency contains one object. The order in which the transparencies are stacked changes the order in which things are seen. This is exactly the same as layers in various photo editing software.

Send to back will make the object the first object drawn on the page (back layer)

Send back one will move the object back a layer

Bring forward one will move the object forward a layer

Bring to front will make the object the last object drawn on the page (top layer)



The second method is to use the **reorder items...** option in the **Page** menu. This brings up a window as shown below. The object stacking order is shown. Clicking on an entry highlights that entry with a green selection box.

You can use the **Move up** and **Move down** options to change the stacking order of the selected item. Once the objects are in the order you want **OK** will update the page.

Cancel will abort the operation without making any changes.

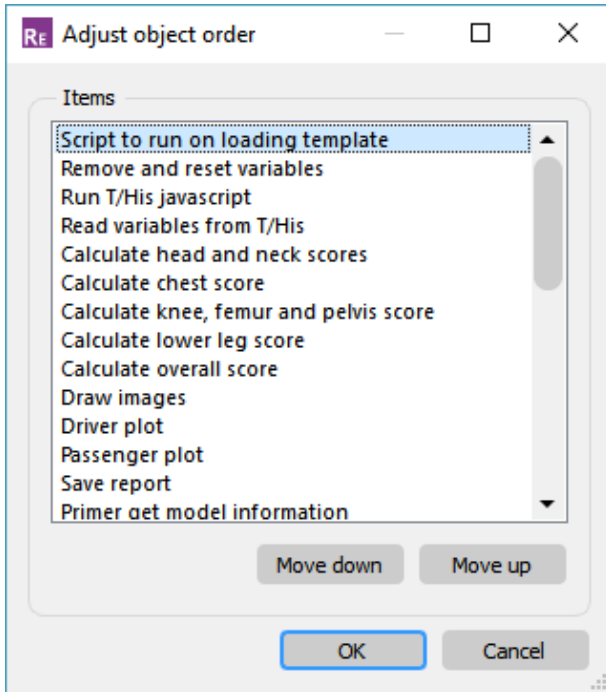
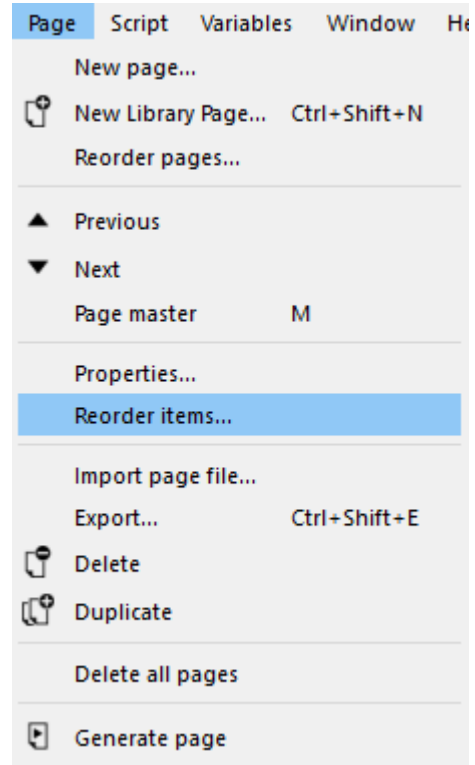



8.7. Locking Items

Locking items

It may be useful to 'lock' objects on the page so that they cannot be moved by dragging. The **Locked** option in the context menu (available by right clicking on a selected item) allows you to do this.

To lock an object first select it and then click on the **Locked** option. If an object is locked it will be shown with a tick symbol. It can be unlocked by clicking on **Locked** again.

Multiple objects can be locked or unlocked at the same time. Toggling the **Locked** option will change the locked property of all of the selected items.

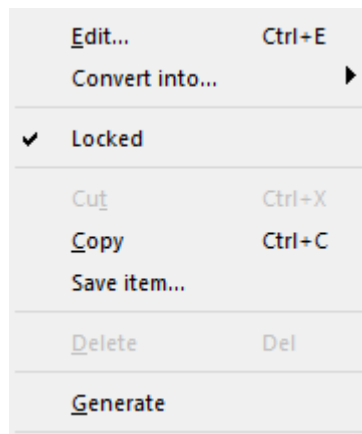

Once an item has been locked it cannot be dragged on the page. It can still be moved by using the arrow keys and the size and/or position can be altered in the edit panel.

You can see which items are locked in design view. A locked item will be drawn with a small padlock symbol.

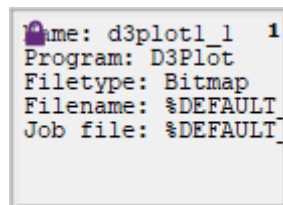



9. Advanced Objects

Advanced objects

This section covers the more advanced items you can use in your REPORTER templates, including:

- [D3PLOT](#), [T/HIS](#) and [PRIMER](#) items. Note that from version 17.0 onwards, REPORTER has been fully integrated with D3PLOT and T/HIS to give you a more seamless reporting workflow. See [REPORTER Integration](#) for details.
- [Placeholder](#) items
- [File](#) and [Library](#) items
- [Tables](#) and [Autotables](#)
- [Programs](#) and [Scripts](#)
- [Note](#) items

9.1. D3PLOT Objects

D3PLOT objects



D3PLOT items allow you to include output from D3PLOT in your template.

There are two different ways of using D3PLOT items. The first (and by far the easiest) is to use the [Capture...](#) button to create the object. The second is to use an existing [D3PLOT command file](#) to create the output from D3PLOT .

If the Image output type is chosen, the [Cropping...](#) button can be used to crop away parts of the image from the top, bottom, left and right before showing it. See [Image Cropping](#) for more details.

The [Justify](#) buttons in the [Image properties](#) section allow you to change the justification of the image in the box on the page. REPORTER will not change the aspect ratio of the image. By default the image will be placed centrally in the box and enlarged as much as possible to still fit in the box. The [Justify](#) buttons can be used to alter the justification in the box if necessary.

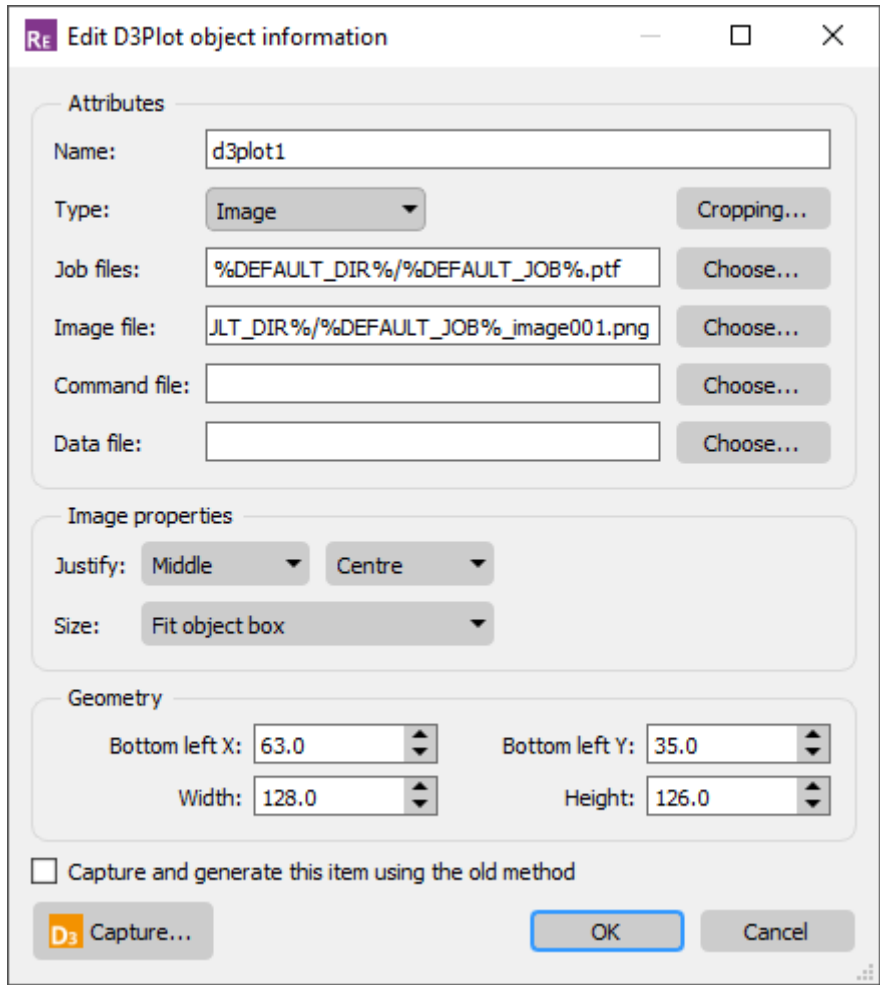

There are four different options for the type of output generated from D3PLOT .

- **Image** indicates that the output is a static file.
- **GIF** indicates that the output is an animated GIF.
- **Movie** indicates that the output is an MP4 movie.
- **Blank** indicates that the D3PLOT object will not create any output on the page

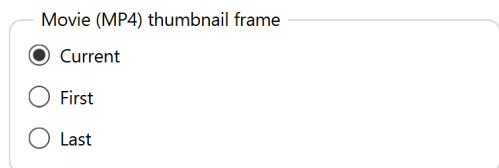
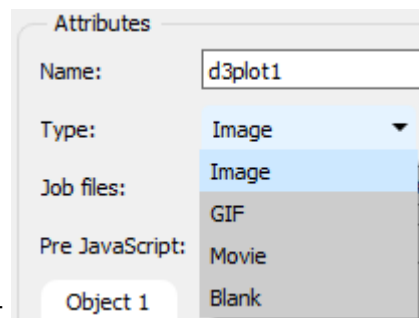

Playback of animated D3PLOT Items of the **GIF** and **Movie** types can be controlled in the same manner as [animated Image Items](#) .



The thumbnails of the **Movie** (MP4) items written out to PPTX and PDF files can be controlled using **Movie (MP4) thumbnail frame** preference found under Preferences->Apps.

By default, this preference is set to **Current**, meaning the thumbnail will reflect the frame where the Movie item is paused. You can also change this setting to **First** or **Last** to control which frame is used as the thumbnail.

From version 13.0 of REPORTER it is possible to specify the size or aspect ratio of the image created from D3PLOT . This can be changed in the **Image properties** section. If you want to specify a particular aspect ratio or graphics size you can change this. The available options for **Size** are:

- Free size
- Fit object box
- 4:3 aspect ratio
- 16:9 aspect ratio
- 16:10 aspect ratio
- Custom aspect ratio
- Fixed size

The default option from version 17.0 onwards is **Fit object box** . With this option, D3PLOT will capture an image using a graphics window with the same aspect ratio as the object's dimensions in REPORTER .

In previous versions of REPORTER , the default option was **Free size** . With this option, the size of the graphics window is calculated by D3PLOT . The actual size will depend on what resolution the monitor is and what scale factors you have chosen for the user interface. This can cause problems if the template is created on one type of display (e.g. a 16:9 monitor) but played back on a different ratio monitor (e.g. a 4:3 ratio monitor) as the image size can change and so the output from REPORTER can look different. To make output consistent you can use the other options:

Fit object box will make D3PLOT create a graphics window that has the same aspect ratio as the object box dragged in REPORTER .

4:3 aspect ratio , **16:9 aspect ratio** and **16:10 aspect ratio** will make D3PLOT create a window with the specified aspect ratio.

Custom aspect ratio or **Fixed size** allow you specify a custom width and height. **Fixed size** will make D3PLOT create an image with the specified width and height. **Custom aspect ratio** will make D3PLOT create the largest image it can with the aspect ratio width:height.



9.1.1. Using Capture to Create a D3PLOT Object

Using Capture to create a D3PLOT object

The easiest way to create a D3PLOT object is to use the **Capture...** command. If you press the button, REPORTER starts D3PLOT for you if it is not already linked. You can now open the model(s) and do whatever operations you want inside D3PLOT such as rotating, zooming, blanking, selecting the state, setting colours, and so on. Variables can be defined interactively by pressing the **Show Variables** button in the REPORTER panel in D3PLOT .

Once you are happy with the image and variables you have in D3PLOT , press the **Capture** button on the top bar of the target window. D3PLOT will automatically create a settings file, a properties file, a command file and a variables file for the current image and add them to the D3PLOT item in REPORTER . These are embedded in the template so you do not have to worry about packaging them with your template file.

The **Capture** tool can also be used to produce animated content in MP4 and GIF formats, as well as 3D GLB models. These can be accessed by right-clicking on the **Capture** button and selecting the **Movie**, **GIF**, or **GLB** options respectively.

All settings used when capturing a **GIF** or **Movie** (e.g. frame rate, image quality, state selection) will be taken from the **Movies** tab of the **Images / Media Export** panel in D3PLOT .

Some settings used when capturing **GLB** content (e.g. frame rate, state selection) will be taken from the **D3PLOT Viewer** tab of the **Images / Media Export** panel in D3PLOT. However, the File Format (compression) and Output (animation) settings are handled directly by the **Capture** dropdown menu.

All four of the **GLB** options produce content that is viewable by D3PLOT Viewer, but **GLB (Current frame, Uncompressed) is the only option that is currently suitable for export to PowerPoint**. Microsoft PowerPoint supports this uncompressed format in PowerPoint for Microsoft 365 or in PowerPoint 2019 or later.

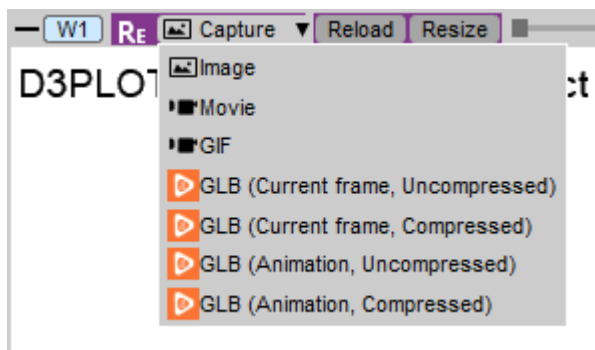



From version 17.0 onwards, D3PLOT is linked to REPORTER so you can continue working with both programs open. In earlier versions (and if capturing items using the old method), you would need to return to REPORTER using the D3PLOT **File** menu and select => (which replaces the normal Exit command).

See [REPORTER Integration](#) for more tips about how to make the most of D3PLOT linked to REPORTER .

Attributes

Name: d3plot1

Type: Image [Cropping...]

Job files: %DEFAULT_DIR%/... [Choose...]

Pre JavaScript: <no script defined> [Edit...]

Object 1

Image file: %DEFAULT_DIR%/... [Choose...]

Command file: (automatically generated) [Edit...]

Data file: [Choose...]

JavaScript: <no script defined> [Edit...]

Image properties

Justify: Middle [Centre]

Size: Custom aspect ratio [Width: 3088] [Height: 1892]

Geometry

Bottom left X: 147.0 [Bottom left Y: 69.0]

Width: 55.0 [Height: 65.0]

Capture options

Replay JavaScripts when reloading capture in D3PLOT

Capture and generate this item using the old method

Blank model before reading properties file

Ignore elements in properties file

[D3] Reload capture... [OK] [Cancel]

Once a D3PLOT item has been captured, the **Job files** textbox reflects the models used in the capture. See [Working with Variables](#) for more information about how to make your D3PLOT item work for different models.



REPORTER automatically assigns an **Image file** name for you. If required you can change this to whatever name you require. Note that the format of the file is taken from the extension you provide. By default D3PLOT will return a PNG (for **Image** type), a **GIF**, an MP4 (for **Movie** type), or a **GLB** to REPORTER. For the **Image** type, other valid file extensions include *.jpg*, *.bmp*, *.gif*, and *.tif*. If you wanted to create an image matching one of these formats, change the extension in the textbox accordingly.

The Command file is greyed out as it has been automatically created by D3PLOT and does not need any editing. However, if you wanted to add some extra dialogue commands to be done in D3PLOT when generating the object you can use the **Edit...** button next to the **Command File** textbox to add/edit them.

You can also specify two JavaScript scripts to run when generating the D3PLOT object; a **Pre JavaScript** and a 'normal' **JavaScript**. To explain why there are two possible JavaScript scripts we need to consider the order that D3PLOT uses when creating the image. It is:

1. Read the ptf files
2. Run Pre JavaScript (if defined)
3. Read properties and settings files stored in REPORTER template
4. Run any extra Command file dialogue commands from REPORTER (if defined).
5. Run the 'normal' JavaScript (if defined)
6. Read external [data file](#) (if defined)

For virtually all cases the 'normal' JavaScript file in step 5 will do what you want. However if you use a JavaScript to create a user defined data component then this must be run before the properties and settings files are read (as that is where the data component for the plot is stored). In this case a **Pre JavaScript** has to be used.

If you want to change your capture or its associated variables you can press **Reload capture...** again at any time. D3PLOT will start again and restore the current attributes you have set. You can make any changes that you want before pressing the **Capture** button as before. The old settings file, properties files and variables file will be overwritten.

As of REPORTER 21.0, D3PLOT items have two extra options: pre-blank the D3PLOT model before reading the properties file, and ignore elements when reading the properties file. These options are particularly useful when you want consistent captures when you reload the capture or generate the item on a model with parts/elements that have been added or re-numbered. These options are originally preferences, and still are (see [App items](#)), but are now also per-item options. These options will be saved to the report or template which will ensure similar captures when the report or template is shared with users that do not have the corresponding preferences set. If you open a version 21 and above template or report, the preferences are ignored and the per-item options are honoured. If you open a version 20.1 and below template or report, the preferences are only honoured as long as none of the two options are selected in the D3PLOT dialog.



Here is an example of using these options:

DOPLOT_161



Original capture.

DOPLOT_161



Capture **without** the pre-blanking option when the item is reloaded/generated with the model with **additional** car door parts.

DOPLOT_161



Capture **with** the pre-blanking option when the item is reloaded/generated with the model with **additional** car door parts. Similar capture obtained to the original capture.



9.1.2. Creating Multiple Images from a Single D3PLOT Session

Creating multiple images from a single D3PLOT session

From D3PLOT 17.0 onwards, you can quickly capture and generate multiple images from a single D3PLOT session as separate D3PLOT items. The old method of capturing D3PLOT items with multiple child images is no longer needed because its main purpose was to avoid having to launch D3PLOT multiple times to generate a single template. Now that D3PLOT and REPORTER are linked, all of the items in a template can be generated from a single session. The old method described below is only preserved to help keep old templates working.

You are not limited to making a single image in D3PLOT . Using the **Objects** floating menu you can capture as many images as you want in a single D3PLOT session. A tab will be created in the **Edit D3PLOT object** window for each image you capture. For example as well as making a von Mises stress image we may also want to make an image showing plastic strain.

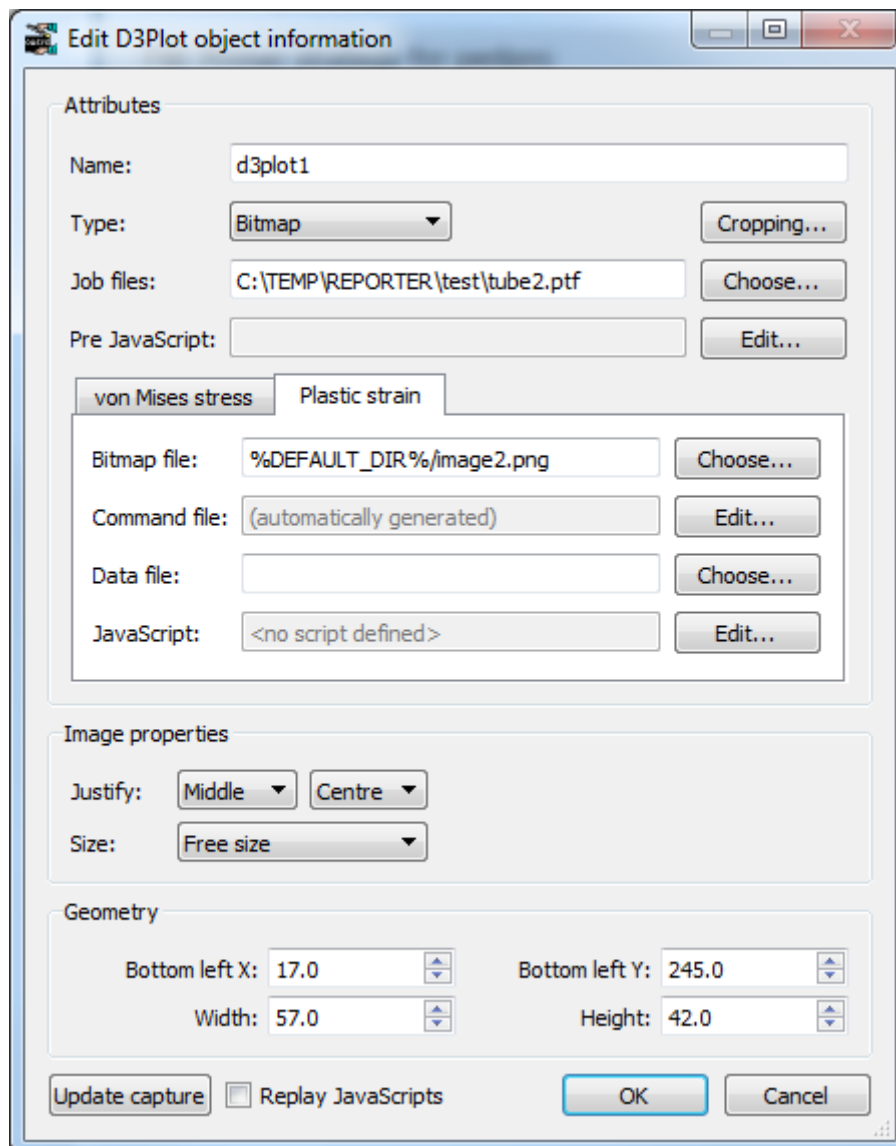



Each image has its own properties and settings file and optionally extra command files and/or a JavaScript. In REPORTER an **Image file** is created for the second and subsequent images and these are linked to the 'parent' D3PLOT object.

```
Name: d3plot1 1
Program: D3Plot
Filetype: Bitmap
Filename: "%DEFAULT DIR%/imag
Job file: C:\TEMP\REPORTER\te
```

```
Name: file2 2
Parent: d3plot1
File: Plastic strain
Filetype: image
```

To help show which objects are linked together they are coloured differently to normal objects. The first group will be red, the second green, the third blue...

If you modify the 'parent' D3PLOT object the 'child' Image file objects will be added/updated/deleted as required.



9.1.3. Using Datafiles to Create 'Blob' Plots

Using datafiles to create 'blob' plots

If a **Data file** is given then that is passed to D3PLOT to create an external data plot or 'blob' plot. An example plot is shown below. In a data plot D3PLOT superimposes data values on the 3 dimensional shape. For example, below this is used to show HIC values for Euro-NCAP analyses at various positions on the bonnet.

The easiest way of creating a data file is to use the standard library program in REPORTER . See [variables](#) and the D3PLOT manual for more details.

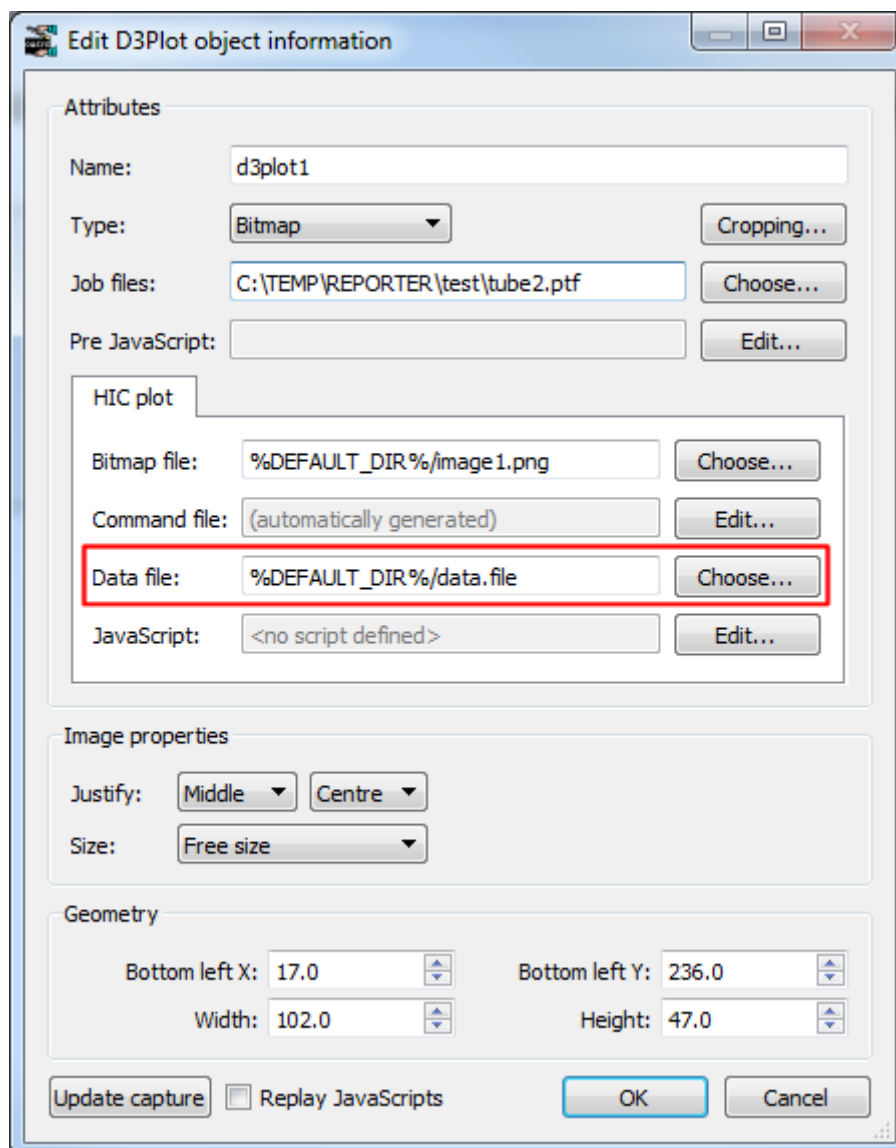

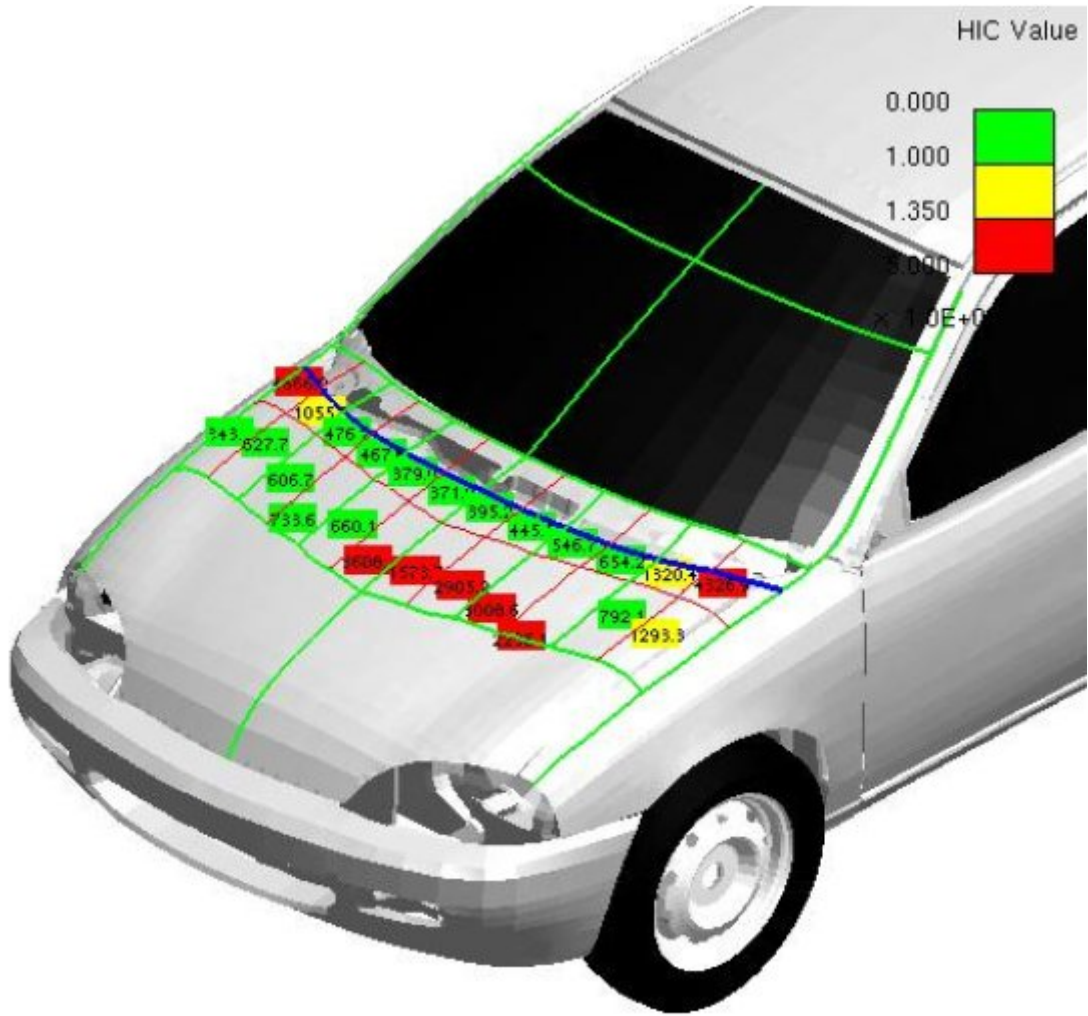



9.1.4. Using a Command File to Create a D3PLOT Object

Using a command file to create a D3PLOT object

A really old (and not-at-all-recommended) method to create a D3PLOT object is to create a command file yourself in D3PLOT (which creates the image). In this case the **Image file** must correspond to the name of the image you create in the command file. Give the name of the **Command file** and the **Job file**.

This method is not recommended and is present only to keep old templates working. Use the [Capture](#) method instead.

Attributes

Name: d3plot10

Type: Image Cropping...

Job files: %DEFAULT_DIR%/test.ptf Choose...

Image file: %DEFAULT_DIR%/image.png Choose...

Command file: %DEFAULT_DIR%/test.tcf Choose...

Data file: Choose...

Image properties

Justify: Middle Centre

Size: Fit object box

Geometry

Bottom left X: 19.0 Bottom left Y: 131.0

Width: 89.0 Height: 70.0

Capture and generate this item using the old method

Capture... OK Cancel



9.1.5. Editing D3PLOT Objects

Editing D3PLOT objects

The position and size of D3PLOT objects can be edited in exactly the same way as the simple shape objects. See [Editing shapes, images and text objects](#) for more details.

If you have created the D3PLOT object using [Capture...](#) then the text on the button will change to **Reload capture...** You can modify/update the existing captures if required. See [Using capture to create a D3PLOT object](#) for more details.



9.2. T/HIS Objects

T/HIS objects



T/HIS objects allow you to include output from T/HIS in your template.

There are three different ways of using T/HIS objects. The first (and by far the easiest) is to use the [Capture...](#) button to create a FAST-TCF script for the object that T/HIS will run.

The second is to write your own FAST-TCF script.

The third is to use an existing [T/HIS command file](#) to create the output from T/HIS .

If the Bitmap output type is chosen, the [Cropping...](#) button can be used to crop away parts of the image from the top, bottom, left and right before showing it. See [Image cropping](#) for more details.

The [Justify](#) buttons in the [Image properties](#) section allow you to change the justification of the image in the box on the page. REPORTER will not change the aspect ratio of the image. By default the image will be placed centrally in the box and enlarged as much as possible to still fit in the box. The [Justify](#) buttons can be used to alter the justification in the box if necessary.

Attributes

Name:

Type:

Output: [Cropping...](#)

Job file: [Choose...](#)

Bitmap file: [Choose...](#)

FAST-TCF script

[Load...](#) [Save...](#)

Image properties

Justify:

Size:

Geometry

Bottom left X: Bottom left Y:

Width: Height:

Capture and generate this item using the old method

[T/H Capture...](#) [OK](#) [Cancel](#)



There are three different options for the type of output generated from T/HIS .

- **Bitmap** indicates that the output is an image file.
- **Blank** indicates that the T/HIS object will not create any output on the page
- **Text** indicates that the output is text. This is only valid for the **FAST-TCF script** type. This option would be used if you wanted the output from a FAST-TCF table or HIC command etc.

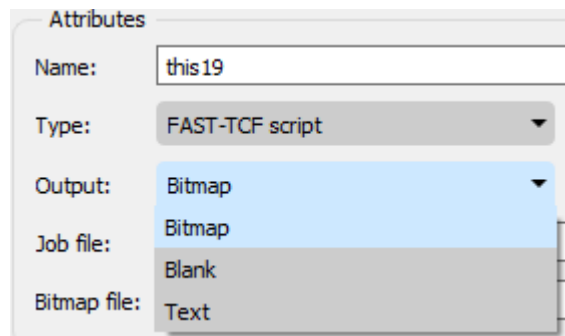

From version 13.0 of REPORTER it is possible to specify the size or aspect ratio of the image created from T/HIS . This can be changed in the **Image properties** section. If you want to specify a particular aspect ratio or graphics size you can change this. The available options for **Size** are:

- Free size
- Fit object box
- 4:3 aspect ratio
- 16:9 aspect ratio
- 16:10 aspect ratio
- Custom aspect ratio
- Fixed size

The default option from version 17.0 onwards is **Fit object box** . With this option, T/HIS will capture an image using a graphics window with the same aspect ratio as the object's dimensions in REPORTER .

In previous versions of REPORTER , the default option was **Free size** . With this option, the size of the graphics window is calculated by T/HIS . The actual size will depend on what resolution the monitor is and what scale factors you have chosen for the user interface. This can cause problems if the template is created on one type of display (e.g. a 16:9 monitor) but played back on a different ratio monitor (e.g. a 4:3 ratio monitor) as the image size can change and so the output from REPORTER can look different. To make output consistent you can use the other options:

Fit object box will make T/HIS create a graphics window that has the same aspect ratio as the object box dragged in REPORTER .

4:3 aspect ratio , **16:9 aspect ratio** and **16:10 aspect ratio** will make T/HIS create a window with the specified aspect ratio.

Custom aspect ratio or **Fixed size** allow you specify a custom width and height. **Fixed size** will make T/HIS create an image with the specified width and height. **Custom aspect ratio** will make T/HIS create the largest image it can with the aspect ratio width:height.



9.2.1. Using Capture to Create a T/HIS Object

Using Capture to create a T/HIS object

The easiest way to create a T/HIS object is to use the **Capture...** command.

First make sure that the **Type** is set to **FAST-TCF script**.

If you press the **Capture...** button REPORTER starts T/HIS for you if it is not already linked. You can now open the model(s) and do whatever operations you want inside T/HIS to get the cruves that you want on the screen. Once you are happy with the graph you have in T/HIS, press the **Capture** button on the top bar of the target window. T/HIS will automatically create a FAST-TCF script for the current graph and return it to REPORTER. This is embedded in the template so you do not have to worry about packaging it with your template file.

From version 17.0 onwards, T/HIS is linked to REPORTER so you can continue working with both programs open. In earlier versions (and if capturing items using the old method), you would need to return to REPORTER using the T/HIS **File** menu and select **Return to** (which replaces the normal Exit command).

See [REPORTER Integration](#) for more tips about how to make the most of T/HIS linked to REPORTER.

Once a T/HIS item has been captured, the **Job file** textbox reflects the models used in the capture. See [Working with Variables](#) for more information about how to make your T/HIS item work for different models.

If you want to change the script you can press **Reload capture...** again at any time. T/HIS will start again and replay the FAST-TCF script. You can make any changes that you want before pressing the **Capture** button as before. The old FAST-TCF script will be overwritten.

RE Edit T/HIS object information

Attributes

Name:

Type:

Output:

Job file:

Bitmap file:

FAST-TCF script

```
#
# Built in variables:
# =====
# $ftcf_script: Name of the FAST-TCF that is being run.
# $ftcf_script_dir: Name of the FAST-TCF directory.
# $ftcf_dir: Name of the current working directory.
# $ftcf_path: Full pathname of the current working directory.
# $ftcf_startin_dir: Directory T/HIS was started from.
#
# $run_name: Basename of the key file for the first model.
# $run_dir: Full pathname of output file directory.
# $run_title: Title of the analysis found in the output files.
#
# If a script refers to multiple models then, $run_nameN,
```

Image properties

Justify:

Size:

Geometry

Bottom left X: Bottom left Y:

Width: Height:

Capture and generate this item using the old method



9.2.2. Using Your Own FAST-TCF Script to Create a T/HIS Object

Using your own FAST-TCF script to create a T/HIS object

If you want to make your own FAST-TCF script in a T/HIS object then fill in the **Image file** and **Job file** yourself. You can load an existing FAST-TCF script by using the **Load...** button or type in the script. In this case the **Image file** must correspond to the name of the image you create in the script.



9.2.3. Using a Command File to Create a T/HIS Object

Using a command file to create a T/HIS object

The alternative method to create a T/HIS object is to create a command file yourself in T/HIS (which creates the image).

Make sure that **Type** is set to **T/HIS command file**.

In this case the **Image file** must correspond to the name of the image you create in the command file. Give the name of the **Command file** and the **Job file** .

Edit T/HIS object information

Attributes

Name:

Type:

Output:

Job file:

Bitmap file:

Command file:

Image properties

Justify:

Size:

Geometry

Bottom left X: Bottom left Y:

Width: Height:

Capture and generate this item using the old method



9.2.4. Editing T/HIS Objects

Editing T/HIS objects

T/HIS objects can be edited in exactly the same way as the simple shape objects. See [Editing shapes, image and text objects](#) for more details.

If you have created the object using the [Capture...](#) then the text on the button will change to [Reload capture...](#) You can modify/update the existing capture if required. See [Using capture to create a T/HIS object](#) for more details.

9.3. PRIMER Objects

PRIMER objects



PRIMER objects allow you to include output from PRIMER in your template. To create one select the PRIMER tool from the [Tools toolbar](#) and click and drag a rectangle on the page. The [Edit PRIMER object information window](#) will then be shown.

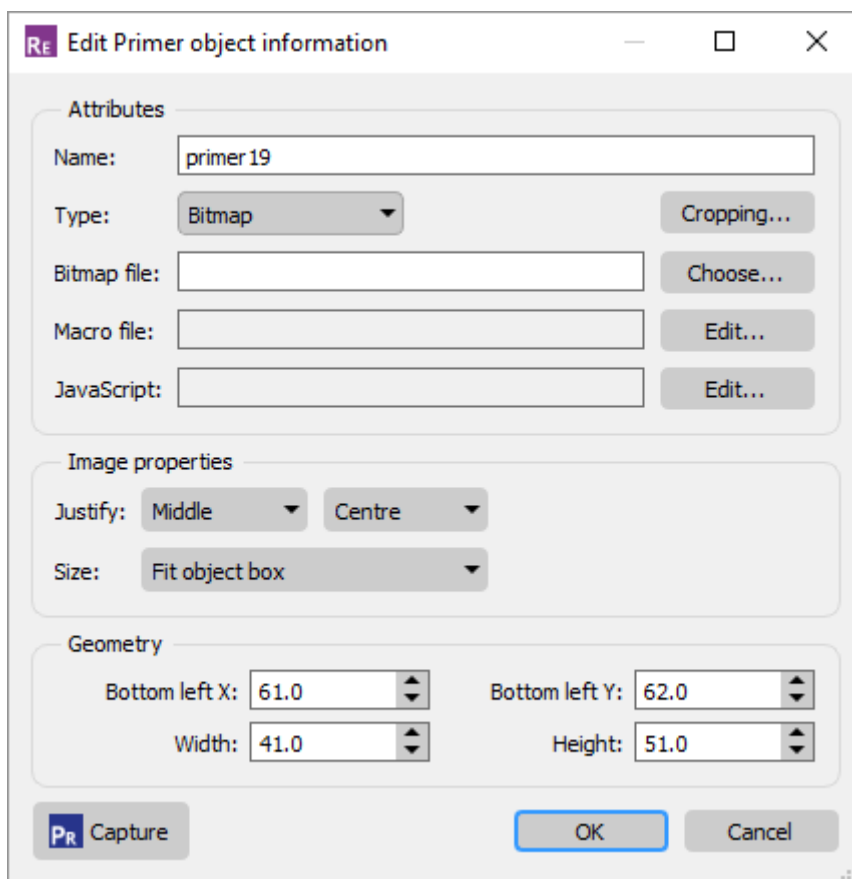

If you want to create an image using PRIMER to put in the report (e.g. an image showing yield stress or element timestep) select **Bitmap** for the **Type** . In this case the **Cropping...** button can be used to crop away parts of the image from the top, bottom, left and right before showing it (see [Image cropping](#) for more details).

The **Image properties** section allows you to change the justification of the image in the box on the page. REPORTER will not change the aspect ratio of the image. By default the image will be placed centrally in the box and enlarged as much as possible to still fit in the box. The **Justify** buttons can be used to alter the justification in the box if necessary.

Alternatively if you do not want any output but just want to run PRIMER to create some other sort of output or run a JavaScript set the **Type** to **Blank** .



9.3.1. Using Capture to Create a PRIMER Object

Using Capture to create a PRIMER object

From version 13.0 of REPORTER it is possible to specify the size or aspect ratio of the image created from PRIMER . This can be changed in the **Image properties** section. If you want to specify a particular aspect ratio or graphics size you can change this. The available options for **Size** are:

- Free size
- Fit object box
- 4:3 aspect ratio
- 16:9 aspect ratio
- 16:10 aspect ratio
- Custom aspect ratio
- Fixed size

The default option from version 17.0 onwards is **Fit object box** . With this option, PRIMER will capture an image using a graphics window with the same aspect ratio as the object's dimensions in REPORTER .

In previous versions of REPORTER , the default option was **Free size** . With this option, the size of the graphics window is calculated by PRIMER . The actual size will depend on what resolution the monitor is and what scale factors you have chosen for the user interface. This can cause problems if the template is created on one type of display (e.g. a 16:9 monitor) but played back on a different ratio monitor (e.g. a 4:3 ratio monitor) as the image size can change and so the output from REPORTER can look different. To make output consistent you can use the other options:

Fit object box will make PRIMER create a graphics window that has the same aspect ratio as the object box dragged in REPORTER .

4:3 aspect ratio , **16:9 aspect ratio** and **16:10 aspect ratio** will make PRIMER create a window with the specified aspect ratio.

Custom aspect ratio or **Fixed size** allow you specify a custom width and height. **Fixed size** will make PRIMER create an image with the specified width and height. **Custom aspect ratio** will make PRIMER create the largest image it can with the aspect ratio width:height.

If you want to specify an image size it should be specified before the capture is done in PRIMER .

To start PRIMER press the **Capture** button. PRIMER will then automatically record a macro containing all of the commands that you do. When you have finished do **File** and **=>** to return to REPORTER .

REPORTER will then prompt you to replace any filenames in the macro with variables. You can choose which variables you would like to replace. Alternatively you can replace



any variables yourself manually later on (see below).

The **Edit PRIMER object information window** will then be updated as shown below.

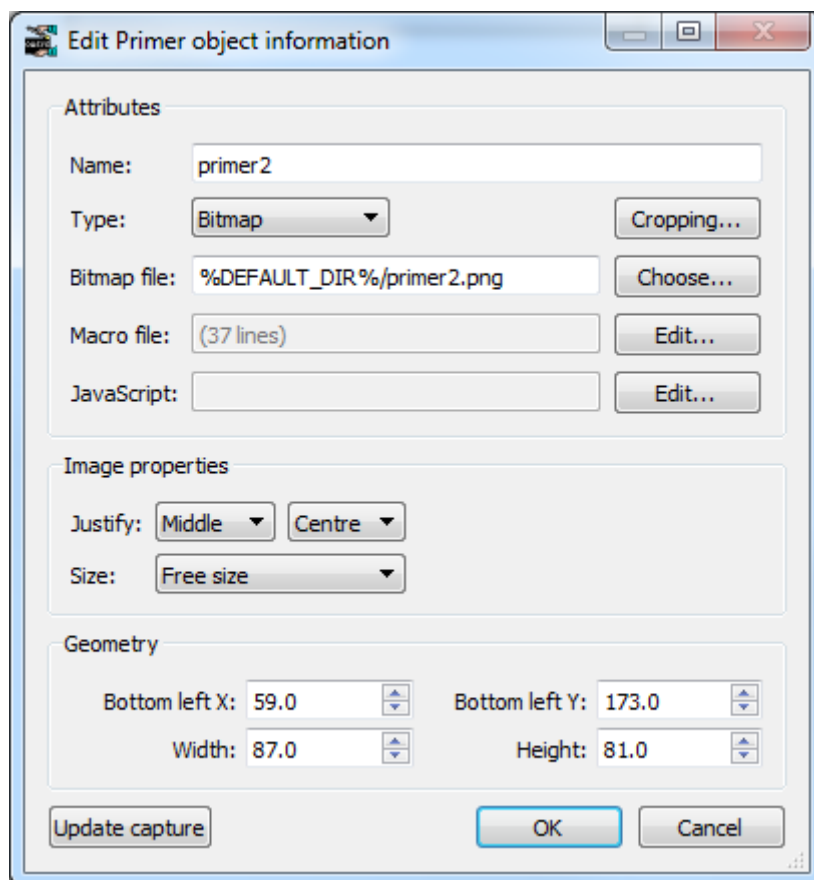

REPORTER will automatically give a name for the bitmap file but you can change it to whatever you want. If required you can edit the macro by using the **Edit...** button next to the **Macro file** textbox (which in the above image shows that it contains 25 lines). This is useful to replace any filenames with variables if required (right click with the mouse or press Ctrl+I in the macro to insert variables). The macro will be saved in the REPORTER template.

As well as using a macro a JavaScript can also be specified to run in PRIMER . The **Edit...** button next to the **JavaScript** textbox can be used to load and edit a JavaScript. The JavaScript will be saved in the REPORTER template.

If a macro contains picking, dragging or dynamic viewing commands then PRIMER needs to maintain the aspect ratio of the graphics window so that they can be replayed correctly. If it did not do this then the pick command would pick at a different location and it may not work correctly.

When a macro is recorded REPORTER scans the macro for any picking, dragging or dynamic viewing commands. If the macro does not contain any then the image size can be changed after capturing if required.

For example in the image above a macro has been recorded but as it does not contain any picking, dragging or dynamic viewing commands the **Size** can be changed from **Free size** if required.



If the macro does contain picking, dragging or dynamic viewing commands then REPORTER will change the image size to a fixed size and not allow it to be changed, to ensure that the macro will replay correctly.

For example in the image below a macro has been recorded but and it as does contain picking, dragging or dynamic viewing commands the **Size** has been changed to **Fixed size** and cannot be changed.

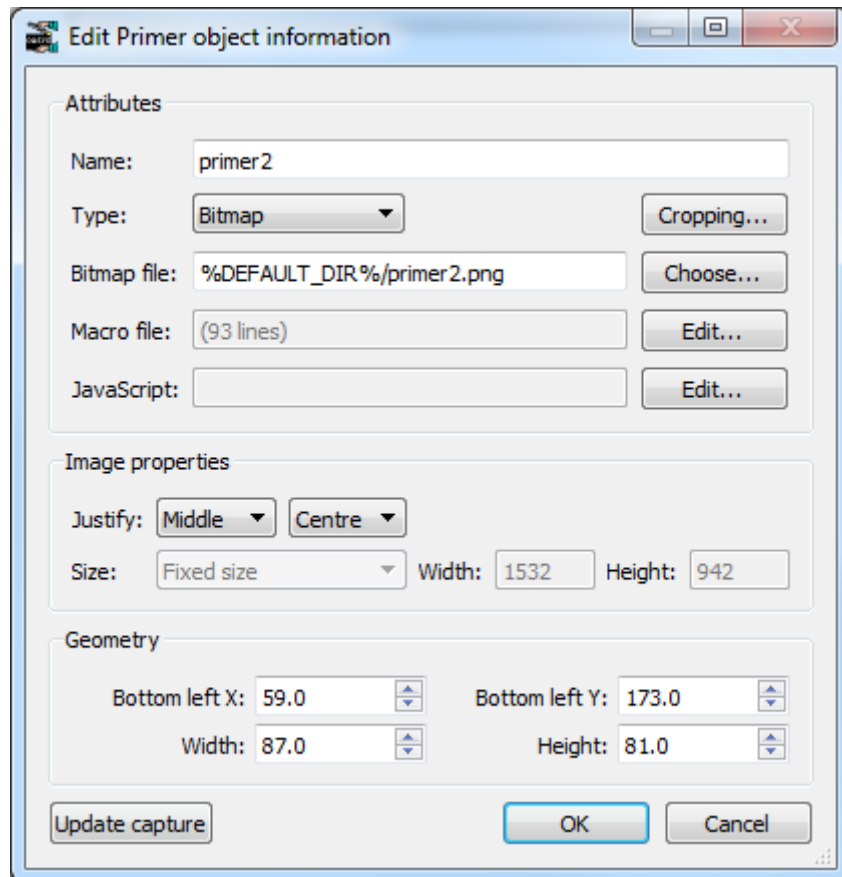



9.3.2. Editing PRIMER Objects

Editing PRIMER objects

PRIMER objects can be edited in exactly the same way as the simple shape objects. See [Editing shapes, images and text objects](#) for more details.

If you want to modify an existing capture you can use **Update capture** . PRIMER will restart and replay the macro you have recorded. Any new commands that you do will then get appended to the macro.



9.4. Program Objects

9.4.1. Text Output From a Program

Text output from a program

Enter program information

Attributes

Name:

Program:

Arguments:

Text properties

Style:

Justify:

Font:

Size:

Geometry

Bottom left X:

Bottom left Y:

Width:

Height:



This option allow you to specify a program from which the text that would normally outputted to the standard output will be inserted into the report by REPORTER when the report is finally generated. The program can be written in anything you want: C, Fortran etc,a scripting language such as Perl or Python, a shell script on unix, a batch file on windows etc. All that matters is that output which would normally be directed to



stdout is captured by REPORTER . For more details on writing programs for REPORTER please see [Appendix D](#).

The filename of the program/script is entered in the **Program:** text box or clicking on the **Choose...** button will bring up a **File** window from which to select the program/script. You can also enter variables by right clicking in the text box which will allow you to bring up a **Insert variables** window from which to select a variable. The various text parameters such as font and size can also be set.

The text parameters such as font, justification, size etc can be set for the text that will be captured from the program.

If the program needs arguments then any number can be added by using the **Add** button.

The **Conditions...** button (see [Conditional Formatting](#)) enables the user to apply conditional formatting to the text from the program.

The **OK** button will exit this window and add the new program to the template. The **Cancel** button will exit this window without adding anything to the report



9.4.2. Editing Program Objects

Editing program objects

Program objects can be edited in exactly the same way as the simple shape objects. See [Editing shapes, image and text objects](#) for more details.

9.5. File Objects

9.5.1. Text Files

Text files

To insert text from a file, select the **File Text** from the **Insert** menu.

The **Choose...** button allows the user to select the file by browsing the computer. The positioning and style of the text can be changed.

The **OK** button will exit this screen and create the object/save the changes made.

The **Cancel** button will exit this screen without creating the object/saving the changes.

The text parameters such as font, justification, size etc can be set for the text that will be read from the file.

The text, background and fill colour and the border line style can be set using the [style toolbar](#). See [Setting line style, thickness, colour and fill colour](#) for more details.

The margins for the textbox can be changed by using the [Margins...](#) button.

The [Conditions...](#) button (see [Conditional formatting](#)) enables the user to apply conditional formatting to the text.

By default text is not wrapped so long lines will be clipped to the width of the object. If you want text to be wrapped onto multiple lines use the **Wrap text** checkbox.

RE Enter file and text information

Attributes

Name:

File:

Text properties

Style:

Justify:

Font: Size:

Wrap text

Geometry

Bottom left X: Bottom left Y:

Width: Height:





9.5.2. Image Files

Image files

To insert an image from a file, select the **File Image** from the **Insert** menu or use the Image file tool from the Tools toolbar.

The **Choose...** button allows the user to select the file by browsing the computer.

The **Cropping...** button can be used to crop away parts of the image from the top, bottom, left and right before showing it. See [Image cropping](#) for more details.

The **Image properties** section allows you to change the justification of the image in the box on the page. REPORTER will not change the aspect ratio of the image. By default the image will be placed centrally in the box and enlarged as much as possible to still fit in the box. The **Justify** buttons can be used to alter the justification in the box if necessary.

The positioning of the image on the page can be changed by using the **Geometry** section.

The **OK** button will exit this screen and create the object/save the changes made.

The **Cancel** button will exit this screen without creating the object/saving the changes.

Enter image file information

Attributes

Name:

File: **Choose...**

Cropping...

Image properties

Justify: **Middle** **Centre**

Geometry

Bottom left X: Bottom left Y:

Width: Height:

OK **Cancel**



Animated Image files

Similarly to [Image](#) Items, starting with version 18.0, Image File Items also support GIF animations and MP4 movies.



9.6. Library Objects

9.6.1. Library Images

Library images



This option allows the user to view and select an image from the selection held in the image library. The resolution and positioning of the image can also be set. The **OK** button will exit this windows and add the new object to the template. The **Cancel** button will exit this window without adding anything to the report.

See [Standard library images](#) - to insert library images.

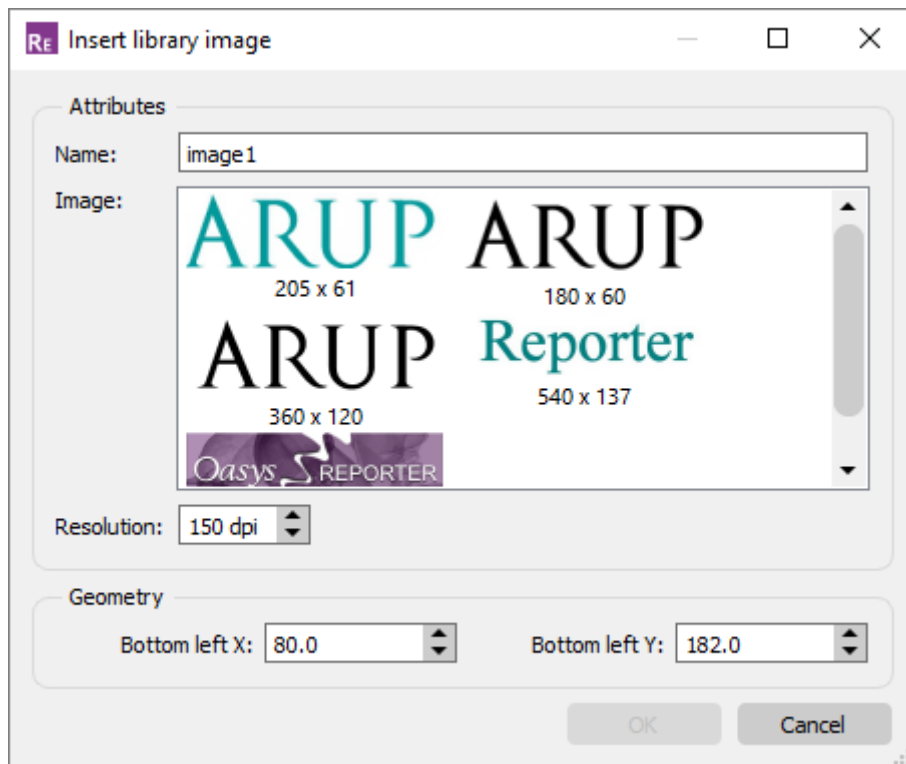

9.6.2. Library Program/Script

Library program/script





This option allows you to specify a program/script from the library, the output of which will be inserted into the report by REPORTER when the report is finally generated. (See the [Standard library programs](#) for more details about using the library)

Once you have selected this option you need to click and drag to create an area in the report where the output is to appear. Then the relevant **Insert** window will be brought up.

From this window you can select the program/script you want from the program list by clicking on it with the mouse. Depending on the program/script a number of argument boxes may appear into which you need to specify any arguments required by the script. By right clicking or pressing **Ctrl+I** in these you can bring up a **Insert variables** window from which to select a variable to use for the argument.

The output from the program/script can be set to a variable using the **Set to variable** input box or **Select** button. Additionally you can specify that the output from the program is not shown on the page by using the **Do not show any output on page** option. This could be useful if you want to run the program to get the output as a variable but use it later in the template (for example in a table) rather than having any output here.

The font properties can be set using the **Text properties** section. The text colour will be set to the current [text colour](#) setting.

The **Conditions...** button (see [Conditional formatting](#)) enables the user to apply conditional formatting to the text.

The **OK** button will exit this windows and add the new object to the template.

The **Cancel** button will exit this window without adding anything to the report.

RE Choose Library Program

Attributes

Name:

Program:

- > Errors
- > Keyword file
- > NCAP
- ▼ OTF file
 - Analysis date
 - Analysis precision
 - Analysis title
 - Check on the quality of the run
 - CPU time for analysis**
 - Hostname analysis run on

Arguments:

	Description	Value
1	OTF file name	%DEFAULT_DIR%/%%DEFAULT_JOB%.otf

Output

Set to variable:

Do not show any output on page

Text properties

Style:

Font:

Justify:

Size:

Geometry

Bottom left X: Bottom left Y:

Width: Height:

9.6.3. Editing Library Objects

Editing library objects

Library objects can be edited in exactly the same way as the simple shape objects. See [Editing shapes, image and text objects](#) for more details.



9.7. Table Objects

Table objects



A table allows you to easily line things up on a page in REPORTER . To create a table drag the area on the page that you want to be a table. The following menu is then mapped.

Enter Table information

Attributes

Name:

Rows: Columns:

Fix overall table size while adding/deleting/resizing rows and columns

Cells:

	Column 1	Column 2
Row 1		
Row 2		

Cell properties

Text

Width: Height:

Program arguments

Geometry

Bottom left X: Bottom left Y:

Width: Height:

When generating save to CSV file:

When generating save to XLSX file:



9.7.1. Changing the Number of Rows or Columns in the Table

Changing the number of rows or columns in the table

By default a table will have 2 rows and 2 columns and initially each cell in the table will be blank. The number of rows and/or columns can be changed using the **Rows** and **Columns** spin boxes in the **Attributes** section. As the values are changed the **Cells** section in the menu will be updated accordingly.

Alternatively a row or column can be added or deleted at any position in the table by right clicking on a cell or header in the **Cells** section and using the Insert or Delete options in the context menu.



9.7.2. Using the 'Fix Overall Table Size...' Checkbox

Using the 'Fix overall table size...' checkbox

By ticking the 'Fix overall table size while adding/deleting/resizing rows and columns' checkbox in the **Attributes** section, the overall table size remains fixed no matter what cell/row/column operations are performed. E.g. if the checkbox is ticked and a row is added to the table using the spinbox, the height of all other rows are reduced (scaling proportionally) to maintain the overall table height. The height of the newly added row is equal to that of the adjacent row.

When the checkbox is unticked, cell/row/column operations are able to change the overall table size. E.g. if the checkbox is unticked and a row is added to the table using the spinbox, the height of all other rows are unchanged. The height of the newly added row is equal to that of the adjacent row and the overall height of the table increases by this amount.

The checkbox is ticked by default when first creating a table (such that the table remains within the bounding box drawn on the page), and unticked by default when editing an existing table.

It is important to note that this checkbox affects operations as they are performed within the edit window, not at the point at which 'OK' is pressed. Ticking or unticking the checkbox should therefore occur prior to any cell/row/column operations to obtain the desired functionality.



9.7.3. Changing the Margins for Cells in the Table

Changing the margins for cells in the table

The margins for the cells in the table can be changed using the margins button in the **Attributes** section.

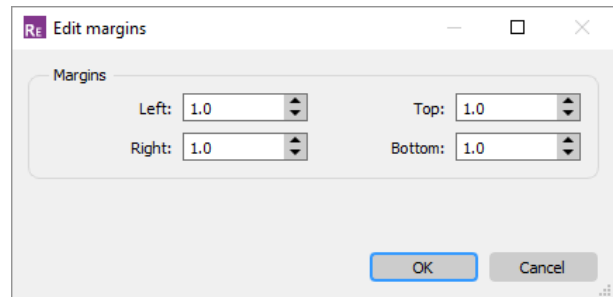



9.7.4. Seeing what is in Each Cell

Seeing what is in each cell

The attributes section of the menu shows a simplified view of the table in a spreadsheet form in the **Cells** section. Cells which have text present in them are shown using the correct font, styling, font colour and size so you can quickly see you have the correct settings.

Attributes

Name:

Rows: Columns:

Fix overall table size while adding/deleting/resizing rows and columns

Cells:

	Column 1	Column 2	Column 3
Row 1	abcdefghi...	abc...	abcdefghijklmnop
Row 2	abcdefghij...	abc...	abcdefghijklm...
Row 3	abcdefghij...	abc...	abcdefghijklmnop



9.7.5. Changing Cells

Changing cells

The screenshot shows a software interface for editing a table. The 'Attributes' section at the top includes a 'Name' field with 'table1', 'Rows' set to 3, and 'Columns' set to 3. There are buttons for 'Reset heights', 'Reset widths', and 'Margins...'. A checkbox for 'Fix overall table size while adding/deleting/resizing rows and columns' is present. Below this is a table preview with three columns and three rows. The first cell of the first row is highlighted in blue. The 'Cell properties' section below the table has a 'Text' dropdown, a 'Font...' button, and buttons for 'Choose...', 'Hyperlink...', and 'Conditions...'. It also features 'Width' and 'Height' spinboxes. At the bottom, there is a 'Program arguments' text area and buttons for 'Add', 'Remove', and 'Edit'.

To change a cell (or cells) click on the cell in the simplified view (or multiple select using Shift and/or Ctrl). The selected cells are highlighted in the simplified view and the **Cell properties** section of the menu becomes active.

The font can be changed with the **Font...** button and [hyperlinks](#) and [conditional formatting](#) applied to the cell text using the **Hyperlink...** and **Conditions...** buttons.

By default all cells will have the same width and height but you can use the **Width** and **Height** spinboxes to alter the width of this cell (and hence the width of all cells in the same column) and the height (and hence the height of all cells in the same row). To reset widths and/or heights back to be the same use the **Reset heights** and **Reset widths** buttons in the **Attributes** section.

Instead of just using text in the generated data you can run a program instead which could be a [standard library program](#) or an [external program](#). In this case the output from the program will be put in the table cell instead. To use a program change the Cell type from **Text** to **Program** using the popup. Once this is done the **Choose...** and **Library...** buttons and the **Program arguments** section become active. For library programs the output from the script can be mixed with other text.

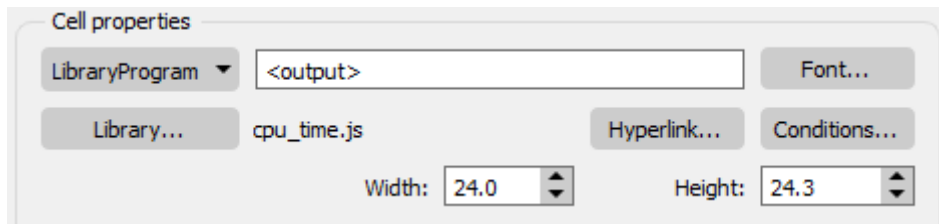

By default the cell text is shown as `<output>` . This will be replaced by the output from the script. Additionally you can prepend or append text to this to add to the cell.



9.7.6. Merging Cells

Merging cells

Cells in a table can be merged together into a single cell. Select the cells that you want to merge by either clicking and dragging the cells to merge or by Shift or Ctrl clicking on multiple cells in the **Cells** section. Note that the cells you want to merge must be a rectangular selection. Right click on the selected cells in the **Cells** section and choose **Merge cells** from the context menu.

Cells that have been merged together can be unmerged by selecting the cell, right clicking and choosing **Unmerge cells** from the context menu.



9.7.7. Cell Borders

Cell borders

To change the border for all the cells in a table you can use the normal [line thickness](#) control in the [Style toolbar](#). The borders for individual cells can also be changed if required. Select the cells that you want to change the border for in the **Cells** section, right click on them and select **Edit borders** from the context menu. This displays the **Cell Borders** menu.

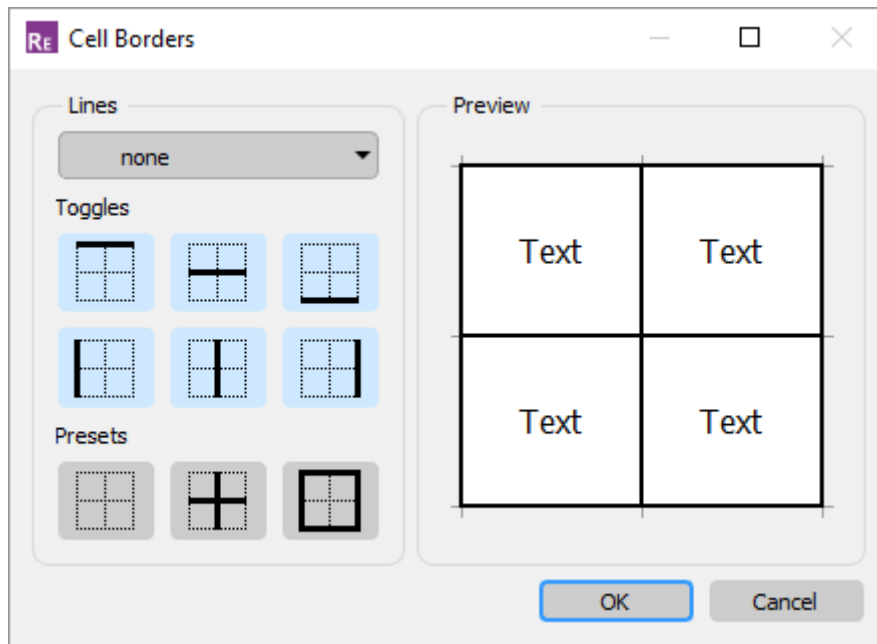

This menu allows you to change the cell borders for each side of the cells individually. First set the line thickness using the **Lines** combobox. The **Toggles** and **Presets** can then be used to change the borders. Press **OK** to update the cell borders.



9.7.8. Saving to CSV or XLSX

Saving to CSV or XLSX

To save the contents of a generated table to a CSV or XLSX file (e.g. for use in Excel), use the 'When generating save to CSV/XLSX file:' checkboxes at the bottom of the table menu. Ticking these checkboxes activates the adjacent text windows, into which a save location can be manually entered (or selected using the 'Choose' buttons).

9.8. Autotable Objects

Autotable objects

Enter Autotable information

Attributes

Name: Margins...

Directory: Choose...

Column properties

Fix overall table width while adding/deleting/resizing columns

ZONE
X
Y
Z
HIC

Add Remove Move up Move down

Column header properties

Name: Font...

Width: Reset

Column generated data properties

Text: Font...

Choose... Library... Hyperlink... Conditions...

Arguments

Add Remove Edit

Geometry

Bottom left X: Bottom left Y:

Width: Height:

Header height: Generated data height:

When generating save to CSV file: Choose...

When generating save to XLSX file: Choose...

OK Cancel



An autotable object in REPORTER is a table which REPORTER will create when the report is generated. An an example, you may want to run multiple analyses and produce a summary table with one line in a table for each analysis. The autotable object allows you to do this.

The above image shows the menu to create a table for a set of pedestrian headform analyses. We want to create a table with 5 columns (as shown below) ; the impact zone, the x, y, and z impact points and the calculated HIC.



ZONE	X	Y	Z	HIC
<u>C1A</u>	899.984	1393.17	895.182	4666.223
<u>C1B</u>	841.037	1276.24	896.854	1055.947
<u>C1C</u>	694.404	1399.28	851.726	343.4052
<u>C1D</u>	703.138	1308.79	861.869	627.7126
<u>C2A</u>	804.945	1171.9	898.937	476.1642
<u>C2B</u>	788.008	1057.62	903.647	467.8154

To do this we would run each of the analyses and post-process them with a REPORTER template. Each analysis would calculate the ZONE, X, Y, Z and HIC and store them as [variables](#). These variables would then be [saved to a file](#) called `reporter_variables`. The autotable object in the summary template can then pick up these `reporter_variables` files and use them to create the table rows. One row will be created for each file that is read.



9.8.1. Selecting Variables Files for the Table

Selecting variables files for the table

To create the autotable you need to select where REPORTER will read the `reporter_variables` files from. This is done in the **Attributes** section.

Attributes

Name: Margins...

Directory Choose...

In this example REPORTER will look for any `reporter_variables` files recursively from the directory `/data/DEMO/CONFERENCE/PEDESTRIAN_HEAD/NCAP_RUNS_2` .

Alternatively you can select a file which will contain a list of filepaths for REPORTER to extract variables from. Each line of the file must point to a single directory containing a `reporter_variables` file, or a single file (of any name) in the `reporter_variables` format. Note that for the file case REPORTER does not look recursively from the specified directory, it looks in that directory only.



9.8.2. Setting the Header and Generated Row Heights

Setting the header and generated row heights

To set the height of the header row and any rows which are generated by REPORTER use the **Header height** and **Generated data height** options in the **Geometry** section.

The screenshot shows the 'Geometry' section of a software interface. It contains several input fields with numerical values and up/down arrows for adjustment. The fields are arranged in two columns. The left column contains 'Bottom left X: 8.0', 'Width: 166.3', and 'Header height: 10.0'. The right column contains 'Bottom left Y: 29.0', 'Height: 250.0', and 'Generated data height: 8.0'. The 'Header height' and 'Generated data height' fields are highlighted with red rectangular boxes.

Property	Value
Bottom left X	8.0
Width	166.3
Header height	10.0
Bottom left Y	29.0
Height	250.0
Generated data height	8.0



9.8.3. Adding Columns to the Table

Adding columns to the table

To add a column to the table use the **Add** button in the **Column properties** section.

This will create a new column with the default name `Column 1`. This is what will be shown as the column header. You can change the name in the **Name:** textbox and change the font used with the **Font...** button.



Once the column has been created you can decide how the data should be generated. Continuing the example above the first column is the zone so we change the column name to ZONE. The individual analyses that were post-processed by REPORTER saved the zone for the analysis in the variable ZONE, so for the generated data we want to input the text %ZONE% which means the value of variable ZONE. REPORTER will first look for any variables in the `reporter_variables` file. If it finds the variable then the value will be used. If REPORTER cannot find a variable in the `reporter_variables` file it will then look for a variable with the same name in the current template and use that value.

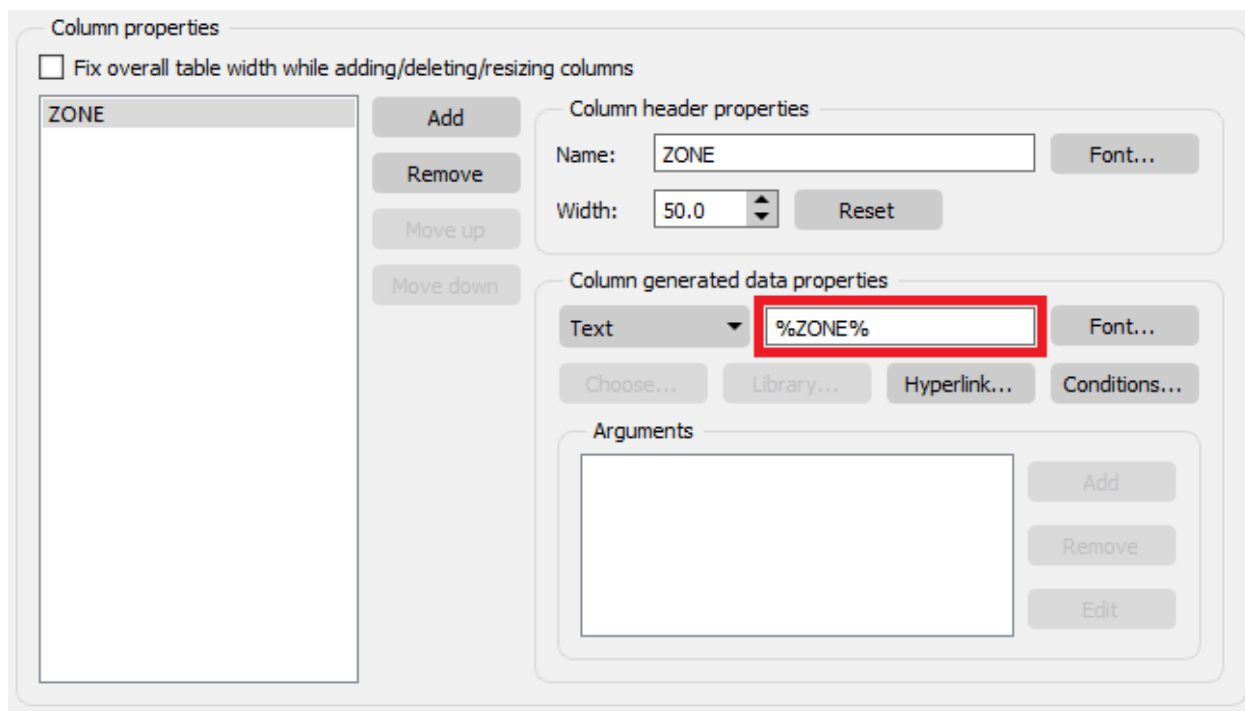

The font can be changed with the **Font...** button and [hyperlinks](#) (e.g. see the ZONE column in the above example output) and [conditional formatting](#) (e.g. see the HIC column in the above example output) applied using the **Hyperlink...** and **Conditions...** buttons.

Instead of just using text in the generated data you can run a program instead which could be a [standard library program](#) or an [external program](#). In this case the output from the program will be put in the table instead.

You can add as many columns to the table as necessary in exactly the same way.



9.8.4. Using the 'Fix Overall Table Width...' Checkbox

Using the 'Fix overall table width...' checkbox

The functionality of the 'Fix overall table width while adding/deleting/resizing columns' checkbox is similar to that of the 'Fix overall table size...' checkbox for tables, except that the autotable checkbox only affects columns. The checkbox has no affect on row height (or overall autotable height); these are instead controlled through the various height options in the Geometry section.

9.9. Script Objects

Script objects

Edit script object information

Attributes

Name:

automatically run when template opened

show as button in presentation view

do not run when template or page is generated

Button text:

Script

```
var i;
for (i=1; i<=10; i++)
  LogPrint("The value of i is " + i);
```

Geometry

Bottom left X:

Bottom left Y:

Width:

Height:





Script objects are JavaScript scripts that REPORTER can run using an embedded JavaScript interpreter. REPORTER also extends JavaScript by defining a number of classes for things specific to REPORTER. See the JavaScript API reference manual for a reference to these classes.

To insert a script, select the Script tool and then click and drag an area on the page. This will draw the area that the Script item will occupy and then map the script window.

You can load a script into the window with the **Load...** button and save the script to file with the **Save...** button. Scripts do not make any output on the page themselves (i.e. the area on the page that the script occupies will not have anything drawn on it from the script) but they can create output indirectly. For example, a script could create an image using the Image class in REPORTER and then this image could be imported with an [Image File object](#).

Scripts do become visible on the page if you select 'show as button in presentation view'. If this checkbox is selected, then the script will run when the user clicks on the button. If you also select 'do not run when template or page is generated', the script will only be run when the button is clicked.

You can select one Script object in your template to be run automatically when the template is opened. REPORTER will only automatically run the first Script object it finds with this checkbox selected.

As a simple example, the script above prints text to the [logfile window](#) using the LogPrint function (global class function). This doesn't do anything useful in itself but shows how you can produce useful diagnostic messages. This generates the following output in the [logfile window](#):

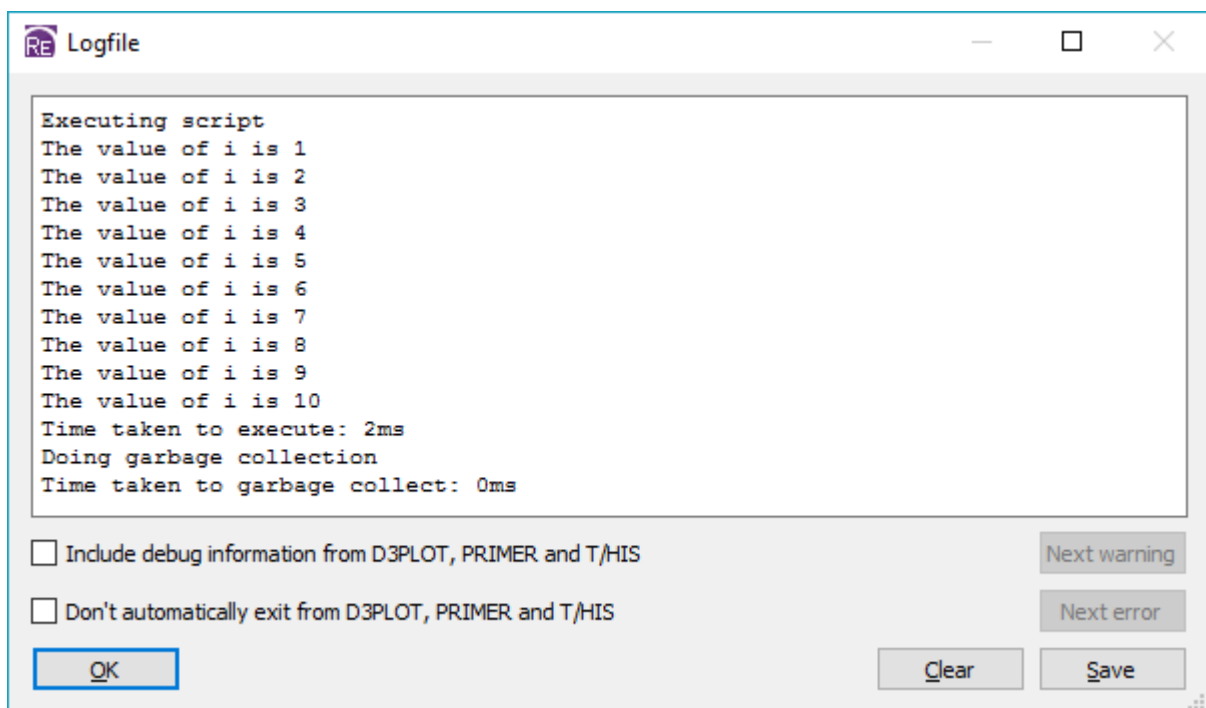



For more information on scripting, see [Scripting](#). See also [Script File objects](#), which have all the same features as Script objects, except that they allow you to refer to an external script file rather than embedding your script directly in the template.

9.10. Script File Objects

Script File objects

Edit Script File item information

Attributes

Name:

automatically run when template opened

show as button in presentation view

do not run when template or page is generated

Button text:

Script file

Geometry

Bottom left X: Bottom left Y:

Width: Height:



Unlike PRIMER , D3PLOT and T/HIS , REPORTER does not support the Use() function, or JavaScript modules. To help address this, a Script File item has been added, available from REPORTER 19.0 onwards. Script File items have all the features of [Script items](#) , except that rather than containing an embedded JavaScript, they point to an external script file. This allows you to edit the script in your preferred editor. Furthermore, since the REPORTER JavaScript environment persists for the duration of the REPORTER session (and is shared by all scripts), you can create one or more Script File items containing any common functions, followed by one or more Script File items that use those functions. This should provide much of the benefits of the Use function and JavaScript modules available in PRIMER , D3PLOT and T/HIS :

Multiple Script File items

```
Name: scriptfile1
Script file: %TEMPLATE_DIR%\scripts\common_functions.js
```

This script file contains all of the common functions used by subsequent scripts, so make sure it's generated first

```
Name: scriptfile2
Script file: %TEMPLATE_DIR%\scripts\useful_script.js
```

These script files can then make use of any common functions or global variables defined in earlier scripts

```
Name: scriptfile3
Script file: %TEMPLATE_DIR%\scripts\another_script.js
```

For more information on scripting, see [Scripting](#).

9.11. Note Objects

Note objects



RE Enter text

Attributes

Name:

Text properties

Note:

Geometry

X1: Y1:

OK Cancel



Note objects are used to add simple notes to your REPORTER template. They are only displayed in design view. To add a note when in design view, click on the note icon and click on the position on the page you wish to add a note. The following window will be mapped:

The name is what is displayed on the screen. The note is what is displayed when you hover the mouse over the note on the screen:

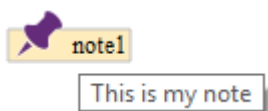



9.12. Placeholder Objects

Placeholder objects



Placeholder items are used in many of the library templates provided with REPORTER . If you choose one of the templates from the **Standard** tab, you will see Placeholder items are used to predefine the page layout. Then, depending on what you want to add to the page, the Placeholder item can be converted into any other item type.

When using D3PLOT and T/HIS to capture plots and graphs, select a Placeholder item and then click **Capture** in D3PLOT or T/HIS . The Placeholder item will automatically be replaced by a D3PLOT or T/HIS item respectively.

You can also convert Placeholder items into PRIMER items, Tables, or indeed any other item type. Double-click on a Placeholder item to edit it, and then use the **Convert into...** drop-down menu to choose another type of item. When you click **OK** , the item will be converted.

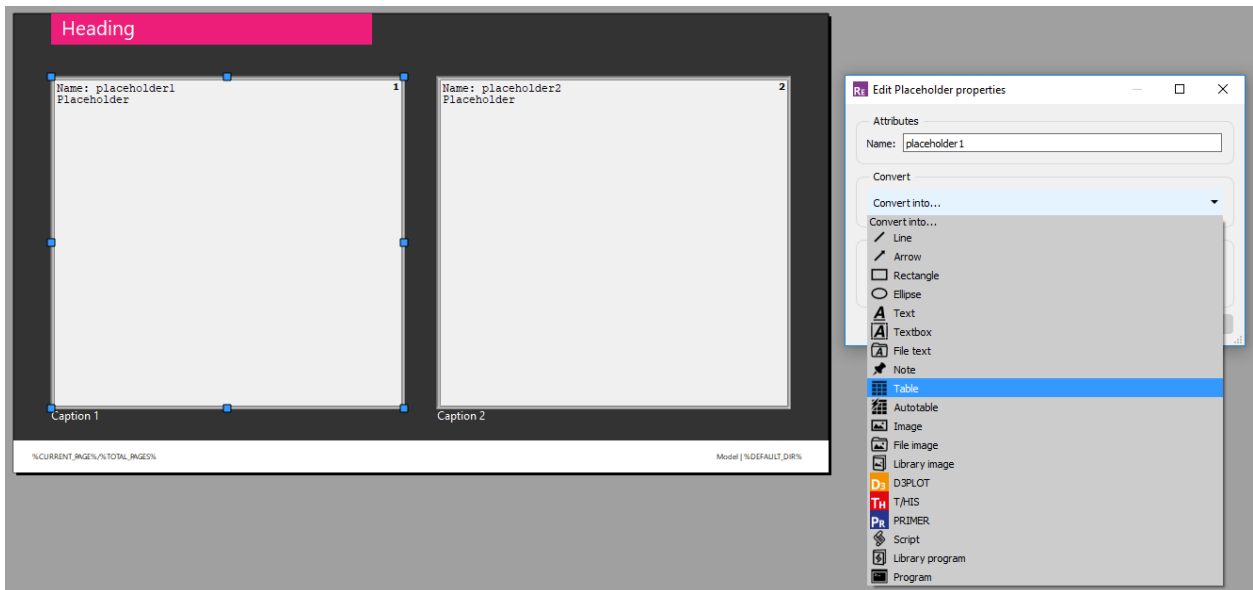

10. Undo

Most actions can be undone in REPORTER. You can carry out the undo/redo functionality in the following places:

- The **Undo toolbar**. Here you can use the **Undo** button to undo the most recent action, the **Redo** button to redo the most recently undone action, and the **Undo History** button to map the undo history view to allow you to traverse through the different states of your REPORTER session.
- Via the **Edit** menu.
- The **Ctrl + Z** (undo) and the **Ctrl + Y** (redo) keyboard shortcuts.

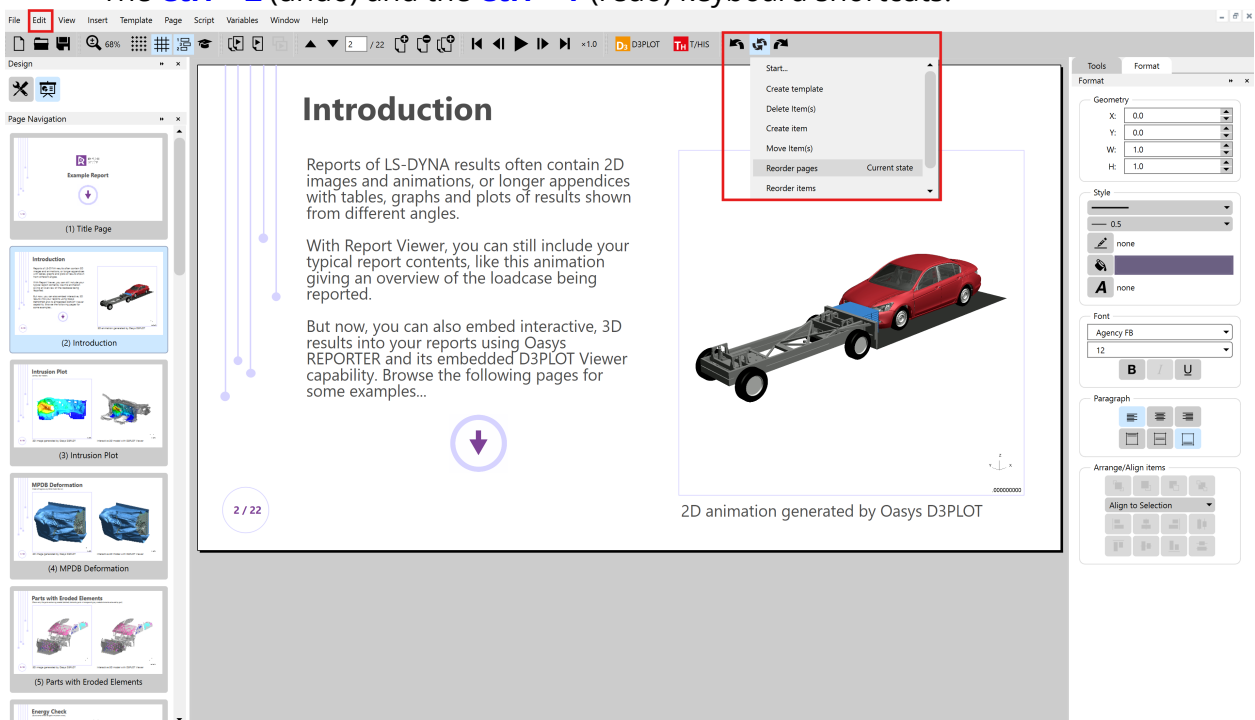

When you generate your report/template, run scripts, or have a gRPC server on, the undo stack will be cleared.

The following table lists all the undoable actions in REPORTER:

#	REPORTER Action
1	Creating items
2	Deleting items
3	Edit item properties via the Edit dialogs



4	Edit items via the Formatting dock widget
5	Arranging items in front of or behind each other
6	Moving items to pages
7	Moving/resizing of items
8	Converting items
9	Cut, copy, and paste items
10	Nudging items
11	Capturing over an existing item of a different type
12	Capturing over an existing item of the same type
13	Capturing a new item into REPORTER
14	Importing item(s)
15	Adding and duplicating pages
16	Deleting pages and deleting all pages
17	Importing pages
18	Reordering items
19	Reordering pages
20	Editing page properties
21	Editing page setup
22	Editing template properties
23	Creating a template
24	Deleting a template
25	Creating a variable
26	Deleting a variable
27	Editing a variable
28	Deleting temporary variables
29	Search and replace



11. Search

Search

Navigate REPORTER with ease using the Search capability available in several menus:

- Search for **library templates** and **recent files** in the [Choose a Template dialog](#)
- [Search and replace text within templates](#) and **reports** (shortcut **Ctrl + F**)
- Sift through dozens of **Variables** quickly with [search in the Variables dialog](#)
- Search for **messages** in the [Logfile dialog](#) to check templates are generating correctly
- Search **everything from the main window toolbar** (**Ctrl + Shift + F**) to quickly execute actions, find in document, or find library templates
- The [search algorithm](#) helps you surface relevant results

Search for templates and files

The [Choose a Template](#) dialog search bar will filter through the recent files and the library templates in the **All** tab at the same time. The search results will be cleared every time you switch tabs or you close the dialog. If you're currently in a tab other than **All** then when you search, the tab will automatically switch to the **All** tab. If you wish to search for a specific template **type**, you can add this extra filter from the filters tree. The search returns results based on template titles and descriptions.

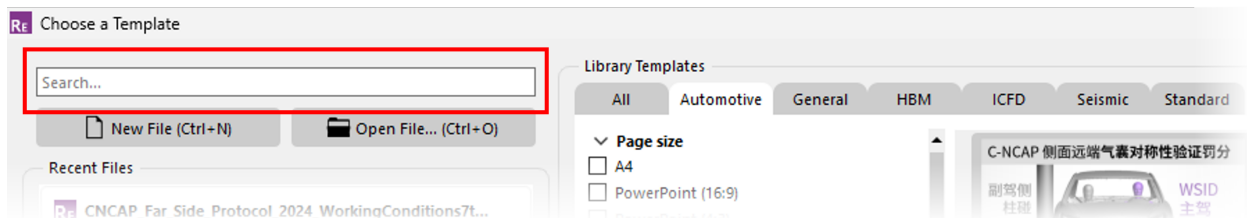

Search within templates and reports

The Search and Replace function allows you to search for a text string (or variable) that could appear in any item in the template (or report) and replace it with another string (or variable).

For example, you might make a template which contains D3PLOT items that have the directories hard-wired instead of using a variable for the directory. If you want to generalise the template you can use [Search and Replace...](#) to replace every instance of the directory name in the template with a variable.

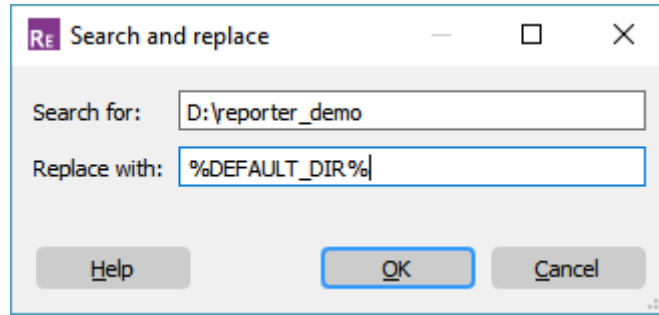

To perform a search, select **Edit** → **Search and Replace...** or use keyboard shortcut **Ctrl + F**.

Enter the search and replace strings in the dialog box. You can insert a variable if required by right-clicking in the text box and selecting **Insert Variable**.

Each time REPORTER finds an instance of the string within an item in the template, a confirmation dialog will appear giving you the option to replace or skip the string. The item will be selected on the screen so you can see which item you are replacing text in, and a brief text description will be given for the item and field that you are looking at.

Cancel will abort the Search and Replace operation. Clicking **Yes** will perform the replace; clicking **No** will skip this instance. If you want to replace all instances without confirming each one in turn, then click **Yes to All**.

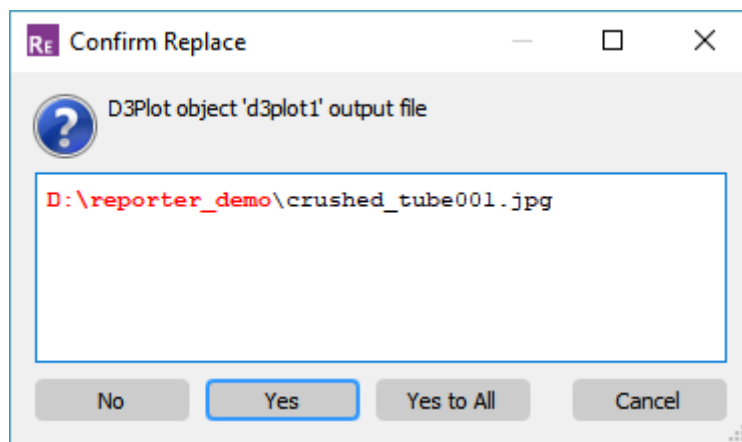

Search for Variables

The [Variables](#) dialog allows you to both sort the results by clicking on the header names and to filter the items via the bottom search bar. The search will still work dynamically if you add/delete/edit variables. The search results will be cleared when you close the dialog or when you press the **x** button in the search bar. The search returns results based on the name, description and value of variables.

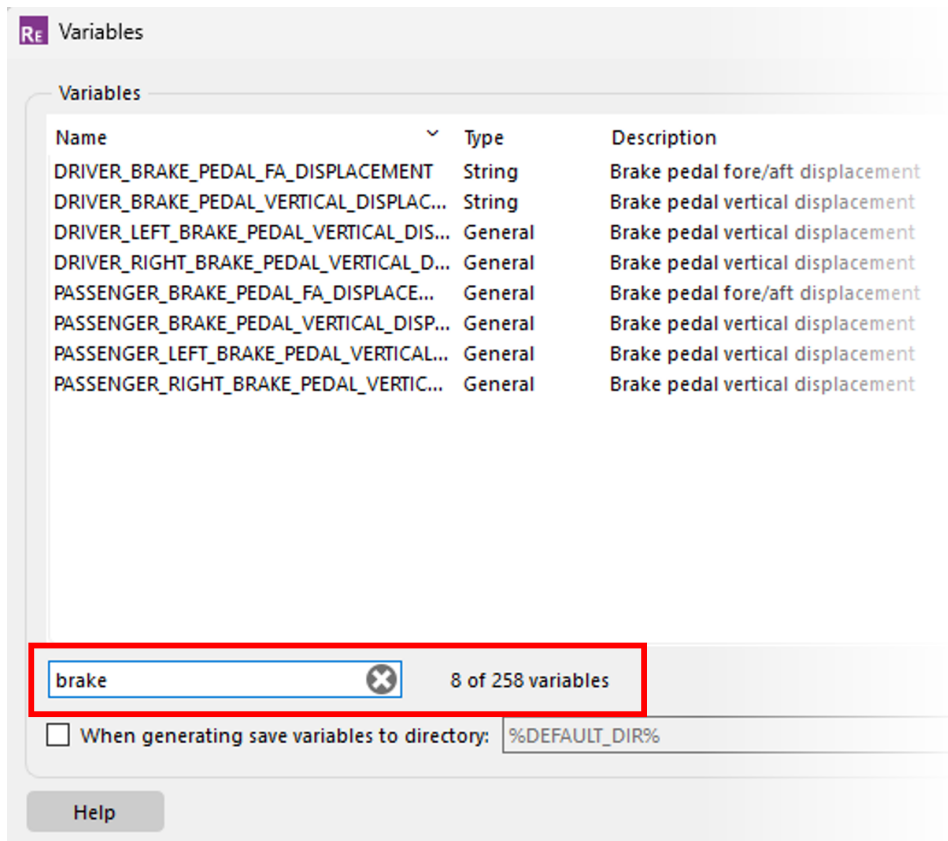

Search the Logfile

Searching in the [Logfile](#) dialog will move you to the position of the first search result and allow you to navigate through the search results using the up and down arrows next to the search bar. All matching results are highlighted with a yellow background, and the current result is highlighted in red text:

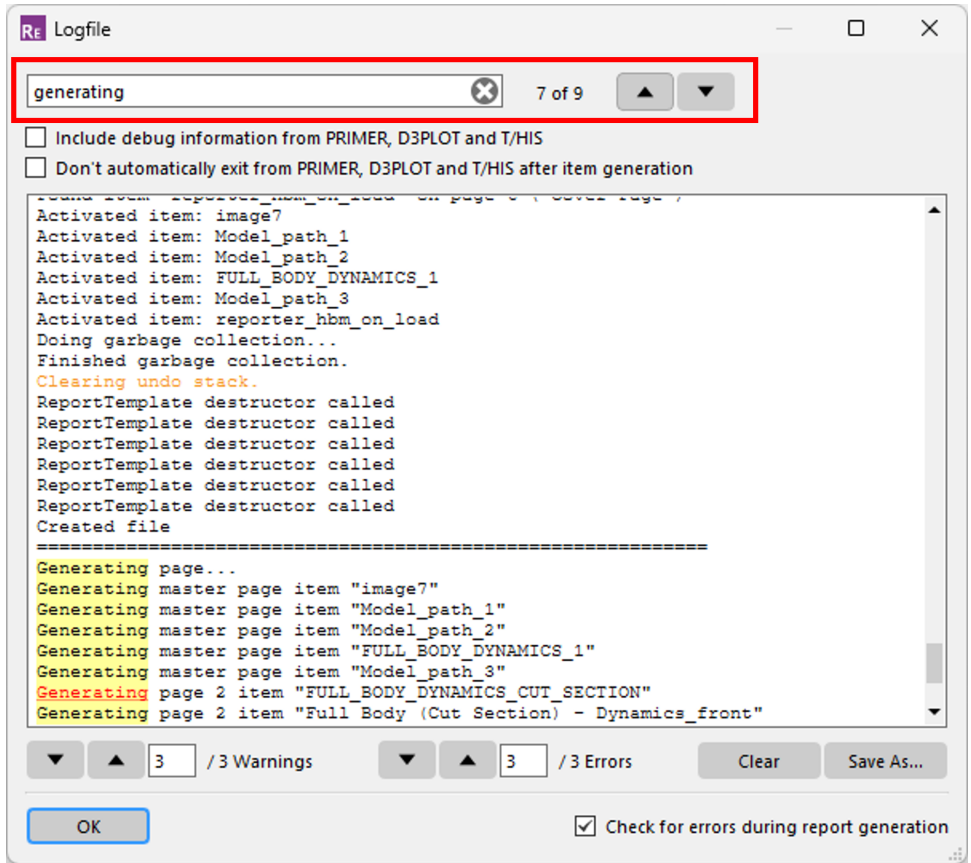

Search Everything

The main window toolbar contains a global search bar which will find relevant actions and submenus, as well as allowing you to redirect the query to the templates and files search or to the in-document search. This global search bar can also be accessed via the key shortcut **Ctrl + Shift + F**.

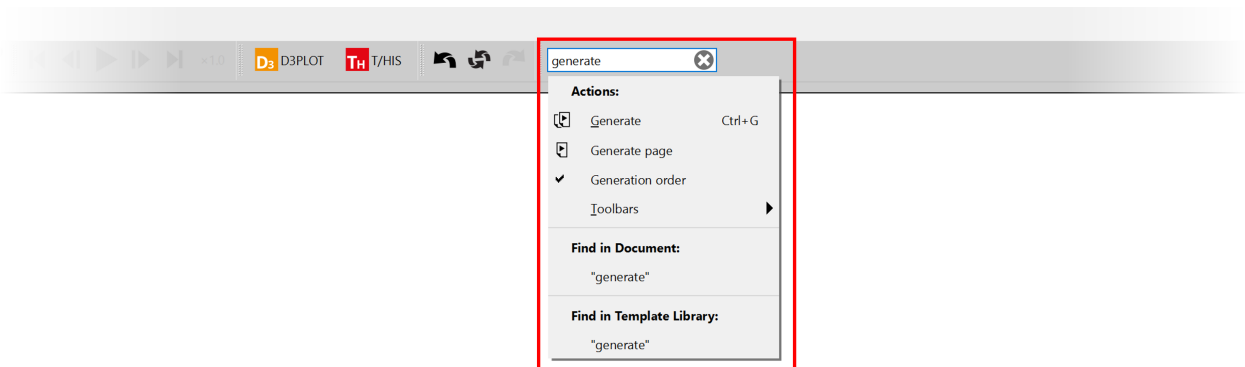

Search Algorithm



The search in all dialogs apart from the Logfile dialog works in a "fuzzy" way, allowing small differences between your search text and the matching results. All dialogs perform case-insensitive search.



12. REPORTER Integration

REPORTER INTEGRATION

This section describes how to work with D3PLOT, T/HIS and REPORTER to quickly and easily create reports from results.

12.1. Linking the Programs

Linking the Programs

REPORTER can be opened from D3PLOT and T/HIS using the REPORTER button in the top-right. This opens a linked session of REPORTER, allowing reports to be interactively created and edited. Both D3PLOT and T/HIS can be opened from inside REPORTER too, using the program buttons in the top bar of REPORTER. REPORTER can be connected to both D3PLOT and T/HIS at the same time and the D3PLOT->T/HIS link is also supported. Graphs in T/HIS are treated the same as graphs in a D3PLOT->T/HIS linked session.

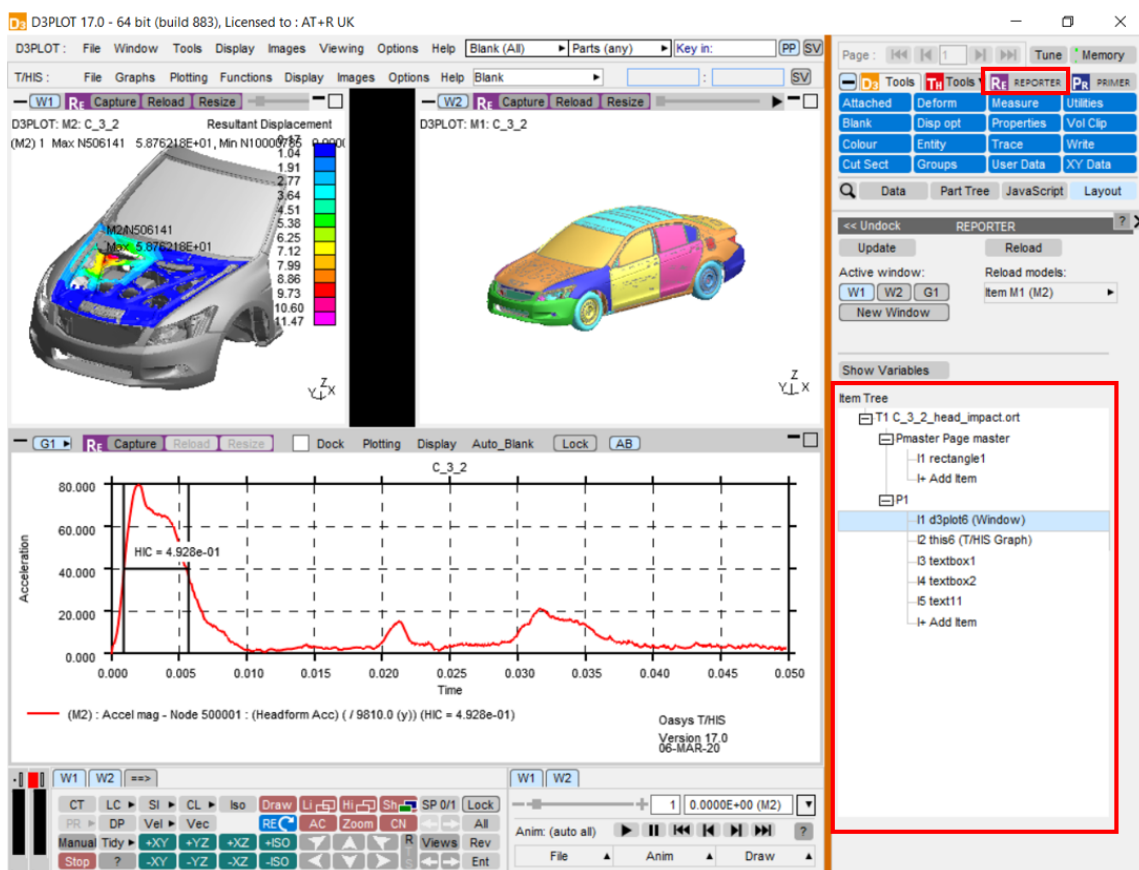



12.2. Item Tree

Item Tree

Once a template is opened in REPORTER, all items in the template will appear in the Item Tree in the REPORTER panel in D3PLOT or T/HIS. Selecting an item in the Item Tree will select the corresponding item in REPORTER and vice-versa.

The Item Tree can include items of all types in REPORTER, such as textboxes and images, as well as D3PLOT, T/HIS and PRIMER items. Only placeholders, D3PLOT items and T/HIS items can be overwritten with new D3PLOT or T/HIS items. Placeholder items exist to allow a layout to be created for the report before populating it and can be converted into any other item type.

12.3. Capture

Capture

Windows and graphs can be captured into REPORTER, saving an image together with additional information to allow the capture to be reloaded later. For D3PLOT windows, this is a properties and settings file. For T/HIS graphs, this is a FAST-TCF script. Graphs captured in the D3PLOT->T/HIS link are treated exactly the same as graphs in T/HIS, so the resulting items will be identical. [Variables](#) containing useful values related to the models or curves in the captured window can be added to the item before capturing (see [Variables](#)).

Note that in the version 17.0 method, only single windows and graphs can be captured. The intention being that the windows and graphs are easily captured individually and laid out in REPORTER with greater flexibility.

In order to capture a window, first select the target item in REPORTER, either selecting it directly in REPORTER or using the item tree. You can capture into a new item by selecting 'I+ Add Item' in the item tree. Once the item is selected, the 'Resize' button on the top bar of the window can be used to resize the window to match whatever image size is specified on the selected REPORTER item, such as 'Fit object box'. Finally, either press 'Capture' on the top bar of the target window or select the window in the 'Active window' list in the REPORTER panel and press 'Capture' at the top of the panel.

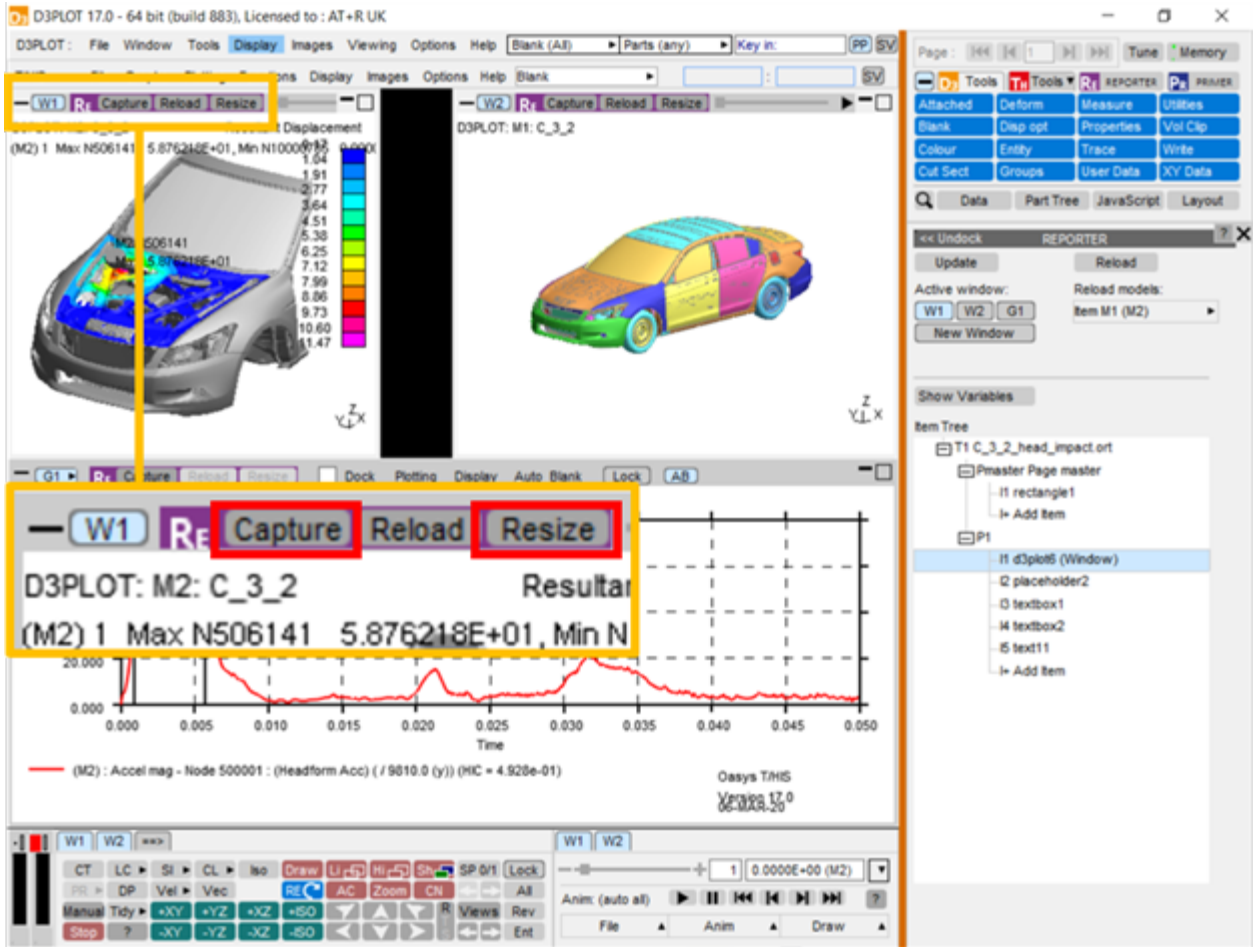

This will send the information to REPORTER and the image will appear on the item.

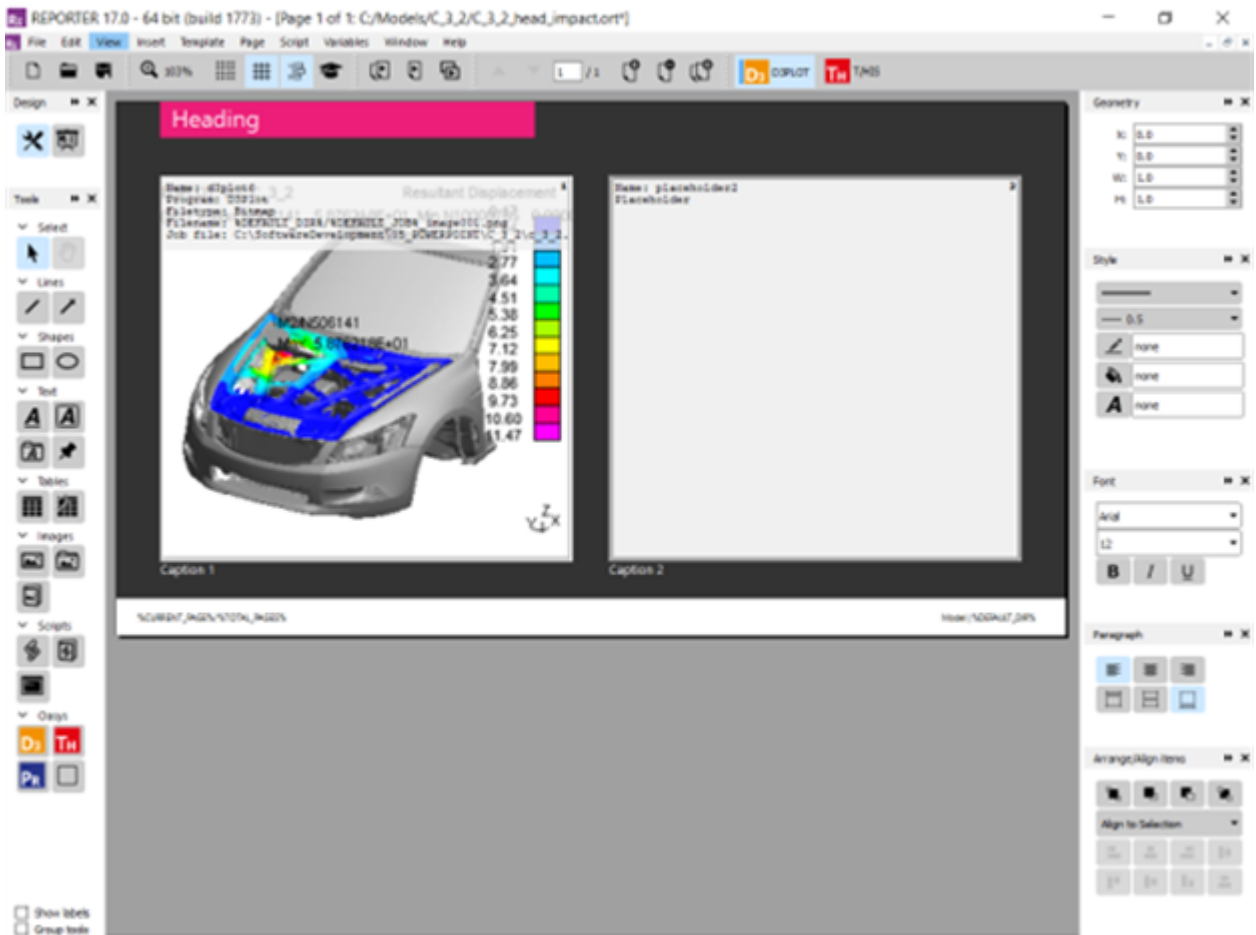

12.3.1. Capturing Movies

Capturing Movies

Starting with D3PLOT 18.0, MP4 movies and animated GIFs can be captured with a D3PLOT Item in REPORTER in place of a static image. The process for Capture is unchanged: just right-click on the Capture button in D3PLOT (either in the REPORTER panel or at the top of the target window) to reveal the new Movie (MP4) and GIF options.

When selecting an existing D3PLOT Item in the REPORTER Item Tree, the Update Capture button will always update to switch to that Item type (Image, Movie, or GIF). Left-clicking the Update Capture button will then replace the current capture with one of the same type without the need to use the drop-down menu again. The drop-down menu can be used if switching type (e.g. PNG Image to MP4 Movie) is desired.

Settings such as frame rate and quality are determined by their current status in the Images -> Write -> Movies panel so be sure to check these before performing a Capture.

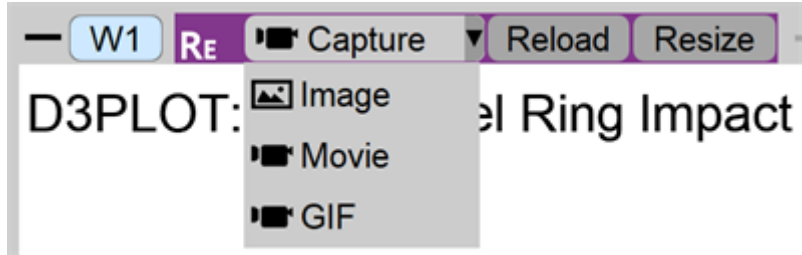

12.4. Reload

Reload

Existing REPORTER items can be reloaded back into D3PLOT or T/HIS. Items captured from graphs in the D3PLOT->T/HIS link are treated the same as items captured from standalone T/HIS. As such, they can each be reloaded either into D3PLOT or T/HIS.

First select the item in REPORTER that you want to reload.

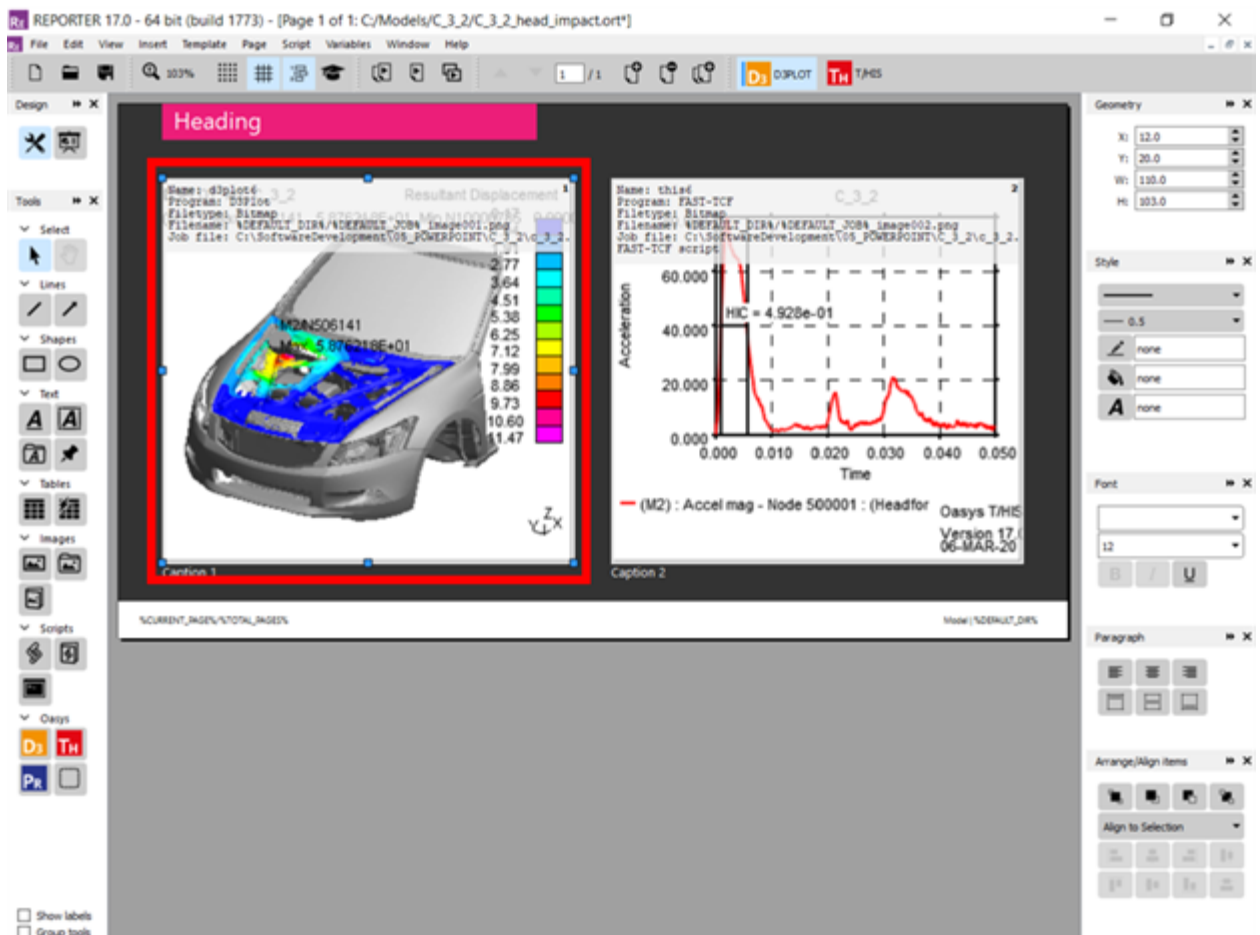

Then either press reload at the top of the target window, or select 'New Window' in the Active window list.

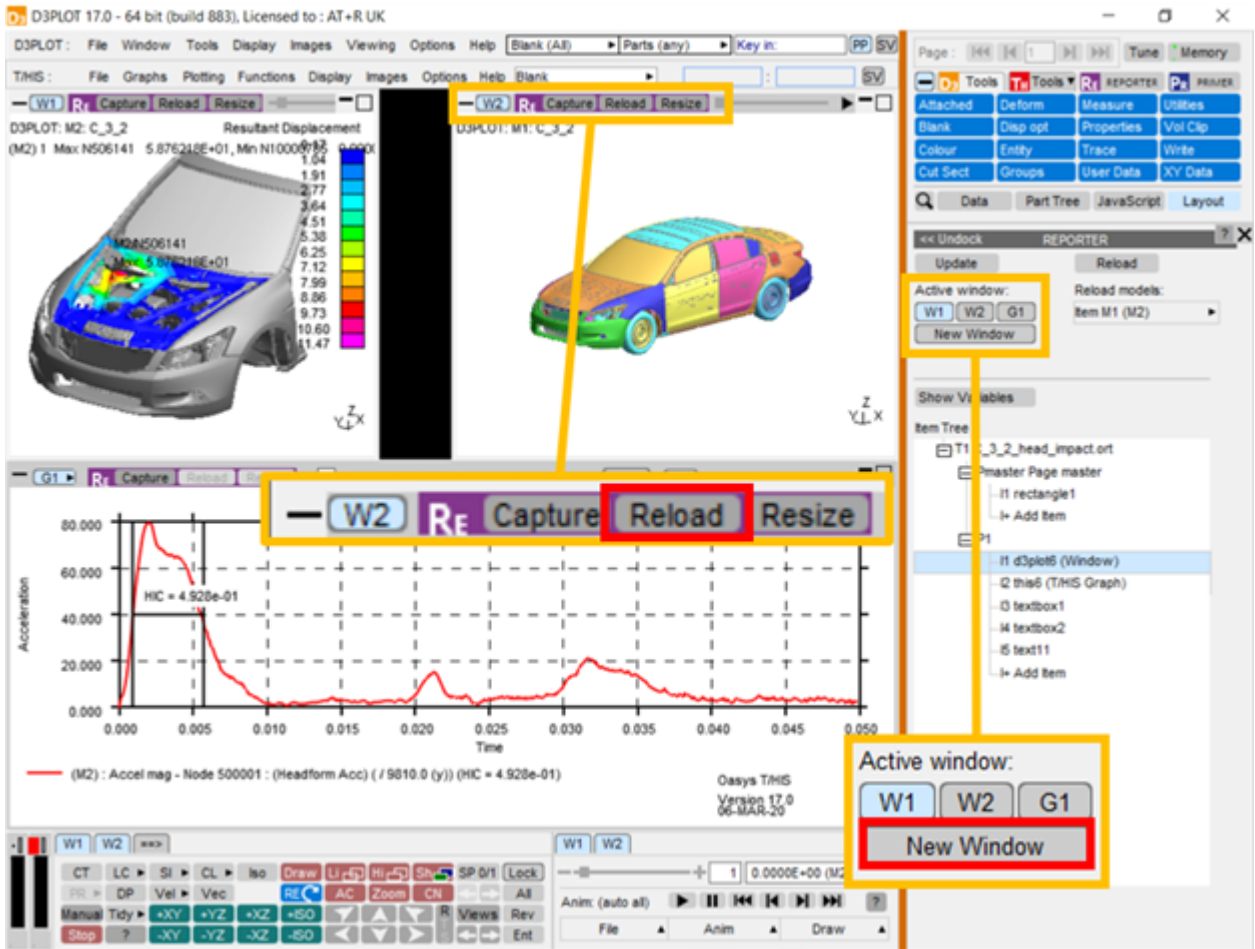

This will clear the target window, open the relevant models, not opening them again if they are already open in the session, then load the stored item information, reproducing the capture.

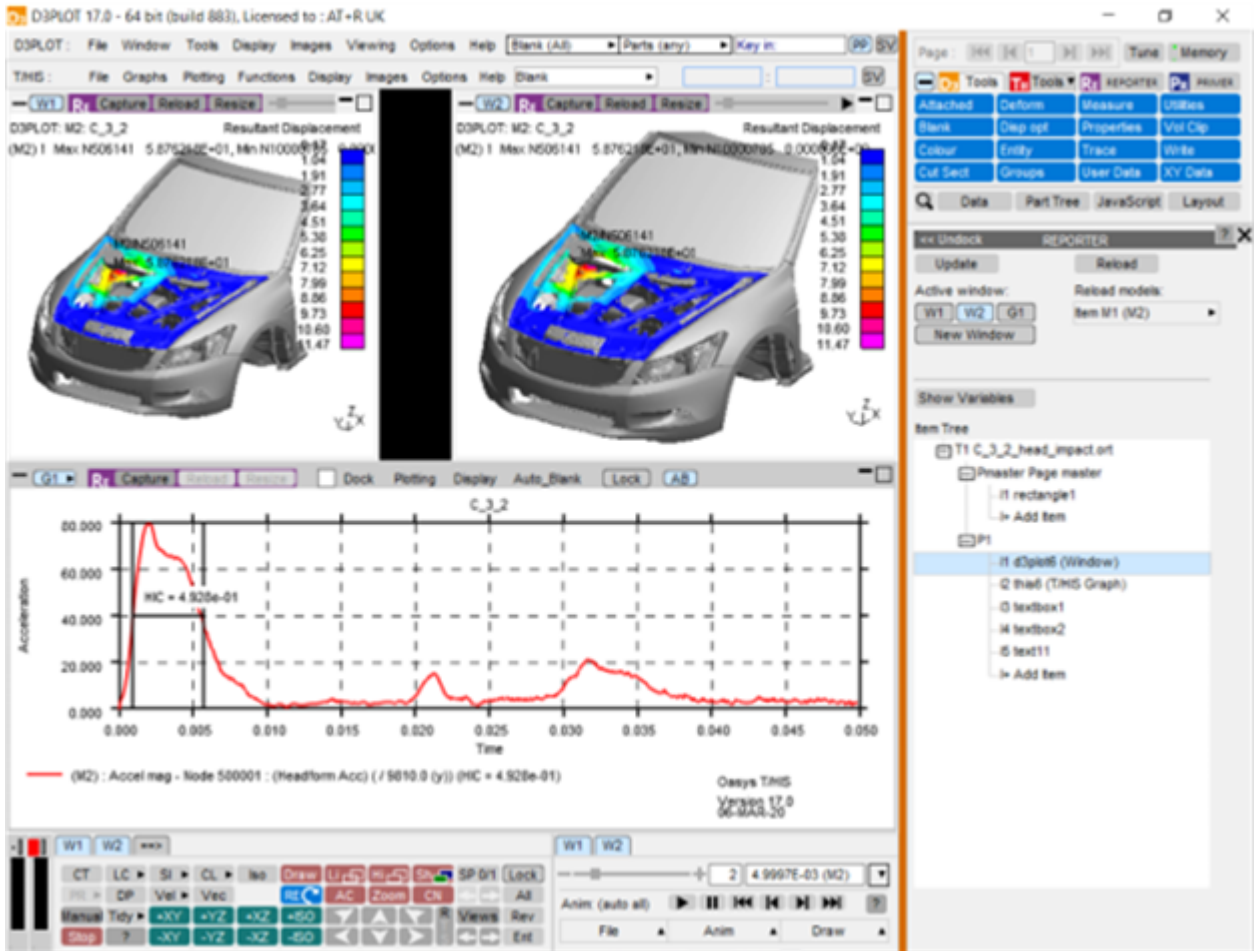

12.4.1. Reload Models

Reload Models

The models used in an existing item are listed in the Reload models list. The models will be listed as Item Mn, where n is the index of the model in the item, not of the model in the session. If the model is also open in the current session, then the model ID in the current session will be displayed in brackets.

Each entry in the list has a popup attached, allowing the model to be replaced either by a model in the current session or by browsing for a model. This will not change the models stored in the item, but instead when the item is reloaded into the current session the replacement models will be used. The resulting window will then need to be captured, either into a new item or to overwrite the original.

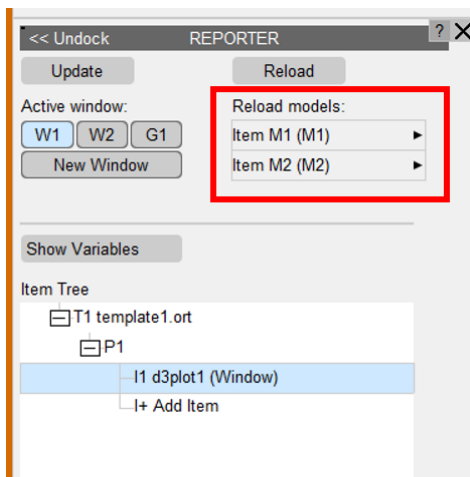

12.5. Generate

Generate

Once a complete template has been created, it can be generated using File >> Generate in REPORTER. This will generate in an existing session if there is one, otherwise a new session will be started. T/HIS items will be generated in standalone T/HIS, unless the T/HIS link is already open in D3PLOT, in which case they will generate in the link. It is faster to generate in standalone T/HIS.

12.6. Variables

Variables

Variables can be added to both D3PLOT and T/HIS items, allowing data related to the capture to be made available in REPORTER. The REPORTER panel can be undocked and expanded to display the variables list by selecting Show Variables.

For T/HIS items, variables can be added containing properties of any of the curves in the selected graph or all the curves combined using the All Curves option. By default, T/HIS items will have variables for the MAX and MIN values taken over all curves in the selected graph. When selecting the curve for a newly created variable using the curve popup, curves are referred to as ICn, meaning Item Curve n, where n is the index of the curve in the selected graph. The curve label and number in the current session are also displayed in the popup.

For D3PLOT items, variables can be added for the MAX and MIN values of any of the plotted data components on any of the models. By default, D3PLOT items will have variables for the MAX and MIN values of all plotted data components for each model in the selected window.



Variables can be added using the + button and deleted using the X button next to the row.

Initially, variables will appear under New Variables until the item is captured, when they will move to Existing Variables. Variables will be given default names based on their item name in REPORTER (e.g. d3plot6_1, this4), variable type and model/curve that they relate to. However, these names and descriptions can be manually edited.

For D3PLOT items, the Entity ID and Entity Type tickboxes can be used to create additional variables to contain this information. These will have the same name as the original variable with either `_ENT_ID` or `_ENT_TYPE` appended.

For T/HIS items, the Add variables containing curve label tickbox will create an additional variable containing the curve label of the relevant curve, with `_LABEL` appended to the name.

Example of a D3PLOT item with two existing variables, referring to models in Window 1.

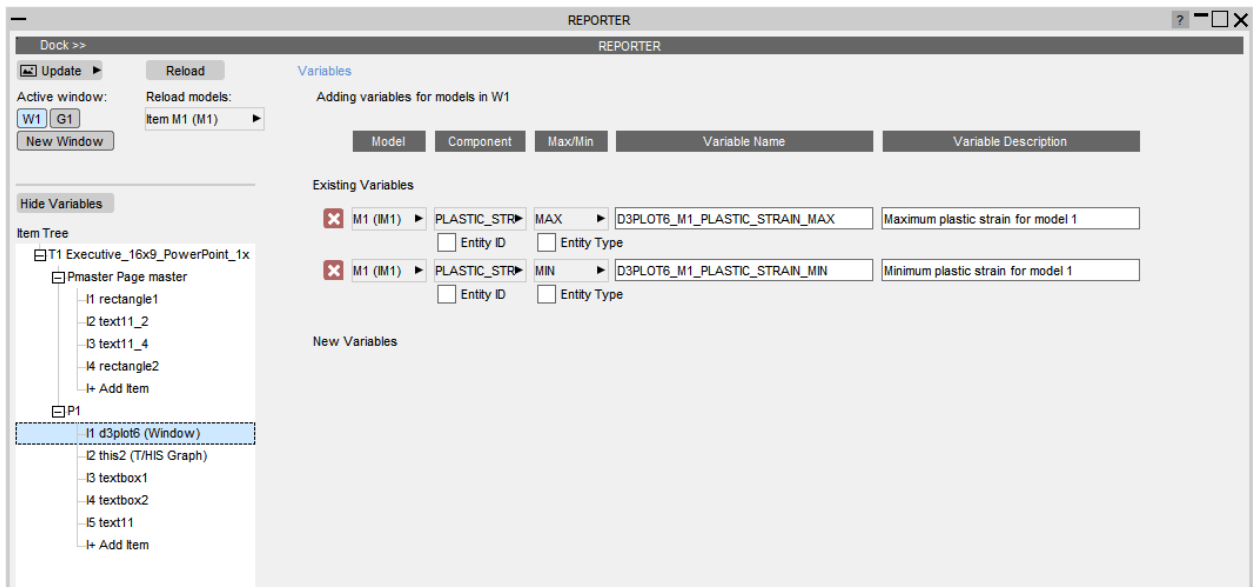

Example of a T/HIS item with two new variables and two existing variables, referring to curves in Graph 1.

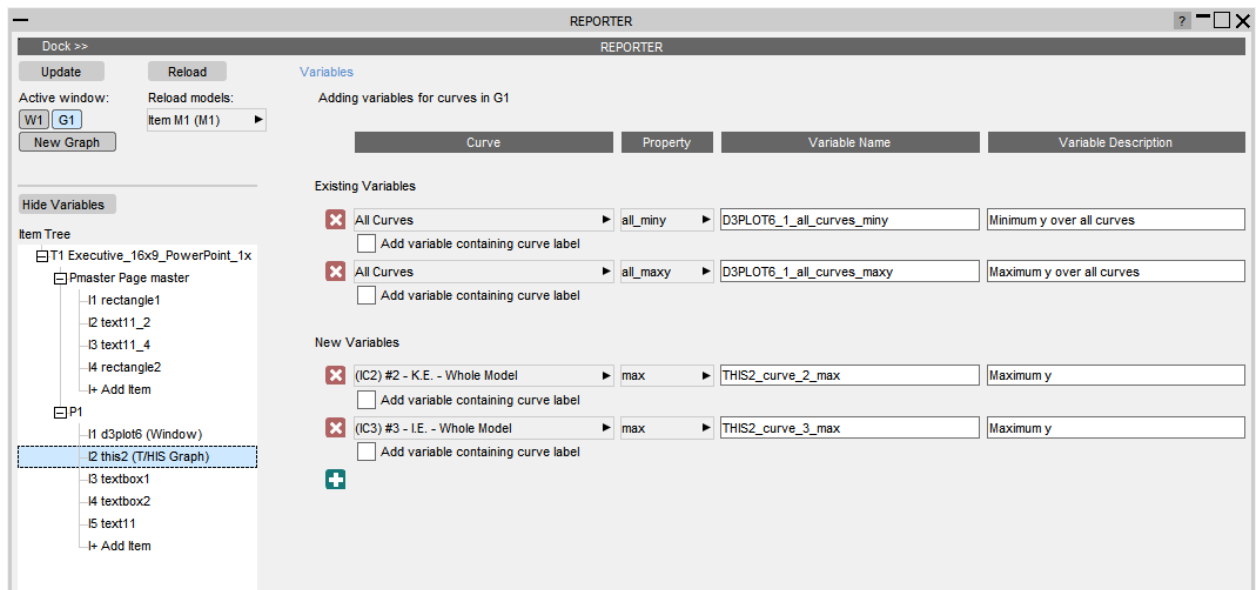

12.7. Exceptions to the Version 17 Method and Existing Templates from Version 16 and Earlier

Exceptions to the Version 17.0 Method and Existing Templates from Version 16.0 and Earlier

There are some item types that are not supported in the new Version 17.0 method. In this case, the Version 16.0 method will be used and nothing will have changed. These are:

- T/HIS JavaScript items
- Items containing multiple graphs/windows

Any item can be captured and generated using the Version 16.0 method by selecting the Capture and generate this item using the old method option in the object information in REPORTER.

Existing Version 16.0 and earlier templates should work exactly as they used to. All items will use the Version 17.0 method unless they meet one of the specified exceptions above. This gives some additional benefits:

- When generating the report, all supported items will be generated in the same session, without opening the same models multiple times. This will make the process faster.
- The report can be edited interactively using all the perks of the Version 17.0 method.

13. Generating and Outputting Reports

13.1. Effect of Object Order on Generating a Report

Effect of object order on generating a report.

The order the various objects are layed out on a page relates to the order in which they will be processed by REPORTER when it generates a report. So if you have a program/script that creates a variable in it's output, that program/script will need to be on the same page or an earlier page than the object that first uses the generated variable. If it is on the same page it also needs to be earlier in the order of objects on the page than any objects that uses that variable.

The following series of example shows what will and won't work. In all the examples Object 1 (red) and Object 2 (cyan) both use a variable (`VAR1`) generated by Script 1 (green) as an input.

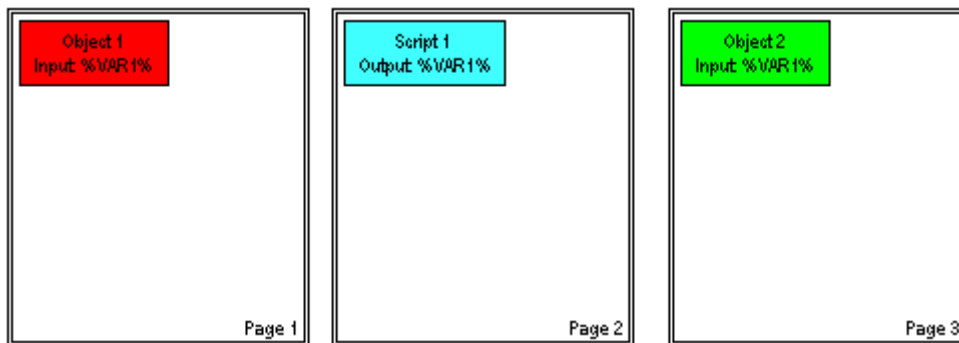

In this case Object 1 is on an earlier page than Script 1 so the variable `VAR1` hasn't been created yet. In this situation REPORTER will give a warning and uses a blank for the variable `VAR1` in Object 1. Object 2 however comes after Script 1 so the variable `VAR1` has been created and Object 2 can be generated normally

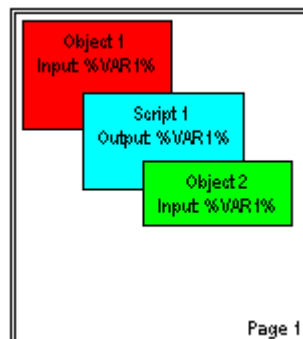

In this case Object 1 is on the same page as Script 1, but comes before it in the order of items on the page so there variable `VAR1` hasn't been created yet. In this situation REPORTER will give a warning and uses a blank for the variable `VAR1` in Object 1. Object



2 however comes after Script 1 in the order of items on the page, so the variable `VAR1` has been created, and Object 2 can be generated normally.

13.2. Generating Reports

Generating reports

Once a report template has been created a report can be generated by selecting the **Generate** option in the **File** menu.

Generating a file causes all of the objects on the page to perform any necessary actions to create the output for that object. For example:

- Text objects could expand variables into the actual values
- File objects would read the text/image file and show it
- Program objects would be "run" to generate the output.
- Tables will be created
- etc.

If any objects are to be created from D3PLOT or T/HIS then REPORTER will start the relevant program to produce the object and then insert the object into the report. REPORTER will also run any specified programs/scripts and insert the output into the report as required.

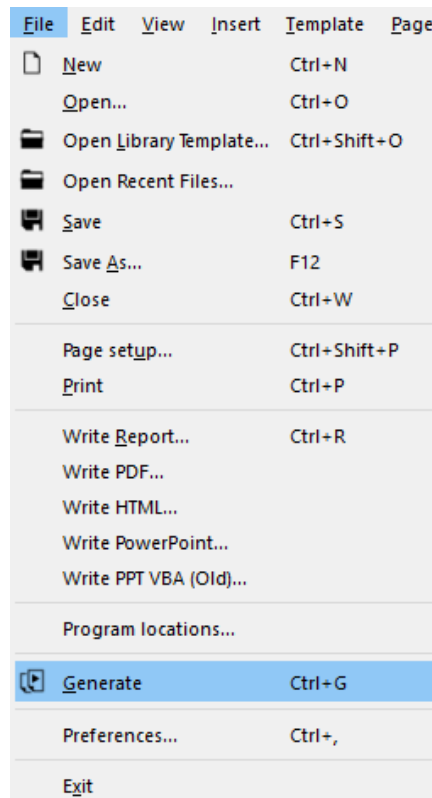



During report generation feedback is given in the status bar showing what REPORTER is doing. For example in the image below REPORTER is currently generating output for object 'oasys21' on page 1 and the report generation is 29% complete.



You can stop report generation at any time by pressing the **Stop** button in the status bar.

To switch between the the design view (showing the report template) and the presentation view (showing the final report) you use the Design buttons



The images below show an example of a report template before and after generating the page.

Design view before generating report:

Analysis information	
Model	
Directory	%DEFAULT_DIR%
Filename	%DEFAULT_JOB%
*TITLE	title.js %DEFAULT_DIR%/%%DEFAULT_JOB%.key
Hardware/Solver	
Machine	%HOSTNAME% (%CPU% CPUs)
Platform	platform.js %DEFAULT_DIR% os.js %DEFAULT_DIR%/%%DEFAULT_JOB%.otf
LS-DYNA version	version.js %DEFAULT_DIR%/! precision.js %DEFAULT_DIR%/%%DEFAULT_JOB%.otf
Computation	
Start time	start_time.js %DEFAULT_DIR%/%%DEFAULT_JOB%.otf
End time	end_time.js %DEFAULT_DIR%/%%DEFAULT_JOB%.otf
Elapsed time	elapsed_time.js %DEFAULT_DIR%/%%DEFAULT_JOB%.otf
CPU time	cpu_time.js %DEFAULT_DIR%/%%DEFAULT_JOB%.otf
Mass info	
Total mass	total_mass.js %DEFAULT_DIR%/%%DEFAULT_JOB%.otf
Initial added mass	initial_added_mass.js %DEFAI (initial_added_percent.js %DEFAULT_DIR%/%%DEFA
Final added mass	final_added_mass.js %DEFAU (final_added_percent.js %DEFAULT_DIR%/%%DEFAU
Termination	
	termination.js %DEFAULT_DIR%/%%DEFAULT_JOB%.otf termination

Initial state

Final state

%CURRENT_PAGE%/%%TOTAL_PAGES% Model | %DEFAULT_DIR%

Presentation view after generating report:

Analysis information

Model	
Directory	C:\models\HONDA_ACCORD\ACCORD_56KPH_FFB_DEMO
Filename	ACCORD_56KPH_FFB_001
*TITLE	no title
Hardware/Solver	
Machine	atnode24 (64 CPUs)
Platform	Linux RHEL 5.4 Platform-MPI 8.1.1 Xeon64 uo
LS-DYNA version	mpp s R7.1.2 (95028) Single precision (I4R4)
Computation	
Start time	03/11/2019 17:38:13
End time	03/11/2019 18:55:23
Elapsed time	1 hours 17 min. 10 sec.
CPU time	1 hours 17 minutes 12 seconds
Mass info	
Total mass	0.15023628E+01
Initial added mass	1.3051E-01 (8.7%)
Final added mass	1.3798E-01 (9%)
Termination	
Normal termination	

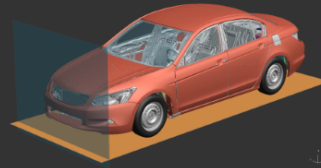

Initial state

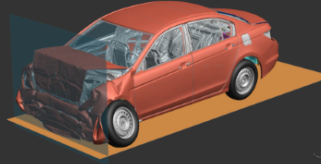

Final state



13.2.1. Using the Cursor in Presentation Mode

Using the cursor in presentation mode

When you first go into presentation mode after generating a template the cursor mode changes to the "hand" cursor. In this mode you cannot select or edit any objects. The cursor is used for following hyperlinks. This is likely to be extended to other functions in future releases of REPORTER .



You can change the mode back to the select mode in which case all of the normal operations which you can do in design mode can be done including editing. Additionally if you choose any of the other modes you can create new objects even though you are in presentation mode.



13.3. Outputting a Generated Report

Outputting a generated report

REPORTER can create various types of output by using the various write option in the **File** menu. Currently the types are:

- [Write Report](#) write the file as a report (images etc included with the template)
- [Write PDF](#) write an Adobe PDF file
- [Write HTML](#) write an HTML web page
- [Write PowerPoint](#) write a Microsoft PowerPoint file directly
- [Print](#) print the report with a printer

The Write options can also be accessed by selecting the appropriate file type from the Save As menu (see below).

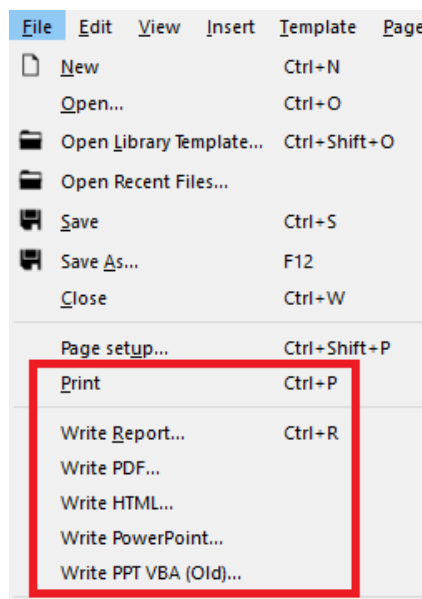



File name:

Save as type: REPORTER Template file (*.ort)

Save as type dropdown menu:

- REPORTER Template file (*.ort)
- REPORTER Report file (*.ort)
- PDF file (*.pdf)
- HTML file (*.html)
- PowerPoint file (*.pptx)
- All files (*.*)

Save Folders



13.3.1. Printing

Printing

On Windows, the **Print** command will bring up the standard windows printer dialog.

On unix, it will bring up the dialog.

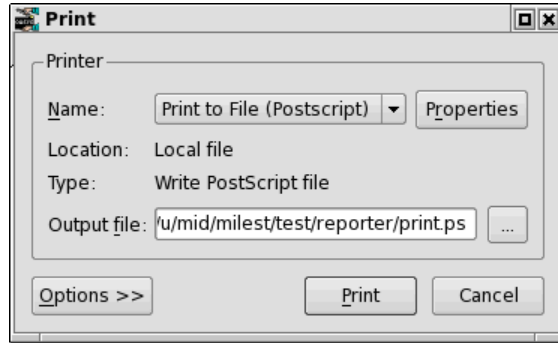

Extra options can be given by pressing the **Options >>** button.

The **Copies** tab allows you to choose what pages should be printed and how many copies.

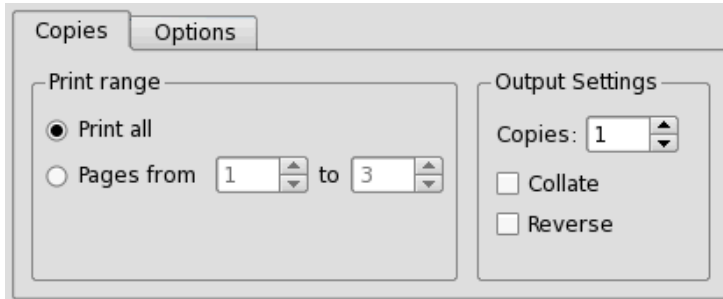

The **Options** tab allows you to choose double sided printing and black and white or colour output.

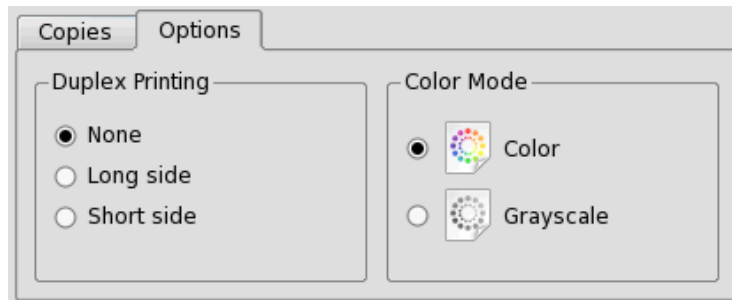

The **Properties** button allows you to set the page size and margins.

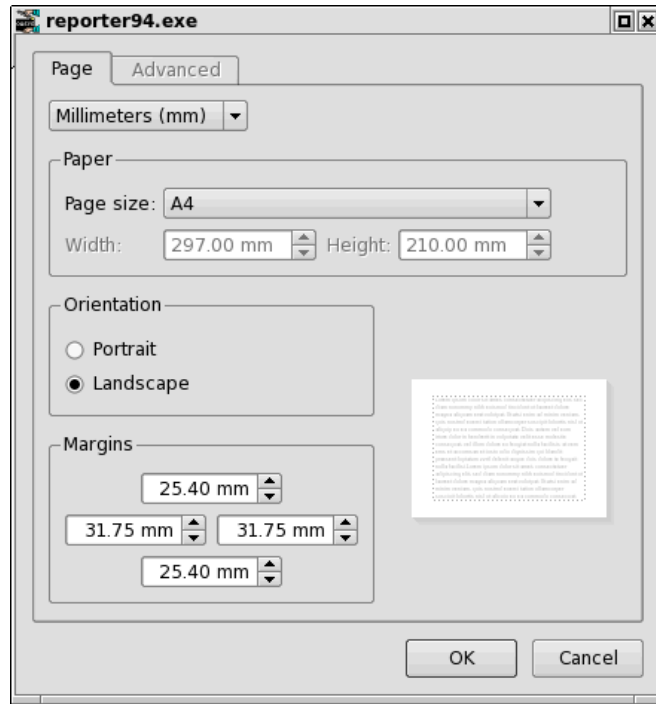



13.3.2. PDF Files

PDF files

Write PDF will save the report as an Adobe PDF file. Select the name of the PDF file you want to write.



13.3.3. HTML Output

HTML output

Write HTML will save the report as a HTML file for the web. Select the name of the HTML file you want to write. REPORTER will then create a HTML page using frames containing the report. There will be a html HTML for each page in the report and a contents page. All the necessary images and files will be placed in a subdirectory of the main HTML file which is called `<name> .html_files` . So for example if you create a file `example.html` , REPORTER will create a directory called `example.html_files` as well and put any extra files in there. So if you want to move the html file to somewhere else remember to move `example.html` and the directory `example.html_files` .



13.3.4. PowerPoint Files

PowerPoint files

Writing PowerPoint files directly

REPORTER can write PowerPoint files directly for Windows and Linux. Select **Write PowerPoint** and give the name of the PowerPoint file you want to create. REPORTER will write the file.

REPORTER can also generate presentations directly using a template to maintain consistent branding or inserting new slides into an existing file. Select **Add to existing PowerPoint file** or tick **Use PowerPoint file as a template** and choose a PowerPoint template to be used.

In batch mode, pair `-pptx` with `-pptx_template` to apply a template, or `-pptx_insert` to add slides to an existing presentation.

Notes on PowerPoint output

When you use [textboxes](#), [text files](#) and [tables](#) in REPORTER the output is clipped to the size of the object defined on the page. PDF and HTML output also support this but it is not possible to control the size of a 'textbox' in PowerPoint (in PowerPoint a table is made up of a collection of 'textboxes'). When writing PowerPoint output be aware of the following limitations.

1. If the text is too wide to fit in the 'textbox' it will automatically be wrapped onto multiple lines by PowerPoint.
2. If the combined height of the text, the top margin and the bottom margin is greater than the height of the textbox PowerPoint will increase the height of the textbox to make it high enough.

If the Powerpoint output is not aligned correctly or is not what you see in REPORTER it is likely to be caused by these problems. Adjusting the size of the object, the text size or the margins will help to fix any problems.

When exporting a template or report containing **GLB** items to PowerPoint, only **GLB** items with the type: **Current frame, Uncompressed** can be viewed in PowerPoint. Any other **GLB** type will not be exported to PowerPoint.



13.4. Combining Output from Multiple Reports

Combining output from multiple reports

If REPORTER generates several templates and saves them as reports (see [Saving a report](#) for more details) then it is sometimes useful to combine the output into a single pdf, html or pptx file. The easiest way to do this is to use the REPORTER options in the SHELL. See the SHELL manual for more details.

It can also be done on the command line in REPORTER by using the `-combine` [command line argument](#). For example, if you wanted to combine the output from 3 reports to a pdf file and a PowerPoint file this could be done with the command:

```
reporter23.exe -combine report1.orr report2.orr report3.orr -pdf=combined.pdf -pptx=combined.pptx -exit
```

13.5. Multimedia Support for Output File Formats

Multimedia support for output file formats

From version 18.0, animation playback has been added to the [D3PLOT](#), [Image](#), and [Image File](#) Items in REPORTER. Currently both animated GIFs and MP4 movies are supported.

From version 20.0, [D3PLOT](#) Items also support the Capture of 3D GLB content from D3PLOT.

The following table provides updated details on the support for different types of multimedia content:

Feature	GIF	MP4	GLB
View in REPORTER	Yes	Yes	Yes ¹
View in Report Viewer	Yes	Yes	Yes
Export to PowerPoint	Yes	Yes	Yes ²
Embed in Templates (.ortx) and Reports (.orr)	Yes	Yes	Yes
Embed in [LEGACY] Templates (.ort) and Reports (.orr)	Yes	No	No
Export to PDF or HTML	No ³	No ³	No ³

¹ GLB content in REPORTER will be rendered as a static thumbnail image, but is fully viewable in Report/D3PLOT Viewer.



² Only the GLB (Current frame, Uncompressed) option is suitable for export to PowerPoint. Exporting other GLB types to PowerPoint will not work!

³ GIFs, MP4 movies, and 3D GLB content will all appear as static images in PDF and HTML.



14. Working with Variables

Working with Variables

A main feature of REPORTER is that you create a template from which a report can be generated. This allows you to create a standard template for a project and then use that template to automatically create a report for a number of model runs. This is mainly achieved through the use of variables.

Variables are defined with a name and a value which can be a number or a text string, for example.

Variable Name	Value
CURRENT_PAGE	2
DEFAULT_DIR	/data/test/ tube1
DEFAULT_JOB	tube_test1

The main advantage of using variables when defining the various objects in the report template is that rather than having to go through the report and change all the various filenames and directory paths when you want to generate a report from a new model, all you need to do is change the variables. This can be done manually by editing the template in REPORTER , or you could insert a program/script into the template that would calculate and define all the necessary variables when REPORTER generates a report.

14.1. User Defined Variables

User defined variables

For example, if you want to create a report template that has a number of images that are created by a D3PLOT object. If you want to use the template to generate reports for a number of models, the problem is that the various filenames and directory paths will be different for each model. e.g:

Model	Directory Path	Job Name
Crush Tube 1	/data/test/tube1	tube_test1
Crush Tube 2	/data/test/tube2	tube_test2
Crush Tube 3	/data/test/tube3	tube_test3

To get round this problem you can use a variable for the directory path called `DEFAULT_DIR` and a variable for the job name called `DEFAULT_JOB` . When inserting the D3PLOT objects (see [D3PLOT Objects](#) for more detail about inserting D3PLOT



objects) use the variables for the directory path and job name. The variables need to be enclosed by % signs to distinguish them from the rest of the text string.

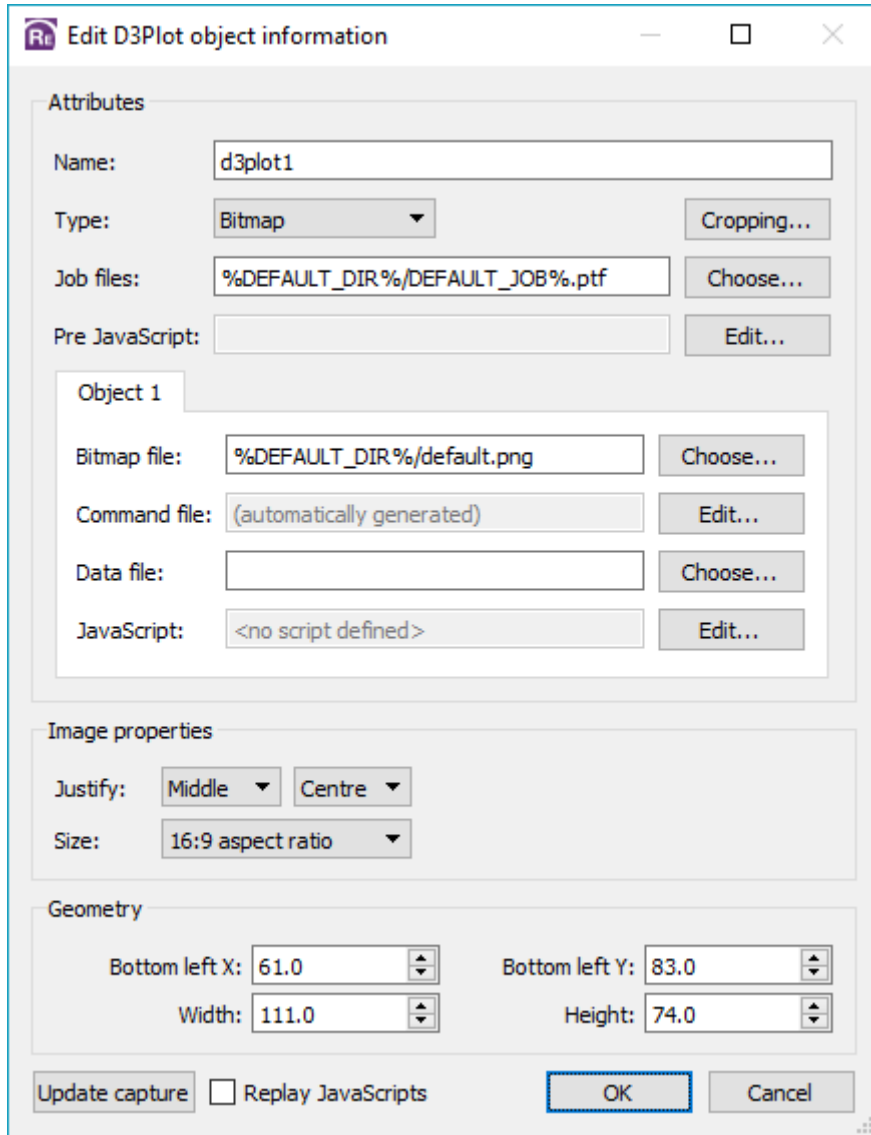

When generating a report for Crush Tube 2 model, the variables would be defined as follows:

Variable Name	Value
DEFAULT_DIR	/data/test/tube2
DEFAULT_JOB	tube_test2

When REPORTER generates the report it will substitute in the values of the relevant variables, so the two text strings would become:

Bitmap File	/data/test/tube2/def.bmp
Job File	/data/test/tube2/tube_test2.ptf



To generate a report for one of the other templates, all you need to do is change the value of `DEFAULT_DIR` and `DEFAULT_JOB`.

14.2. Predefined Variables

Predefined variables

REPORTER already has a number of variables defined. They are:

Variable	Description
<code>CURRENT_PAGE</code>	The current page in the report (can be used when a report is generated)
<code>TIME</code>	The current time (can be used when a report is generated)
<code>DATE</code>	The current date (can be used when a report is generated)
<code>DEFAULT_DIR</code>	A default directory for a job
<code>DEFAULT_JOB</code>	A default jobname
<code>REPORTER_HOME</code>	The directory REPORTER is installed in
<code>REPORTER_TEMP</code>	A temporary working directory
<code>TOTAL_PAGES</code>	The total number of pages (can be used when a report is generated)
<code>TEMPLATE_DIR</code>	The template directory (useful for locating files relative to the current template)

14.3. Formatting TIME and DATE Variables

Formatting TIME and DATE variables

To add the date to each page you can insert a text object (see [Text](#) for more detail on text objects) with the relevant variables substituted in (e.g. see the image below).

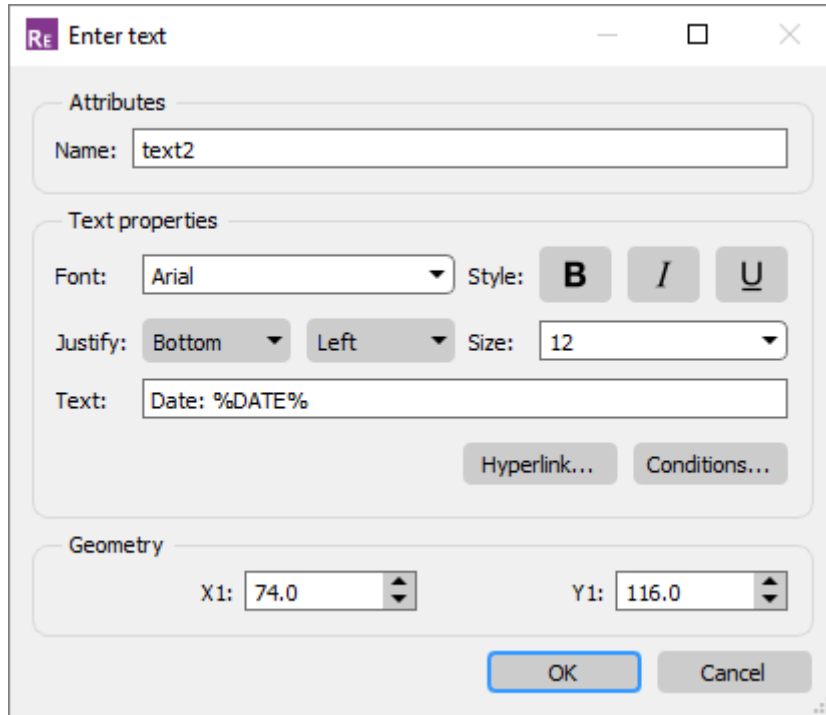

The default formatting for the date variable is such that if the day were Saturday 1st February 2020, %DATE% would be generated as Sat Feb 1 2020.

For the time variable, if it were 56 seconds past the 34th minute of the 12th hour of the day then %TIME% would be generated as 12:34:56.

Formatting can be changed for individual instances of the %DATE% and %TIME% variables by using bracketed arguments. For example, %DATE(ddd MMM d yyyy)% provides the default formatting described above. Other options are given in the tables below. Any input characters not included in these tables will be treated as regular text. This allows for further formatting customisation (e.g. %DATE(ddd-MMM/d.yyyy)% for Sat-Feb/1.2020).

For the %DATE% variable, formatting expressions and output are as follows:

Expression	Output
d	The day as a number without a leading zero (1 to 31)
dd	The day as a number with a leading zero (01 to 31)
ddd	The abbreviated localised day name (e.g. 'Mon' to 'Sun')
dddd	The full localised day name (e.g. 'Monday' to 'Sunday')
M	The month as a number without a leading zero (1 to 12)
MM	The month as a number with a leading zero (01 to 12)
MMM	The abbreviated localised month name (e.g. 'Jan' to 'Dec')



MMMM	The full localised month name (e.g. 'January' to 'December')
yy	The year as a two digit number (00 to 99)
yyyy	The year as a four digit number

Similarly, for the %TIME% variable:

Expression	Output
h	The hour without a leading zero (0 to 23 or 1 to 12 if AM/PM)
hh	The hour with a leading zero (00 to 23 or 01 to 12 if AM/PM)
H	The hour without a leading zero (0 to 23, even with AM/PM)
HH	The hour with a leading zero (00 to 23, even with AM/PM)
m	The minute without a leading zero (0 to 59)
mm	The minute with a leading zero (00 to 59)
s	The second without a leading zero (0 to 59)
ss	The second with a leading zero (00 to 59)
z	The millisecond without a leading zero (0 to 999)
zzz	The millisecond with a leading zero (000 to 999)
AP or A	Interpret as an AM/PM time. 'AP' must be either 'AM' or 'PM'
ap or a	Interpret as an AM/PM time. 'ap' must be either 'am' or 'pm'

14.4. Creating and Editing Variables

Creating and editing variables

Variables can be viewed, edited, and created by using the [Edit...](#) option in the [Variables](#) menu. Selecting this option will bring up the [Variables](#) window.

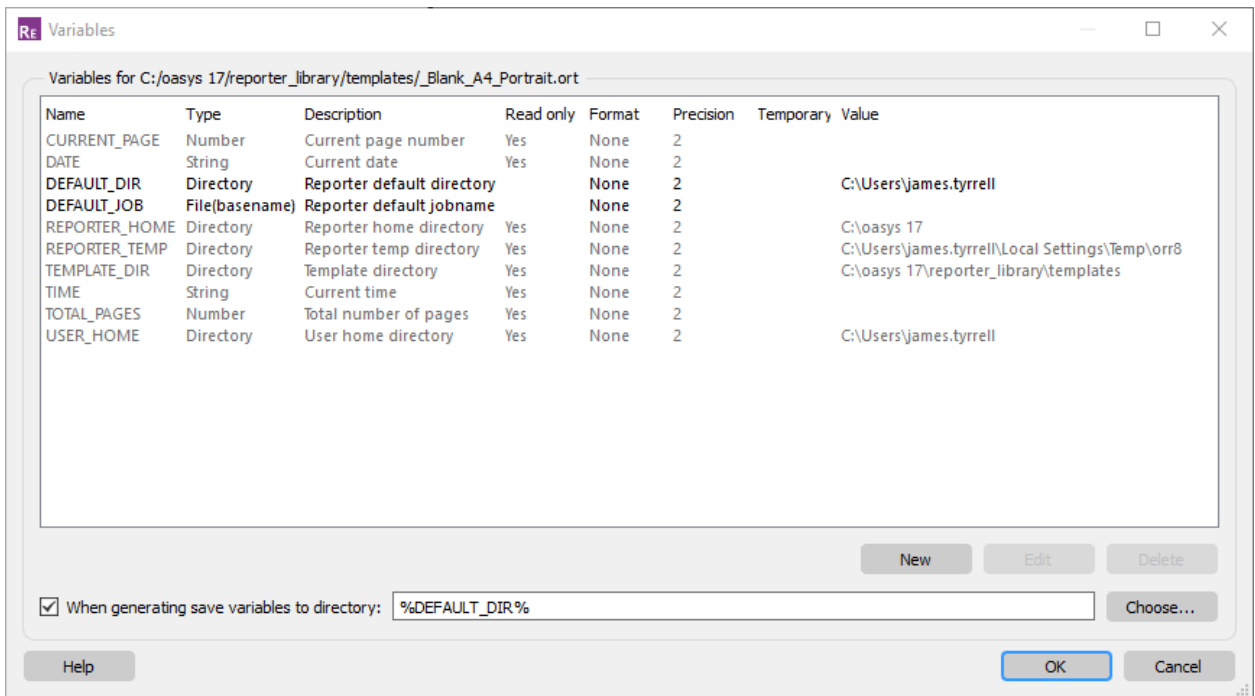

Some of the variable such as **CURRENT_PAGE** and **REPORTER_HOME** are [predefined variables](#) that are predefined by REPORTER . and these cannot be edited or deleted, other user defined variables can be edited or deleted as you chose.

You can create a new variable by selecting **New** . Then in the **New variable** box at the bottom of the window enter the necessary details into the text boxes.

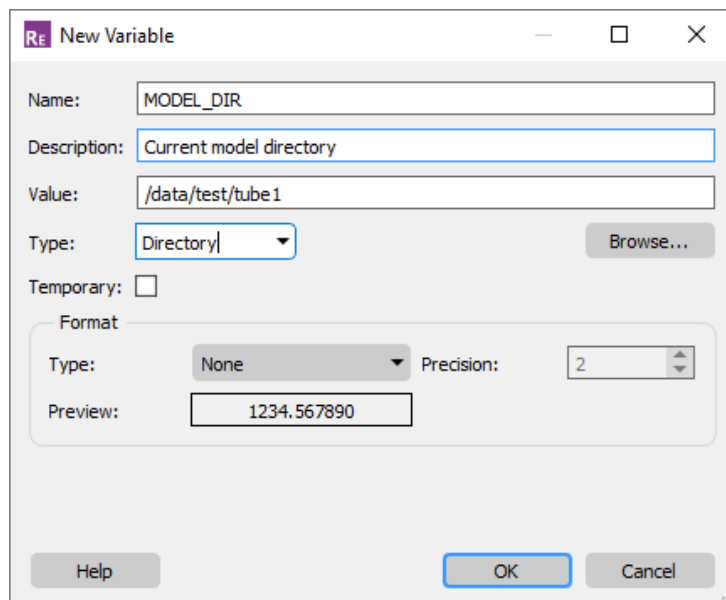

- **Name** - enter the variable name you want to use to refer to this variable. Variable names should only use letter (A-Z) or numbers (0-9) and underscores. REPORTER will automatically convert the name into uppercase and replace any spaces with underscores when the new variable is created.



- **Description** - enter the description for the variable. This is only for reference and is not actually used by REPORTER . However, it is strongly recommended that you give meaningful descriptions for variables.
- **Value** - enter the value for the variable. This can be any text string or number you want.
- **Type** - the variable type allows you to give an indication what the variable will be used for. The following types are predefined in REPORTER .
 - Directory
 - Expression
 - File(absolute)
 - File(basename)
 - File(extension)
 - File(tail)
 - General
 - Number
 - String

Additionally you can give your own variable types if it helps you to manage variables.

The `Directory` and `File` types also allow you to choose a directory/file interactively using the **Browse...** button. The different `File` types allow you to extract certain parts of the filename from the file you choose. For example selecting a file `'/data/demo/test.key'` by using **Browse...** would result in the following:

Variable type	Part of file that is extracted
File(absolute)	/data/demo/test.key
File(basename)	test
File(extension)	key
File(tail)	test.key

- **Temporary** - tick the box if the variable should be temporary or not. This makes no difference to how the variable is used in REPORTER , however for convenience temporary variables can be removed from the template at any point by using the **Delete temporary variables** option in the **Variables** menu.
- **Format** - the format settings allow you to specify how the variable value is displayed within the REPORTER presentation view. Available options are:
 - Floating point number - displays a number variable as a floating point number. The number of decimal places can be specified using the precision setting.
 - Scientific number - displays a number variable as a scientific number. The number of decimal places can be specified using the precision setting.
 - General number - this uses the shorter of the floating point or scientific methods above..
 - Integer - displays a number variable as an integer.
 - Uppercase - displays a string type variable in uppercase.
 - Lowercase - displays a string type variable in lowercase.



The setting used here is applied to everywhere the variable is displayed in the report, unless a [local format setting](#) is used. The format setting does not change the underlying value of the variable.

You then click on the **OK** button to store this new variable. The **Cancel** button will just exit you from this window.

The only variables which can be edited are the user defined ones you create yourself. To edit a variable select the **Variable** option in the **File** menu to bring up the **Variables** window. You can edit the description or value of a variable by clicking on the relevant description or value in the variable list and pressing **Edit**. You cannot edit the variable name. If you want to rename the variable you will have to delete the existing variable and re-create it using the new name.

For more information on doing simple maths with variables (by using the expression type) see [Variable expressions](#).



14.5. Creating a Variable Using D3PLOT

Creating a variable using D3PLOT

The **Objects** floating menu allows you to define values to be returned to REPORTER as variables by pressing the **Variables** button (see [Using capture to create a D3PLOT object](#)), which launches the **Variables** floating menu. Variables are limited to the maximum and minimum values displayed on the lefthand side of the D3PLOT window with the corresponding entity type and entity id as additional variables that can be selected if required. Note that variables will only be available for selection in this panel if max/min values are set to be shown in the Data Panel and the plot is a data plot.

To create a variable first select the window containing the required value using the drop-down menu, then select the correct model using the drop-down menu. The variable type can be selected from the **Variable Type** drop-down menu. Default names and descriptions are then created for the value variable and the corresponding entity id and entity type variables. By default the entity id and entity type variables are not exported to REPORTER. To export them tick the appropriate box. The variable names and descriptions can be edited and the variable name can also be selected using the drop-down menu, which contains a list of the user-defined variables in REPORTER.

You should note that although the variables menu will prevent variable names being duplicated within a single D3PLOT session, care should be taken to avoid duplicating variable names across more than one D3PLOT session as REPORTER will only hold a single value for each variable name.

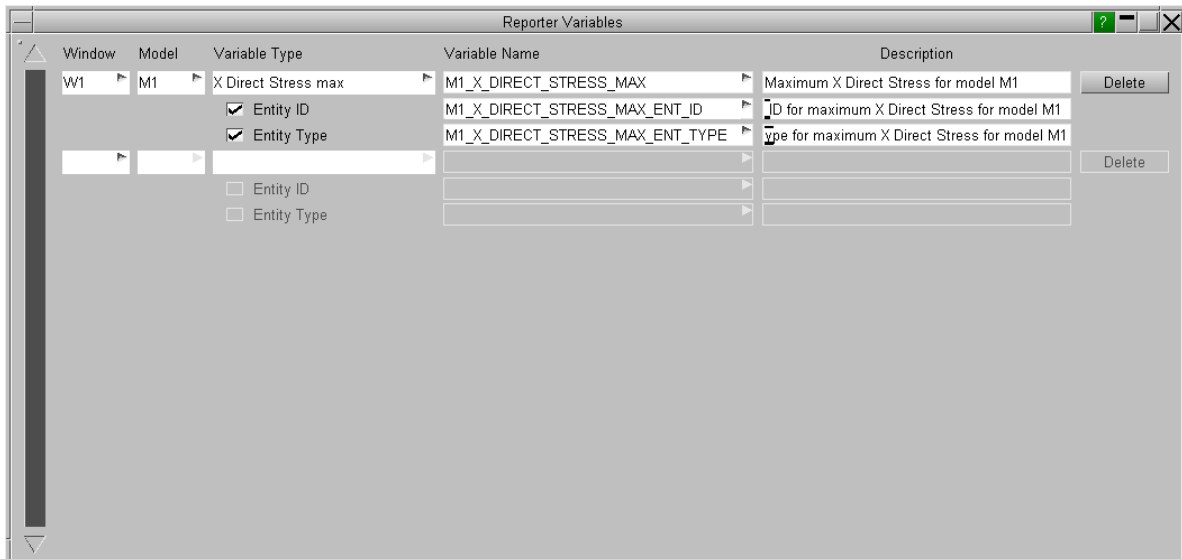



14.6. Creating a Variable Using T/HIS

Creating a variable using T/HIS

The Variables menu can be launched by pressing the button within the FASTTCF Script menu in T/HIS.

In the Variables menu variables can be defined interactively. These variables are exported to REPORTER on exit from a T/HIS REPORTER session.

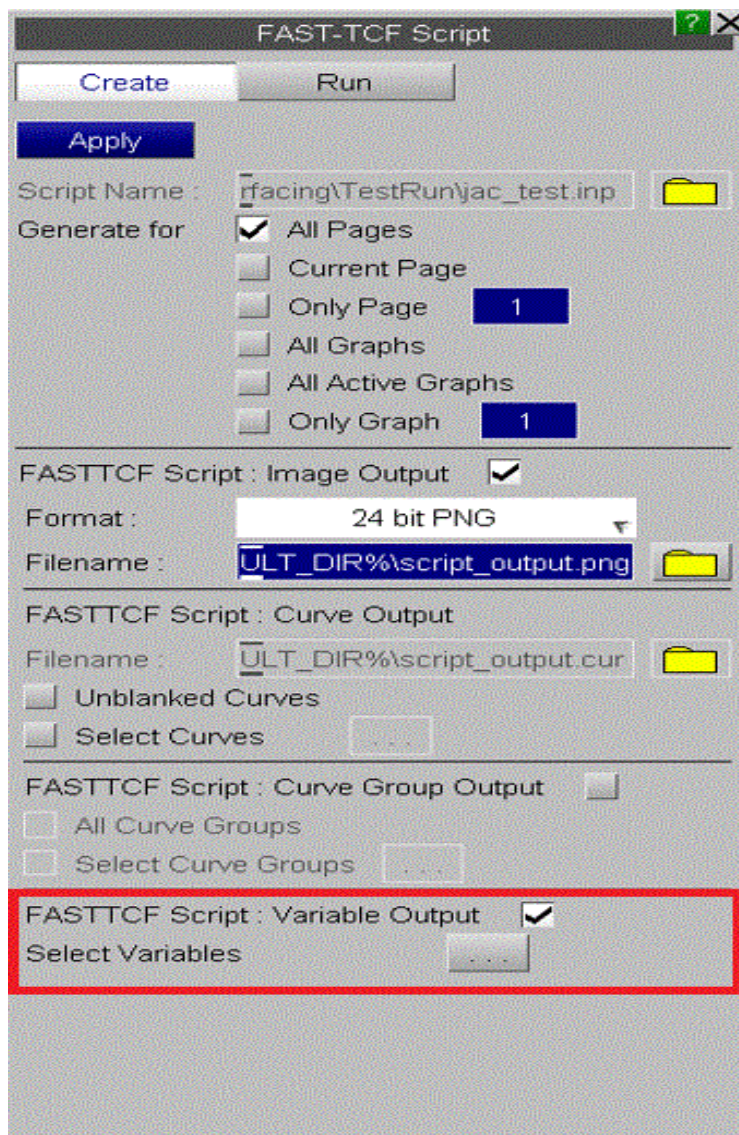

Variable Output or **Tabular Output** are selected at the top of the menu. Each output request is defined on a row of the table. The curve and variable type are selected using the drop down menu. A default variable name is generated and can be manually edited or a name can be selected from variable names that are present in . Additional value fields are populated with default values if required and these can be edited. The output description is also populated with default text that can be edited. The output type is



selected using the drop down menu. Curve Lock prevents the curve that the variable refers to from being deleted. If a curve is not locked and is deleted, then any variables associated with that curve will also be deleted.

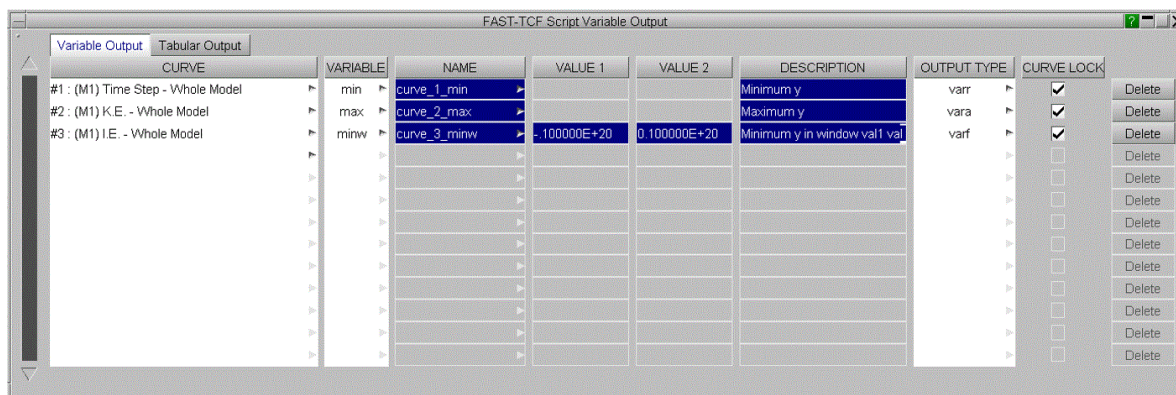

14.7. Creating a Variable Using an External Program/Script

Creating a variable using an external program/script

Rather than using the **Variables** window to create and define a variable it is also possible to use a program/script to create a variable. (See [Appendix D](#) for some examples of programs/scripts)

When REPORTER generates a report and it runs an external program/script, any output lines that take the form

```
VAR <NAME> VALUE="<value>" DESCRIPTION="<description>"
```

or

```
VAR <NAME> VALUE="<value>"
```

will not be inserted into the report as text but will be used to create a variable where

- **<NAME>** - will become the variable name
- **<value>** - will become the value of the variable
- **<description>** - will become the variable description

here are a couple of examples

Program/Script Output	Variable Name	Description	Value
VAR DEFAULT_DIR VALUE="/data/test"	DEFAULT_DIR	(none)	/data/test



VAR SPEED VALUE="1000" DESCRIPTION="Impact Speed"	SPEED	Impact speed	1000
--	-------	-----------------	------

So if you inserted a program/script object "Text output from a program/script" (see [Program objects](#) for more detail on inserting program/script objects) that's output was

```
VAR SPEED VALUE="1000"
```

then REPORTER would create a variable called `SPEED` with the value 1000, and because there is no other output then the inserted text object would come up blank when the report was generated. If the output however was

```
VAR SPEED VALUE="1000"  
Impact Speed: %SPEED%
```

then REPORTER would create a variable called `SPEED` with the value 1000, and also create the following text object with the new variable `SPEED` substituted in.

```
Impact Speed: 1000
```

By default any variables that you read from an external program/script will be marked as "temporary". If you do not want the variable to be temporary then the variable name can appended with '!' and this will tell REPORTER not to mark it as temporary. Alternatively '#' can be used to mark the variable as temporary (although this is not needed as it is the default). For example the following two lines would both mark the variable `SPEED` as temporary (the default)

```
VAR SPEED VALUE="1000"  
VAR SPEED# VALUE="1000"
```

The following line would mark the variable `SPEED` as **not** being temporary.

```
VAR SPEED! VALUE="1000"
```

14.8. Creating a Variable Using a FAST-TCF Script

Creating a variable using a FAST-TCF script

Rather than using the [Variables](#) window to create and define a variable it is also possible for a FAST-TCF script to create and define variables. You can create a variable in FAST-TCF from one of the following curve results. (See the FAST-TCF section of the T/HIS manual for more details)

Property output	keyword
Minimum x	minx
Maximum x	maxx
Minimum y	min



X at minimum y	xatmin
Y at minimum x	yatmin
Minimum y in window t1 t2	minw
X at minimum y in window t1 t2	xminw
Maximum y	max
X at maximum y	xatmax
Y at maximum x	yatmax
Maximum y in window t1 t2	maxw
X at maximum y in window t1 t2	xmaxw
Average in window t1 t2	ave
Hic	hic
Hicd	hicd
3ms	3ms
Y at X	yatx
X when Y is passed after gate time	xygate
X at first non-zero Y	xnonz
X at last non-zero Y	xfail
Y value at last non-zero Y	yfail
TTI	tti

The values for these results need to have already been calculated in the script before you use them to create a variable. The syntax to create a variable takes one of these two forms:

```
var <NAME> <curve> <result> <description>
```

or

```
var <NAME> <curve> <result>
```

- **<NAME>** - will become the variable name
- **<curve>** - is the curve tag or number
- **<result>** - is the result type (min,max,ave,hic,hicd,3ms)
- **<description>** - will become the variable description

REPORTER will set the value of the variable to be the value of the result type for the specified curve. Here are a couple of examples

FAST-TCF data			REPORTER data		
FAST-TCF script	Curve No.	Value of the result (Result Type)	Variable Name	Description	Value
var DEFORM 1 ave	1	20 (ave)	DEFORM	(none)	20
var SPEED 2 max Impact Speed	2	1000 (max)	SPEED	Impact speed	1000



The variable defined in REPORTER will be marked as temporary.

14.9. Creating a Variable from the Command Line

Creating a variable from the command line

Variables can be defined in REPORTER when starting from the command line with the `-var` option. For example to define variable `DEFAULT_DIR` you could do:

```
reporter 23.exe -varDEFAULT_DIR=/data/test/tube1
```

If the variable contains spaces then it must be quoted.

```
reporter 23.exe -varDEFAULT_DIR="C:\directory with spaces\tube1"
```

By default variables defined on the command line will not be temporary. You can change this and also specify the variable type on the command line if required. For more details see [appendix A](#).

14.10. Creating a Variable from Javascript

Creating a Variable from JavaScript

You can create variables from JavaScript scripts in REPORTER with the Variable constructor. For example

Copy Code

JavaScript

```
var fred = new Variable(reporter.currentTemplate, "DEFAULT_DIR",  
"current model directory", "/data/test1");
```

By default any variable that is made will be marked as temporary but this can be changed. For more details see the Variable class in the JavaScript reference manual.



14.11. Deleting Variables

14.11.1. Deleting a Variable

Deleting a variable

You can delete an user defined variable in the **Variables** window by clicking on the **Delete** button when the relevant variable is selected. Please note that this will delete the variable from the list without bringing up any conformation box. However the variable will not be deleted until **OK** is pressed in the main variables menu.

Predefined variables cannot be deleted.

14.11.2. Deleting all Temporary Variables

Deleting all temporary variables

Any temporary variables can be deleted by using the **Delete temporary variables** command in the **Variables** menu. Please note that this will delete the temporary variables without any confirmation.

14.12. Inserting a Variable

Inserting a variable



Certain inputs for such things as filenames, text, and program/script arguments can use variables rather than a straight text string. You can insert a variable at the current cursor position by right clicking on the text box

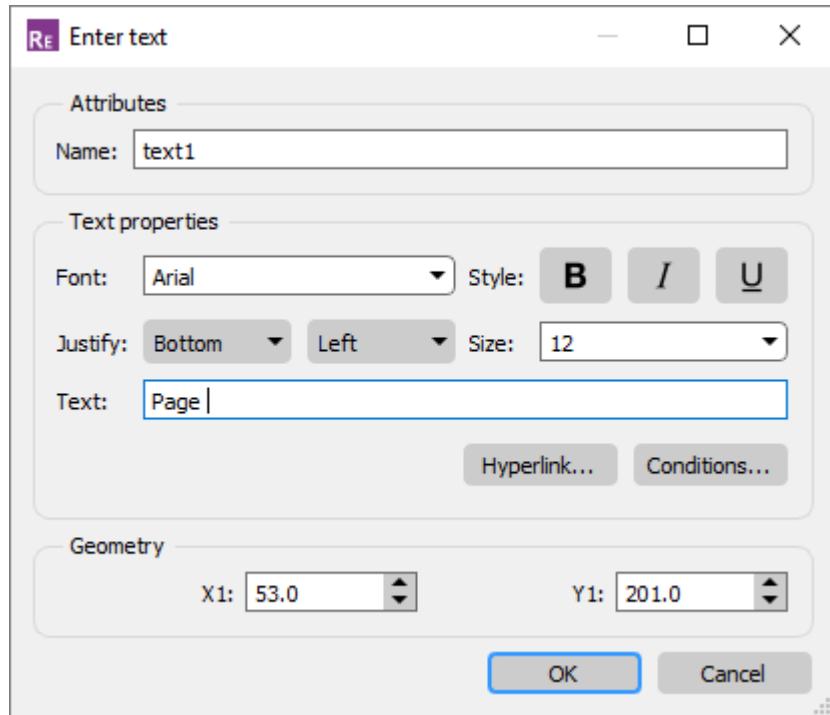

From the popup menu select **Insert variable**.

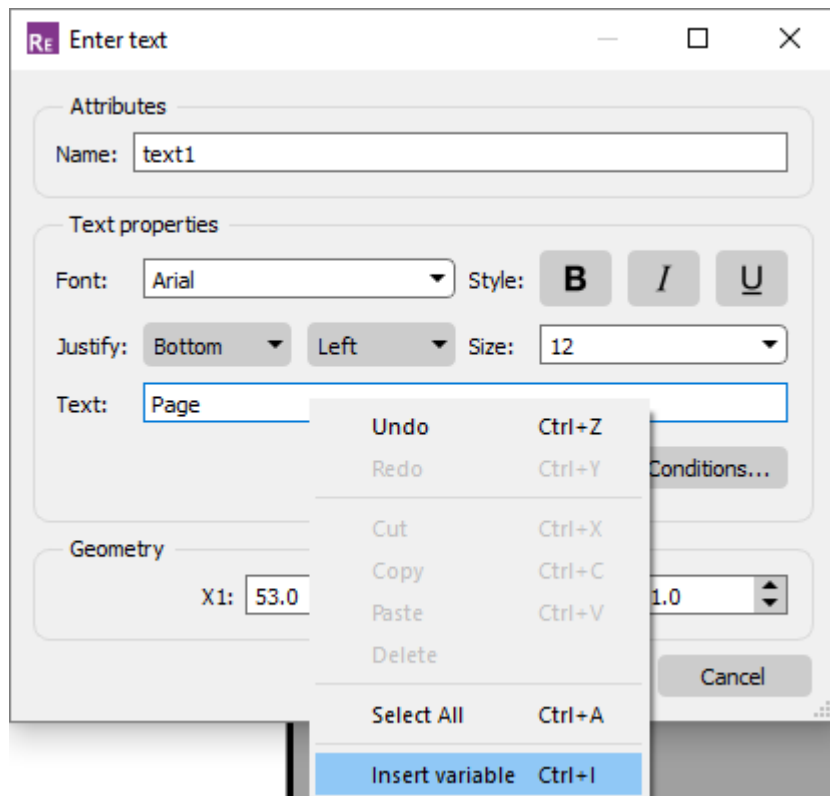

An **Insert variable** window from which you can select the variable will then be brought up.

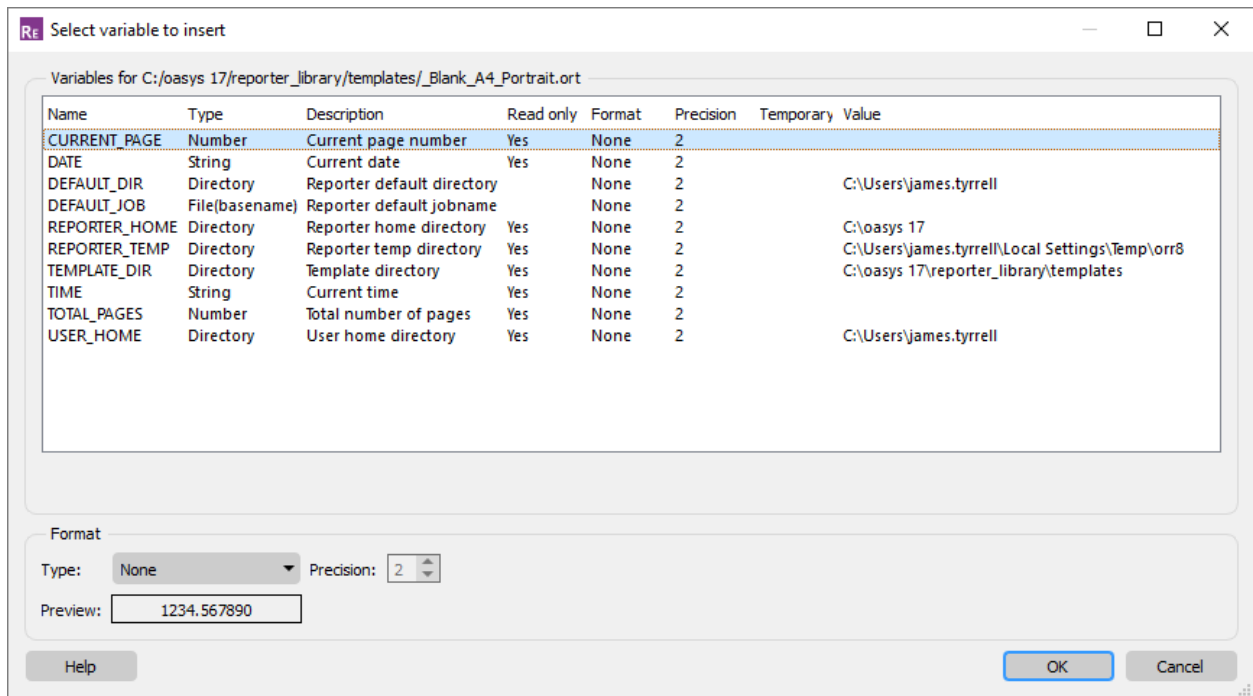

From this window you select the variable you want from the list and click on the **OK** button to insert the variable and exit this window. The **Cancel** button will exit this window with out inserting a variable.

Note in this panel you can set a local format setting for the variable. This is a format that is applied to this instance of variable when viewed in presentation model. The available options are:

- Floating point number - displays a number variable as a floating point number. The number of decimal places can be specified using the precision setting.
- Scientific number - displays a number variable as a scientific number. The number of decimal places can be specified using the precision setting.
- General number - this uses the shorter of the floating point or scientific methods above..
- Integer - displays a number variable as an integer.
- Uppercase - displays a string type variable in uppercase.
- Lowercase - displays a string type variable in lowercase.

This local format setting overrides any global format setting for this variable specified on the main variables panel. However, the format set here is only applied to this instance of the variable.

When entered into a text string the variable needs to be enclosed by % signs put at either end of the variable name to distinguish it from the rest of the text string. In this example the variable `CURRENT_PAGE` has appeared in the text box as `%CURRENT_PAGE%` .



14.12.1. Manually Inserting a Variable

Manually inserting a variable

It is also possible for you to manually enter a variable in by simply typing in the variable name enclosed by % signs. When the report is generated the **%CURRENT PAGE%** part of the text string will be replaced with the value of the variable. If a local format is set, this will be displayed within the % signs.



14.12.2. Controlling the Precision/Decimal Places of a Variable

Controlling the precision/decimal places of a variable

The precision of a variable can be set in the [Insert variable](#) window when inserting it. See the section above on [variable format](#). Alternatively the precision can be set when typing in the variable.

For example, for a variable called **ACCELERATION**, if a local format of a two decimal place floating point number is specified, the variable **ACCELERATION** will appear as **ACCELERATION(2f)** %. When generated, this will appear as the formatted value. A complete list of the formats is available in the table below.

Format	Example	Input string	Output string
Fixed	%NAME(2f)%	1234.5678 12.345678	1234.56 12.35
Exponential / scientific	%NAME(2e)%	1234.5678 12.345678	1.23e+03 1.23e+01
General. uses exponential format or fixed format (whichever is the most concise)	%NAME(2g)%	1234.5678 12.345678	1.23e+03 12
Integer	%NAME(i)%	1234.5678 12.345678	1235 12
Lower case	%NAME(s)%		reporter
Upper case	%NAME(S)%		REPORTER

14.13. Using Variables in D3PLOT and T/HIS Command Files and FAST-TCF Scripts

Using variables in D3PLOT and T/HIS command files and FAST-TCF scripts.

It is also possible to use variables in a D3PLOT or T/HIS command file or FAST-TCF script that is referred to by a D3PLOT or T/HIS object inserted in the template (see [D3PLOT Objects](#) for more details on inserting D3PLOT and T/HIS objects).



14.13.1. Command Files

Command files

For a command file you will need to first create the command file using an actual value for the variable and then manually edit the command file to replace this value with the variable name enclosed in % signs.

Example

For example, if you have a simple T/HIS command file that reads in a THF file, creates a curve of x displacement for node 30, and then creates a bitmap image of the curve.

READ	31	3	2	3	0	0	0	0
THF	32	3	2	11	0	0	0	0
cube5.thf	4	3	6	5	0	0	0	0
Nodes	4	3	2	12	0	0	0	0
Node 30	3	4	3	14	0	0	0	0
APPLY	5	3	2	2	0	0	0	0
PLOT	1	3	2	1	0	0	0	0
IMAGES	31	3	2	15	0	0	0	0
cube5.bmp	38	3	6	12	0	0	0	0
CAPTURE	38	3	2	25	0	0	0	0

If you want to use the variable **DEFAULT_JOB** for the filenames instead of cube5, and the variable **NODE** instead of the node number 30. manually edit the command file to give the following. (Note that the position of the numbers on the right hand side should not be modified)

READ	31	3	2	3	0	0	0	0
THF	32	3	2	11	0	0	0	0
%DEFAULT_JOB%.thf	4	3	6	5	0	0	0	0
Nodes	4	3	2	12	0	0	0	0
Node %NODE%	3	4	3	14	0	0	0	0
APPLY	5	3	2	2	0	0	0	0
PLOT	1	3	2	1	0	0	0	0
IMAGES	31	3	2	15	0	0	0	0
%DEFAULT_JOB%.bmp	38	3	6	12	0	0	0	0
CAPTURE	38	3	2	25	0	0	0	0



14.13.2. FAST-TCF Scripts

FAST-TCF scripts

For a FAST-TCF script when you enter the script you need to replace the relevant parts with the variable name enclosed in % signs

Example

For example, a simple FAST-TCF script that will do the same thing as the T/HIS command file above.

```
node 30 disp x tag XDISP  
bitmap cube5.bmp XDISP
```

So to make the same changes as the T/HIS command file above (substituting in the variables **DEFAULT_JOB** and **NODE**) gives the following.

```
Node%NODE% disp x tag XDISP  
bitmap %DEFAULT_JOB%.bmp XDISP
```

14.14. Saving all the Variables to a File After Generating a Report

Saving all the variables to a file after generating a report

After REPORTER generates a report, it can automatically save any variables to a file. The file will be called **reporter_variables** . This can be very useful for processing multiple analyses. For example, you could perform several analyses which all dump their variables to a file, and then a summary template could create a table using these files (see [Table Objects](#) for more details).

At the bottom of the variables window there is a checkbox to turn on this option. You can then give a directory to save the variables into.

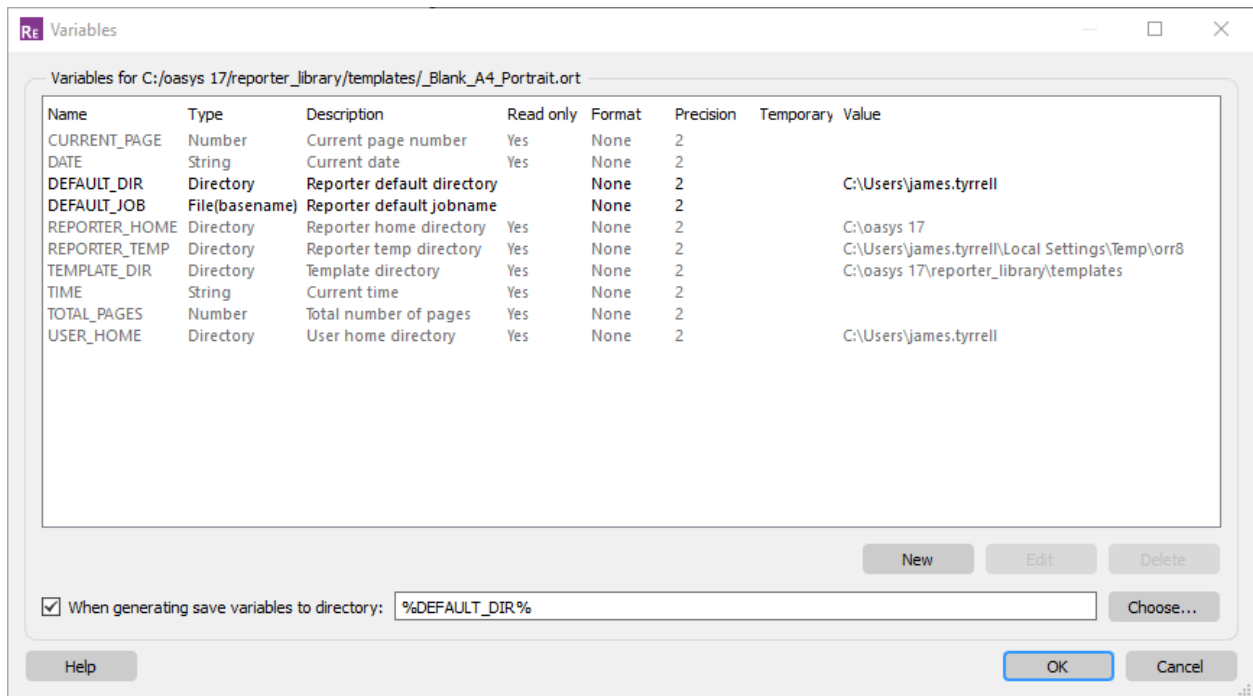

You can select the directory or use a variable if required. The directory defaults to `%DEFAULT_DIR%` and is off by default.

14.15. Variable Expressions

Variable expressions

Sometimes it is useful to do some simple maths on variables in REPORTER . Creating a script to do something this simple is tedious. If you use the **Expression** variable type then REPORTER will evaluate this when required to produce the result. For example assume that you have 2 variables, `FORCE` and `AREA` and you want to calculate a stress. You can do this by:

1. Make a new variable `STRESS` .
2. Set the type to **Expression** .
3. Give the value `%FORCE%/%AREA%` (see [Creating and editing variables](#) for more details) by either typing directly or using the right mouse button and Inserting variables with the menu.

Then if you have some text in the report such as "The stress is `%STRESS%`" REPORTER will evaluate the stress as required.

The expression can contain `+`, `-`, `/` and `*` to do addition, subtraction, division and multiplication respectively and can use brackets to enforce which order the expression is evaluated in. The expression is actually evaluated as a JavaScript program so more



complex expressions can be formed by using the standard JavaScript functions (e.g. the Math class). e.g. the following are all valid expressions

- `%FORCE%/%AREA%`
- `Math.sqrt(%X%*%X% + %Y%*%Y%)`
- `Math.min(%X%, %Y%) * Math.sin(Math.PI)`



14.15.1. Rounding Values in Variable Expressions

Rounding values in variable expressions

As the expression is evaluated as a JavaScript program (see the previous section) we can use some of the core functions in JavaScript to alter the variable value. For example, in our example of calculating a variable STRESS from an expression `%FORCE%/ %AREA%` this could have a large number of significant figures in the result.

E.g. if `FORCE=10` and `AREA=3` then stress is `3.33333333333333` which is far more significant figures than we require.

We can use the core JavaScript function `toFixed()` to change the number of digits to appear after the decimal point. If we wanted 2 decimal places then we could change the expression to

```
(%FORCE% / %AREA%).toFixed(2)
```

which would change the value of STRESS to 3.33.

Other useful functions are:

- `toExponential(n)` which formats the number in exponential (scientific) notation with `n` digits after the decimal point.
- `toPrecision(n)` which formats the number with `n` significant figures.



15. Hyperlinks

Hyperlinks

REPORTER currently allows you to create hyperlinks from the following object types

- Text objects
- Image objects
- Table cells
- D3PLOT images with external data plots ('blob' plots).

15.1. Adding Basic Hyperlinks

Adding basic hyperlinks

Objects that support hyperlinks will have a **Hyperlink...** button. Pressing it maps the hyperlink window.

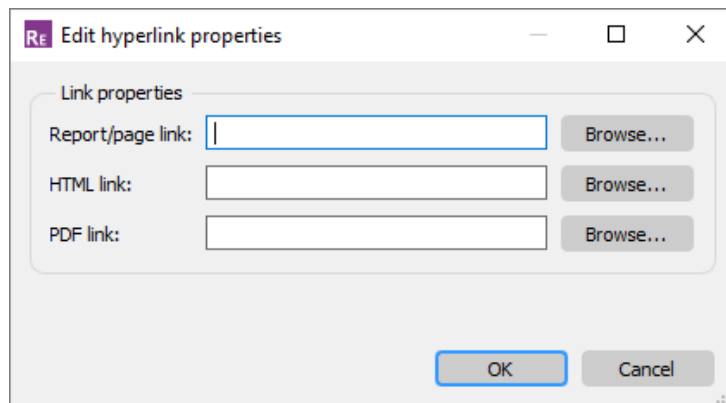

REPORTER can write HTML and pdf and can also save a generated report. As all of these formats support hyperlinks you cannot give a single hyperlink that will work for all of the formats. For this reason REPORTER allows you to give different links for each type. For example in the image below the link is different for each type. If you do not want links for a particular type then leave it blank.

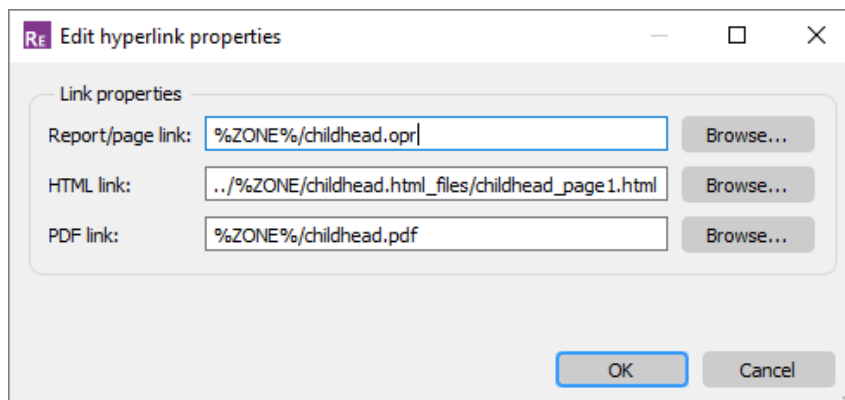



Hyperlinks can be relative or absolute (if you use a relative hyperlink then it is relative to the current document).

15.2. Adding Hyperlinks in D3PLOT External Data (Blob) Plots

Adding hyperlinks in D3PLOT external data (blob) plots

The data file which D3PLOT uses to create blob plots supports hyperlinks. This enables the user to be able to click on one of the data values on the image and open the report for that data point. The easiest way to create a data file for D3PLOT is with one of the D3PLOT data file library scripts. e.g. below shows the script for generating a data file from `reporter_variables` files.

Choose Library Program

Attributes

Name:

Program:

- ▼ D3Plot data file
 - Create a D3Plot data file from a csv file
 - Create a D3Plot data file from generated variables files
- > Errors
- > Keyword file
- > NCAP
- > OTF file
- > Pedestrian
- > Variables

Arguments:

	Description	Value
7	Link for reporter files (false = no link)	%ZONE%/childhead.opr
8	Link for html files (false = no link)	%ZONE%/childhead.html
9	Link for pdf files (false = no link)	%ZONE%/childhead.pdf

Output

Set to variable:

Do not show any output on page

Text properties

Style: **B** *I* U Justify:

Font: Size:

Geometry

Bottom left X: Bottom left Y:

Width: Height:

Arguments 7, 8 and 9 allow you to give your hyperlinks in exactly the same way as a basic hyperlink.



16. Conditional Formatting

Conditional formatting

Conditional formatting can be used in REPORTER to change how text is displayed, depending on if a specific condition has been met. This is very similar to the conditional formatting in Microsoft Excel, but REPORTER can use as many conditions as you wish per object instead of the limit of 3 imposed by Excel.

Conditional formatting is currently supported for the following object types:

- Text
- Programs/scripts returning text
- Text files
- Table cells
- Text boxes

For example you may want to change the colour of a number in a report depending on the value.

Red if the value is greater than 100

Blue if the number is between 50 and 100

Green if the number is less than 50

This is very easy to do in REPORTER.

16.1. Adding a Condition

11.1. Adding a condition

To add a condition for an object, press the **Condition** button. This will start the conditional formatting window.

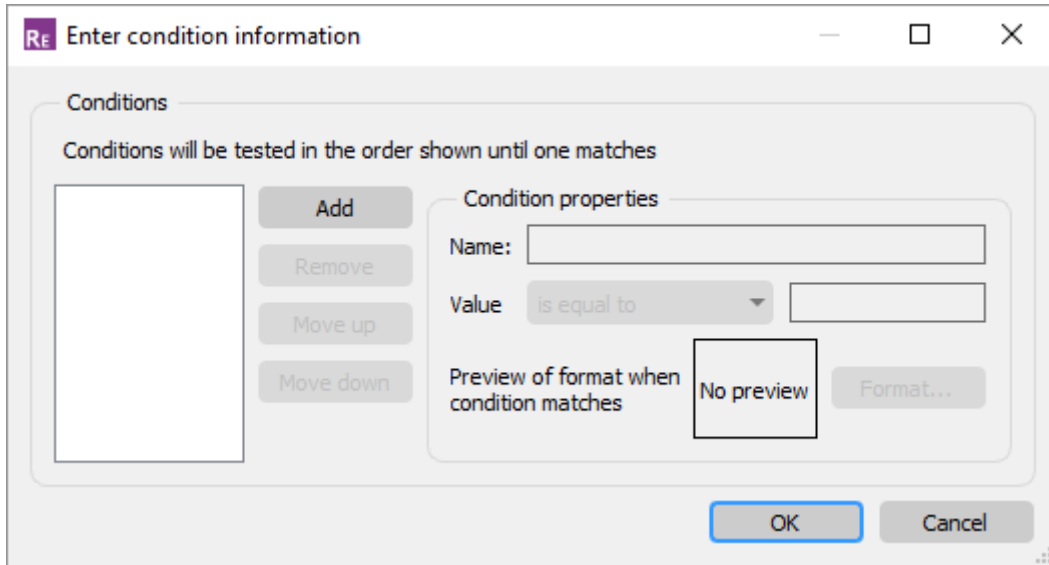

Conditions can be added and removed by using the **Add** and **Remove** buttons. If you have more than one condition, they are tested in the order shown. If the first condition passes the test then that is used, otherwise the second is tested etc. If none of the conditions pass the default font properties for the object are chosen. As the order that they are evaluated is important you can use the **Move up** and **Move down** buttons to change the order.

Once a condition has been added it is given a default name and the [condition type](#) is initially set to 'is equal to'

Choose the [condition type](#) that you want (see the next section for details) and give the necessary values. For example in the image below the condition will be true if the value is a number between 10.0 and 100.0.

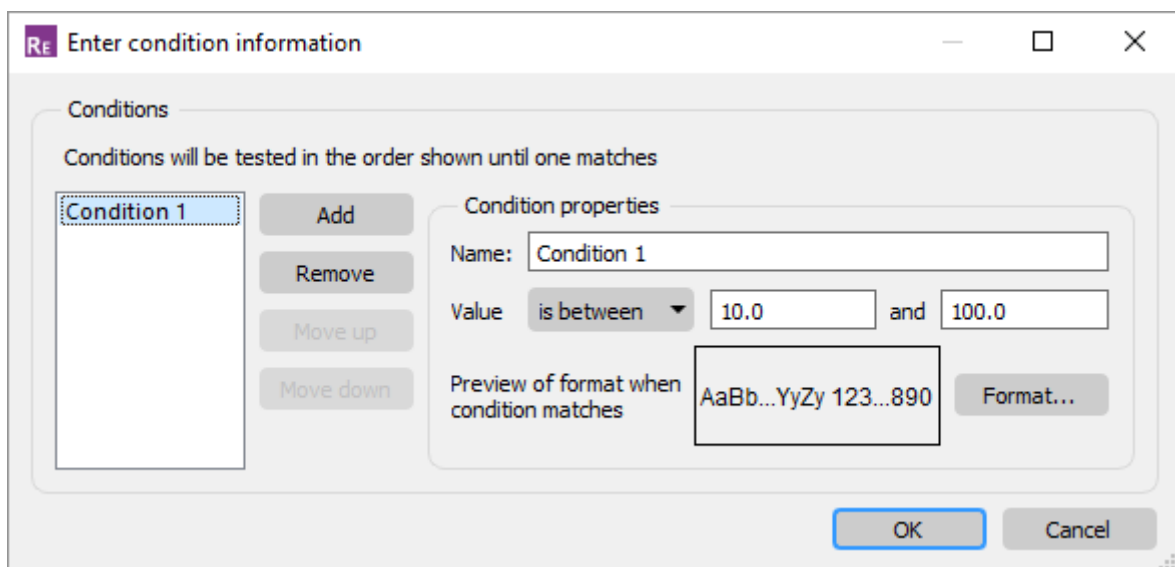

Once you have the correct condition type, the **Format...** button can be used to select the font properties that you want to assign for this condition. In the window (shown below) you can set the font, the style, justification, font size and colour properties.

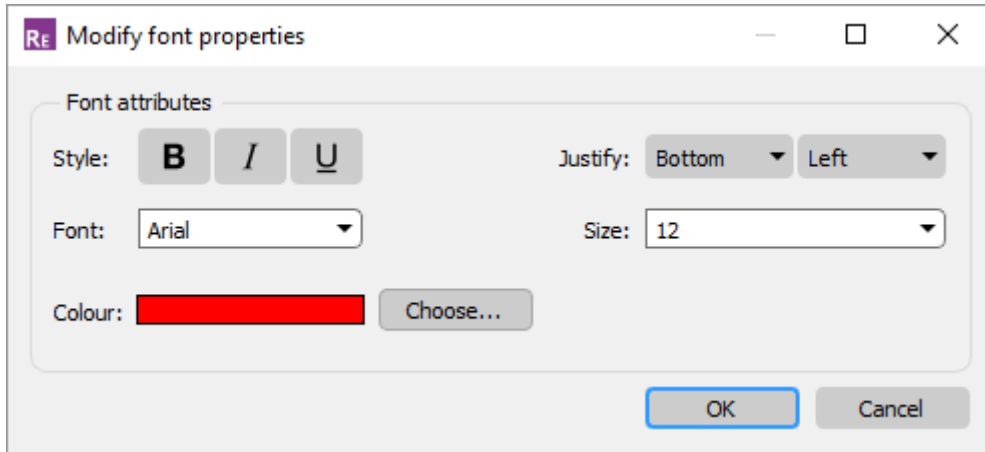

When you change the font properties, the preview updates to show what the text will look like for this condition. Additionally you can rename the condition to a more meaningful name if required. e.g. in the image below we have made a condition called Danger which will format the text in bold red if the value is a number between 10 and 100.

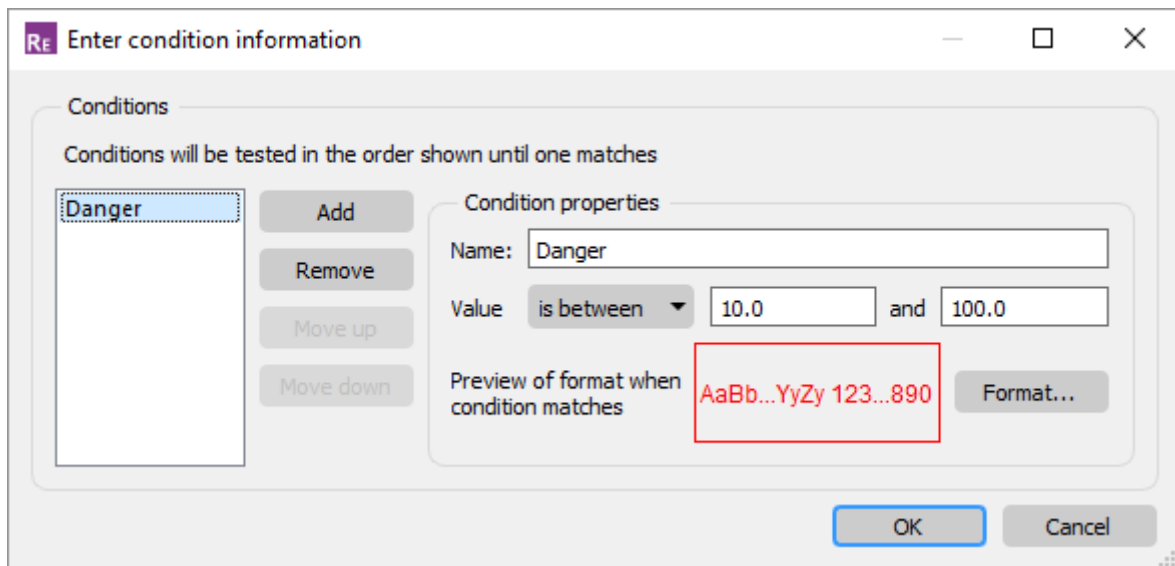

This process can be repeated as necessary to add as many conditions as you wish.



16.2. Condition Types

11.2. Condition types

Condition type	Description
is equal to	Treats the value as a string. Strips leading and trailing white space from the string and compares it to the condition value. TRUE if the strings are identical. This can also be used to compare integers but should not be used to compare floating point numbers.
is not equal to	As above, but TRUE if the strings are different
is greater than	Treats the value as a real number. It first tries to convert the value and the condition value to real numbers. If this fails the condition is FALSE. If it succeeds then the condition is TRUE if the value is greater than the condition value.
is less than	As above, but TRUE if the value is less than the condition value.
is between	As above, but TRUE if the value is between the two condition values.
is not between	As above, but TRUE if the value is not between the two condition values.
contains string	Treats the value as a string. TRUE if the value contains the condition string.
does not contain string	Treats the value as a string. TRUE if the value does not contain the condition string.
matches regex	Treats the value as a regular expression . TRUE if the regular expression matches.
does not match regex	Treats the value as a regular expression . TRUE if the regular expression does not match.



16.2.1. Regular Expressions

Regular expressions

REPORTER understands most of the basic operators of perl regular expressions. This section gives a brief introduction into regular expressions (or regexps). For more details please see a suitable book on regular expressions such as Programming Perl.

Regexps are built up from expressions, quantifiers, and assertions. The simplest form of expression is simply a character, e.g. `x` or `5`. An expression can also be a set of characters. For example, `[ABCD]`, will match an `A` or a `B` or a `C` or a `D`. As a shorthand we could write this as `[A-D]`. If we want to match any of the capital letters in the English alphabet we can write `[A-Z]`. A quantifier tells the regexp engine how many occurrences of the expression we want, e.g. `x{1,1}` means match an `x` which occurs at least once and at most once. We'll look at assertions and more complex expressions later.

We'll start by writing a regexp to match integers in the range 0 to 99. We will require at least one digit so we will start with `[0-9]{1,1}` which means match a digit exactly once. This regexp alone will match integers in the range 0 to 9. To match one or two digits we can increase the maximum number of occurrences so the regexp becomes `[0-9]{1,2}` meaning match a digit at least once and at most twice. However, this regexp as it stands will not match correctly. This regexp will match one or two digits within a string. To ensure that we match against the whole string we must use the anchor assertions. We need `^` (caret) which when it is the first character in the regexp means that the regexp must match from the beginning of the string. And we also need `$` (dollar) which when it is the last character in the regexp means that the regexp must match until the end of the string. So now our regexp is `^[0-9]{1,2}$`. Note that assertions, such as `^` and `$`, do not match any characters.

If you've seen regexps elsewhere they may have looked different from the ones above. This is because some sets of characters and some quantifiers are so common that they have special symbols to represent them. `[0-9]` can be replaced with the symbol `\d`. The quantifier to match exactly one occurrence, `{1,1}`, can be replaced with the expression itself. This means that `x{1,1}` is exactly the same as `x` alone. So our 0 to 99 matcher could be written `^\d{1,2}$`. Another way of writing it would be `^\d\d{0,1}$`, i.e. from the start of the string match a digit followed by zero or one digits. In practice most people would write it `^\d\d?$`. The `?` is a shorthand for the quantifier `{0,1}`, i.e. a minimum of no occurrences a maximum of one occurrence. This is used to make an expression optional. The regexp `^\d\d?$` means "from the beginning of the string match one digit followed by zero or one digits and then the end of the string".

Our second example is matching the words 'mail', 'letter' or 'correspondence' but without matching 'email', 'mailman', 'mailer', 'letterbox' etc. We'll start by just matching 'mail'. In full the regexp is `m{1,1}a{1,1}i{1,1}l{1,1}`, but since each expression itself is automatically quantified by `{1,1}` we can simply write this as `mail`; an 'm' followed by an 'a' followed by an 'i' followed by an 'l'. The symbol `|` (bar) is used for alternation, so our



regex now becomes `mail|letter|correspondence` which means match 'mail' or 'letter' or 'correspondence'. Whilst this regex will find the words we want it will also find words we don't want such as 'email'. We will start by putting our regex in parentheses, `(mail|letter|correspondence)`. Parentheses have two effects, firstly they group expressions together and secondly they identify parts of the regex that we wish to capture. Our regex still matches any of the three words but now they are grouped together as a unit. This is useful for building up more complex regexs. It is also useful because it allows us to examine which of the words actually matched. We need to use another assertion, this time `\b` "word boundary": `\b(mail|letter|correspondence)\b`. This regex means "match a word boundary followed by the expression in parentheses followed by another word boundary". The `\b` assertion matches at a position in the regex not a character in the regex. A word boundary is any non-word character such as a space a newline or the beginning or end of the string.

For our third example we want to replace ampersands with the HTML entity '&'. The regex to match is simple: `&`, i.e. match one ampersand. Unfortunately this will mess up our text if some of the ampersands have already been turned into HTML entities. So what we really want to say is replace an ampersand providing it is not followed by 'amp;'. For this we need the negative lookahead assertion and our regex becomes: `&(?!amp;)`. The negative lookahead assertion is introduced with '(?!' and finishes at the ')'. It means that the text it contains, 'amp;' in our example, must not follow the expression that precedes it.

Characters and Abbreviations in regular expressions

Element	Meaning
<code>c</code>	Any character represents itself unless it has a special regex meaning. Thus <code>c</code> matches the character <code>c</code> .
<code>\c</code>	A character that follows a backslash matches the character itself except where mentioned below. For example if you wished to match a literal caret at the beginning of a string you would write <code>\^</code> .
<code>\a</code>	This matches the ASCII bell character (BEL, 0x07).
<code>\f</code>	This matches the ASCII form feed character (FF, 0x0C).
<code>\n</code>	This matches the ASCII line feed character (LF, 0x0A, Unix newline).
<code>\r</code>	This matches the ASCII carriage return character (CR, 0x0D).
<code>\t</code>	This matches the ASCII horizontal tab character (HT, 0x09).
<code>\v</code>	This matches the ASCII vertical tab character (VT, 0x0B).
<code>\xhhh</code>	This matches the Unicode character corresponding to the hexadecimal number <code>hhh</code> (between 0x0000 and 0xFFFF). <code>\0ooo</code> (i.e., <code>\zero ooo</code>) matches the ASCII/Latin-1 character corresponding to the octal number <code>ooo</code> (between 0 and 0377).



. (dot)	This matches any character (including newline).
\d	This matches a digit.
\D	This matches a non-digit.
\s	This matches a whitespace.
\S	This matches a non-whitespace.
\w	This matches a word character
\W	This matches a non-word character

Sets of Characters

Square brackets are used to match any character in the set of characters contained within the square brackets. All the character set abbreviations described above can be used within square brackets. Apart from the character set abbreviations and the following two exceptions no characters have special meanings in square brackets.

^	The caret negates the character set if it occurs as the first character, i.e. immediately after the opening square bracket. For example, [abc] matches 'a' or 'b' or 'c', but [^abc] matches anything except 'a' or 'b' or 'c'.
-	The dash is used to indicate a range of characters, for example [W-Z] matches 'W' or 'X' or 'Y' or 'Z'.

Using the predefined character set abbreviations is more portable than using character ranges across platforms and languages. For example, [0-9] matches a digit in Western alphabets but \d matches a digit in any alphabet.

Quantifiers

By default an expression is automatically quantified by {1,1}, i.e. it should occur exactly once. In the following list E stands for any expression. An expression is a character or an abbreviation for a set of characters or a set of characters in square brackets or any parenthesised expression.

E?	Matches zero or one occurrence of E. This quantifier means "the previous expression is optional" since it will match whether or not the expression occurs in the string. It is the same as E{0,1}. For example dents? will match 'dent' and 'dents'.
E+	Matches one or more occurrences of E. This is the same as E{1,MAXINT}. For example, 0+ will match '0', '00', '000', etc.
E*	Matches zero or more occurrences of E. This is the same as E{0,MAXINT}. The * quantifier is often used by a mistake. Since it matches zero or more

	occurrences it will match no occurrences at all. For example if we want to match strings that end in whitespace and use the regexp <code>\s*\$</code> we would get a match on every string. This is because we have said find zero or more whitespace followed by the end of string, so even strings that don't end in whitespace will match. The regexp we want in this case is <code>\s+\$</code> to match strings that have at least one whitespace at the end.
$E\{n\}$	Matches exactly n occurrences of the expression. This is the same as repeating the expression n times. For example, $x\{5\}$ is the same as $xxxxx$. It is also the same as $E\{n,n\}$, e.g. $x\{5,5\}$.
$E\{n,\}$	Matches at least n occurrences of the expression. This is the same as $E\{n,MAXINT\}$.
$E\{,m\}$	Matches at most m occurrences of the expression. This is the same as $E\{0,m\}$.
$E\{n,m\}$	Matches at least n occurrences of the expression and at most m occurrences of the expression.

(MAXINT is implementation dependent but will not be smaller than 1024.)

If we wish to apply a quantifier to more than just the preceding character we can use parentheses to group characters together in an expression. For example, `tag+` matches a 't' followed by an 'a' followed by at least one 'g', whereas `(tag)+` matches at least one occurrence of 'tag'.

Note that quantifiers are "greedy". They will match as much text as they can. For example, `0+` will match as many zeros as it can from the first zero it finds, e.g. '2. **000** 5'.

Assertions

Assertions make some statement about the text at the point where they occur in the regexp but they do not match any characters. In the following list E stands for any expression.

\wedge	The caret signifies the beginning of the string. If you wish to match a literal \wedge you must escape it by writing $\wedge\wedge$. For example, $\wedge\#\text{include}$ will only match strings which begin with the characters '#include'. (When the caret is the first character of a character set it has a special meaning, see Sets of Characters.)
$\$$	The dollar signifies the end of the string. For example $\text{d}\wedge\text{s}*\$$ will match strings which end with a digit optionally followed by whitespace. If you wish to match a literal $\$$ you must escape it by writing $\backslash\$$.
$\backslash\text{b}$	A word boundary. For example the regexp $\backslash\text{bOK}\backslash\text{b}$ means match immediately after a word boundary (e.g. start of string or whitespace) the letter 'O' then the letter 'K' immediately before another word boundary (e.g. end of string or whitespace). But note that the assertion does not actually match any whitespace



	so if we write <code>(\bOK\b)</code> and we have a match it will only contain 'OK' even if the string is "Its OK now".
<code>\B</code>	A non-word boundary. This assertion is true wherever <code>\b</code> is false. For example if we searched for <code>\Bon\b</code> in "Left on" the match would fail (space and end of string aren't non-word boundaries), but it would match in "tonne".
<code>(?=E)</code>	Positive lookahead. This assertion is true if the expression matches at this point in the regexp. For example, <code>const(?=\s+char)</code> matches 'const' whenever it is followed by 'char', as in 'static const char *'. (Compare with <code>const\s+char</code> , which matches 'static const char *'.)
<code>(?!E)</code>	Negative lookahead. This assertion is true if the expression does not match at this point in the regexp. For example, <code>const(?!\s+char)</code> matches 'const' except when it is followed by 'char'.



17. Fonts

17.1. Supported Fonts

Supported Fonts

REPORTER supports most fonts, giving you control over the look of your reports, and allowing you to create templates that match your organisations branding. The following font types are supported:

- TrueType fonts and collections (*.ttf* and *.ttc* files)
- OpenType fonts and collections (*.otf* and *.otc* files)
- Certain Type1 fonts (Printer Font Binary *.pfb* files and their *.pfm* metrics files)

The fonts that appear in REPORTER s font dialogs depend on the fonts available on your operating system. REPORTER searches the following locations for fonts:

On Windows:

- *%WINDIR%\Fonts* (typically *C:\Windows\Fonts*)

On Linux:

- */usr/share/fonts*
- */usr/share/X11*
- */usr/local/share/fonts*

When REPORTER launches, it scans these locations for font files, processes the files it finds, and then writes the data to a cache file located at *\$OA_HOME/reporter_font_cache* . On subsequent launches, REPORTER should load more quickly, because thereafter it only needs to process newly installed fonts.

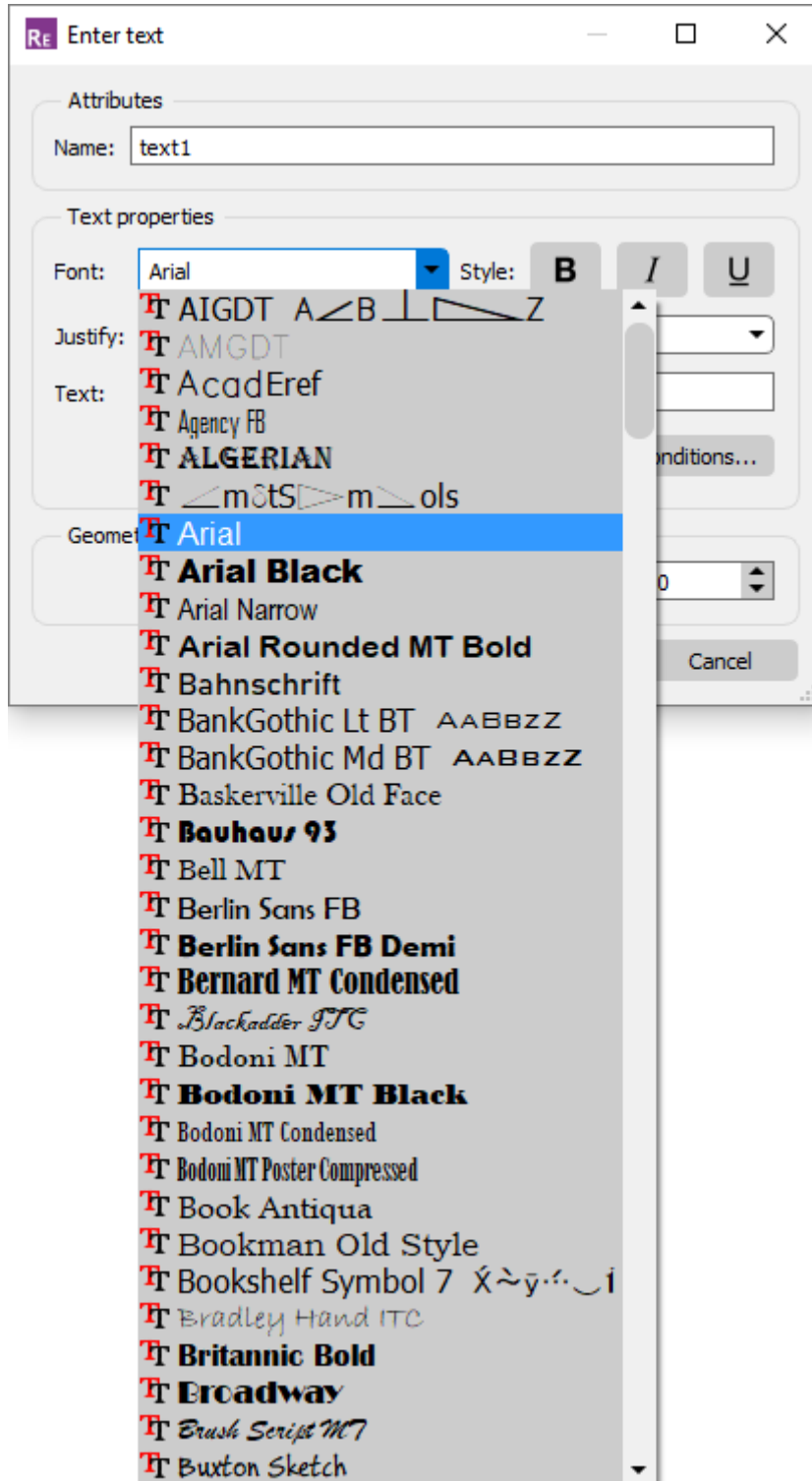



17.2. Legacy Fonts

Legacy Fonts

In addition, the four **legacy** fonts are always supported regardless of operating system:

- Courier
- Helvetica
- Symbol
- Times

This means that REPORTER templates created using earlier versions (before REPORTER 16.0, when only these four fonts were available) should continue to work as normal.

17.3. Font Mapping

Font Mapping

Font mapping is a method of providing suitable alternatives if a requested font is unavailable on your system. For example, another user may share with you a REPORTER template containing selected fonts that were available on their system, but not on yours. Alternatively, you might create a template on your Windows computer, and then generate it in batch on a Linux server that has a different set of fonts installed.



17.3.1. Font Substitution Dialog

Font Substitution Dialog

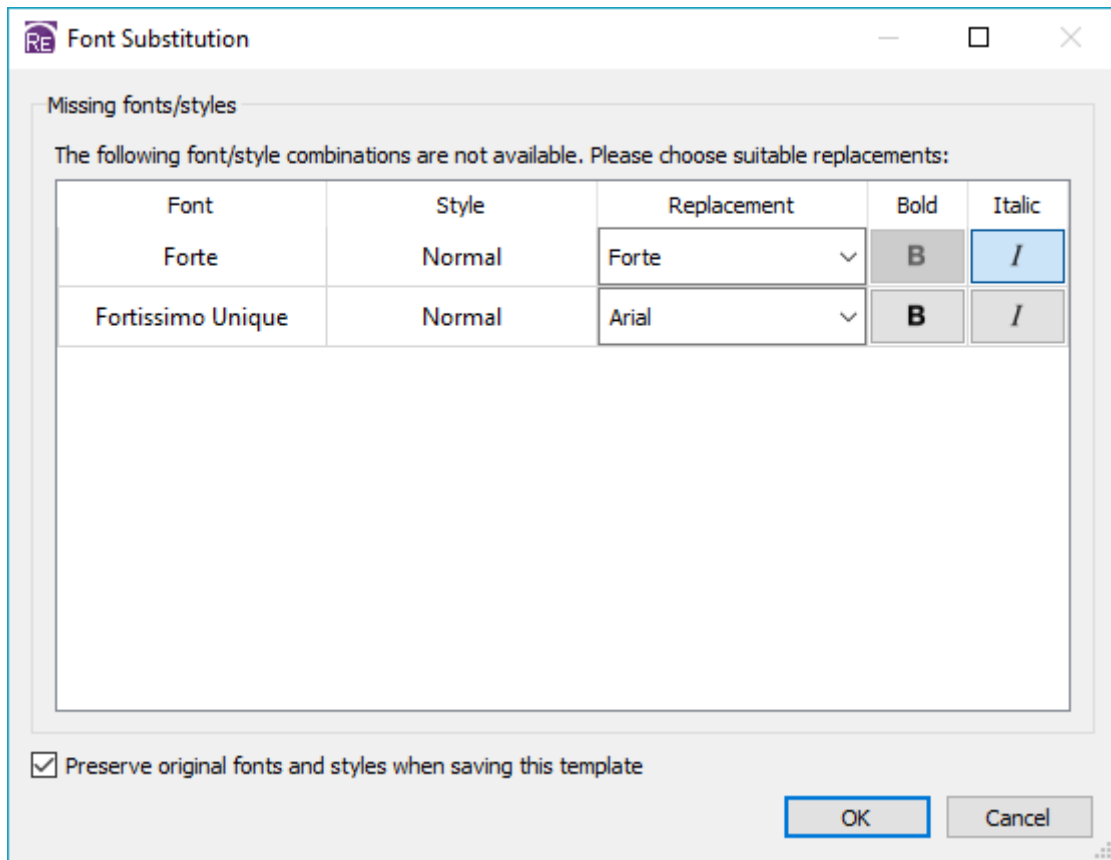

If you open a REPORTER template containing fonts that are missing from your system, a Font Substitution dialog will appear:

In the example above, the font Forte is available on the system, but the style Normal is not available, so Forte Italic is being offered as a replacement. The font Fortissimo Unique cannot be found on the system, so Arial is being offered as a replacement. If you want to change the default replacement, you can select a different font from the drop-down list, and check or uncheck the Bold and Italic buttons. Note that for some fonts, certain style combinations might be unavailable. In the example above, Forte Bold is unavailable so the Bold button is disabled.

Below the list of missing font/style combinations, there is an option to Preserve original fonts and styles when saving this template (selected by default). When selected, the original font names and styles will be written when the template is saved. This is useful when you want to work on or edit another users template without irreversibly changing the original fonts. It is also useful if you regularly create a template on Windows but then generate it on a Linux server. When run in batch, Preserve original fonts and styles when saving this template is switched on by default, meaning that your original Windows font names will be used in any report and PowerPoint files generated (useful if you normally then view the output back on Windows).



If you want to save the Font Substitution dialog replacements as permanent changes to your template, simply uncheck the Preserve original fonts and styles when saving this template option.



17.3.2. Font Mapping Table

Font Mapping Table

REPORTER uses a font mapping table to determine which font to offer as a suitable replacement for any given font. An extract from the font mapping table is shown below:

font-family	generic	replacement	replacement 2
Arial Special	sans-serif	Arial	Helvetica
Arial Unicode MS	sans-serif	Arial	Helvetica
Bahnschrift	sans-serif		
Baskerville Old Face	serif		
Batang	serif		
BatangChe	serif		
Bauhaus 93	fantasy		
Beesknees ITC	fantasy		
Bell MT	serif	Bitstream Charter	
Berlin Sans FB	sans-serif		
Bernard MT Condensed	serif		
Bon Appetit MT	monospace		
Book Antiqua	serif	Palatino Linotype	DejaVu Serif
Bookman	serif	Bookman Old Style	
Bookman Old Style	serif	Bookman	
Bookshelf Symbol	symbol		
Bradley Hand ITC	cursive		

The font mapping table supplied in the REPORTER installation was compiled from lists of common font mapping alternatives for Windows and Linux. For some fonts, one or two specifically named fonts are given as **replacement** and **replacement 2**. Often, these are alternatives within a font family (e.g. Arial Unicode MS Arial) or typical Linux replacements for typical Windows fonts (e.g. Bell MT Bitstream Charter). All of the fonts in the mapping table have a **generic** replacement type. This can be one of:

- cursive
- fantasy
- monospace
- sans-serif
- serif
- symbol



These generic categories are the same as the widely recognised Cascading Style Sheets (CSS) *font-family* property generic categories, with the addition of **symbol** (an extra generic category added in REPORTER to aid support of the legacy font Symbol).

If REPORTER encounters a missing font, it will search first for the **replacement** font, and then the **replacement 2** font (if either is specified). If neither of those fonts are available, it will search for the generic default. These are:

generic	Windows	Linux
cursive	Monotype Corsiva	URW Chancery L
fantasy	Impact	Impact
monospace	Courier New	Courier 10 Pitch
sans-serif	Arial	Liberation Sans
serif	Times New Roman	Nimbus Roman No9 L
symbol	Symbol	Standard Symbols L

Failing that, it will use the generic sans-serif default (Arial on Windows, Liberation Sans on Linux). This will happen if the requested font is not featured in the font mapping table, or if one of the generic defaults is not installed.

The generic default fonts listed above can be customised via Oasys preferences (the *oa_pref* file).

The font mapping table is stored in CSV format at *\$OA_INSTALL/reporter_library/fonts/font_mapping.csv* . Please contact Oasys Ltd Support if you encounter repeated font substitution issues. Alternatively, you can edit it to customise your own font mappings. You can also specify a font mapping CSV file at an alternative location to the installation location by using the preference *reporter*font_mapping_table* .

17.4. Fonts in Report Output

Fonts in report output

Fonts are handled slightly differently in each of the supported output formats (PowerPoint, HTML and PDF).



PowerPoint

Font names and styles in the REPORTER template are written to the PowerPoint file. When the file is opened, Microsoft PowerPoint will use the requested font name if available. If it is unavailable (e.g. if the PowerPoint file was created by a user with access to different fonts from you) then PowerPoint will try to use a suitable alternative, or will revert to the default font. This behaviour is no different from normal PowerPoint use.

If you create a template on Windows but then generate it in batch on a Linux server, Preserve original fonts and styles when saving this template is switched on by default. This means that your original Windows font names will be used in the PowerPoint output (useful when the PowerPoint is viewed back on a Windows computer).

HTML

Font names in the REPORTER template are written to the *font-family* property in the HTML file using the information in the font mapping table. For example, if you have selected Times New Roman, the following may appear in HTML:

```
font-family:"Times New Roman","Times","Nimbus Roman No9 L",serif;
```

Your web/HTML browser will try to display the text in Times New Roman, followed by the alternative fonts listed (using similar logic to REPORTER). In this way, compatibility between systems is preserved as far as possible.

PDF

PowerPoint and HTML files just contain the *names* of the fonts used. However, fonts are only supported properly by PDF readers if the relevant subset of the font file itself is embedded in the PDF file. When REPORTER writes PDF output, it will only embed fonts with the appropriate permission bits. If you encounter an error when writing PDF files, check that the fonts you have selected do not have licence restrictions on embeddability.



18. Scripting



18.1. JavaScript

JavaScript

REPORTER has a JavaScript interpreter embedded in it to enable you to perform complex operations through scripts. There are currently 3 ways to run a script in REPORTER.

- Running a library script installed in the `/library/scripts` directory.
- Inserting a script object onto a page. This does not create any direct output itself, but can create output which other objects in the template use.
- Running a script from the command line with the `-script` option.

While most people associate JavaScript with web pages and html, it is a full-featured programming language. Additionally, JavaScript is not Java! JavaScript is completely unrelated to Java.

Hopefully, enough people are familiar enough with JavaScript through the internet to be able to use it in REPORTER. JavaScript has all of the functionality you would expect from a programming language, such as:

- variables (strings, numbers, booleans, objects, arrays)
- functions
- control flow statements such as `if` , `while` , `do` , `for` , `switch` etc.
- objects
- arrays
- regular expressions
- maths functions (sin cos, log, sqrt etc)

Additionally, REPORTER extends JavaScript by defining several new object classes specifically for REPORTER . A detailed reference on these classes is given in the JavaScript reference manual. Over time this functionality may be extended. If you need to do something which is not possible with the current functionality then contact Oasys Ltd Support.

This chapter is not intended to be an introduction or a tutorial for JavaScript. There are many resources on the web for that. However, a few examples are given to show the sort of things that are possible with scripts. Additionally, there are several good books on JavaScript. Highly recommended is JavaScript, The Definitive Guide by David Flanagan, published by O'Reilly, ISBN: 0-596-00048-0.

REPORTER supports ECMAScript 6 (and newer) features of JavaScript.

Probably the best way to see what sort of things are easily possible in REPORTER using JavaScript is to look at the library scripts which are given out with REPORTER in the `/library/scripts` directory. For more details of the scripts see [Standard library programs](#).



18.1.1. ECMAScript 6 Modules

ECMAScript 6 Modules

REPORTER supports ES6 modules. For more information on ES6 modules please refer to <https://developer.mozilla.org/en-US/docs/Web/JavaScript/Guide/Modules>.

ES6 modules give JavaScript built-in support for modular programming using the `import` and `export` keywords. REPORTER now supports both static and dynamic imports for modules.

To be able to support ES6 modules, REPORTER has to compile the script in a different way to a 'normal' script that does not use modules. In order for REPORTER to detect whether a script uses modules, the file being run needs to have the extension `.mjs`. This follows the convention used by [V8](#) and [Node.js](#). Alternatively, you can use the extension `.js`, but you then need to add a special `/* module: TRUE */` comment on one of the first twenty lines of the script. For script items, the module comment is necessary as you are not running a script file.

All "normal" scripts in REPORTER share a "context", which means that all variables and functions declared in the global scope are shared across these scripts. Therefore, any variable or function defined in one script can be accessed or modified by another script running in the same instance of REPORTER. Sharing data between scripts can also be done using template variables.

Note, however, that modules work differently. Any variables or functions declared in the global scope of a module script will only be available in the "context" of that script. The modules will still have access to any variables or functions declared in the global scope of "normal" scripts.

When importing modules, if using a relative module filename, REPORTER will search for the file in the following order:

1. Relative to the directory that the main script is in
2. Relative to any parent module directory
3. Relative to the current directory
4. Relative to the script directory specified in the HOME directory. By default this will be `$HOME/reporter_library/scripts` but this can be changed with the `script_directory` preference in the HOME `oa_pref` file
5. Relative to the script directory specified in the OA_INSTALL directory. By default this will be `$OA_INSTALL/reporter_library/scripts` but this can be changed with the `script_directory` preference in the OA_INSTALL `oa_pref` file
6. Relative to the script directory specified in the OA_ADMIN directory. By default this will be `$OA_ADMIN/reporter_library/scripts` but this can be changed with the `script_directory` preference in the OA_ADMIN `oa_pref` file



Keep in mind that if you are using a script item as a module, this will be saved to a temporary directory to allow it to be compiled and executed. That means that the algorithm will first search there to resolve any module relative paths.



18.1.2. Example Scripts

18.1.2.1. Example : 1 Percent Change in Two Values

Example 1: Percent change in two values

Problem

Take two input variables VALUE and VALUE_BASE

Calculate new variable PERCENT = $100 * (VALUE - VALUE_BASE) / VALUE_BASE$

Check if VALUE_BASE=0 and if so don't do the division but set PERCENT to 100

Solution

Copy Code

JavaScript

```
var percent;

// Get variable values from template
var value = reporter.currentTemplate.GetVariableValue("VALUE");
var base_value =
reporter.currentTemplate.GetVariableValue("VALUE_BASE");

// Check that the variables exist
if (value == null) throw Error("no VALUE variable
");
if (base_value == null) throw Error("no VALUE_BASE variable
");

// Extract numbers from variables
var v = parseFloat(value);
var bv = parseFloat(base_value);

// Check that the variables are valid numbers
if (isNaN(v)) throw Error("VALUE " + value + " is not a valid
number
");
if (isNaN(bv)) throw Error("VALUE_BASE " + base_value + " is not a
valid number
");

// Check for zero (very small) base value
if (Math.abs(bv) < 1.0e-20)
    percent = 100;
else
    percent = 100*((v-bv)/bv);

// Create new variable PERCENT
var pvar = new Variable(reporter.currentTemplate, "PERCENT",
"Percent change", percent.toFixed(2));
```



Discussion

Variables in REPORTER are stored in each template so to get the values of the variables `VALUE` and `VALUE_BASE` we need to get the template that we are using. The easiest way to do this is to use the `currentTemplate` property of the reporter object that is created when REPORTER starts. Once we have the template there is a method `GetVariableValue` that allows us to get a variable value.

`GetVariableValue` returns the value of the variable as a string or null if the variable does not exist. We can easily check for this and terminate with an error if the variable is missing.

We want to get the numerical values of the variables and check if they are valid numbers. The standard JavaScript functions `parseFloat()` and `isNaN()` allow us to do this.

To check if the value is zero (or very small) we use the standard `Math.abs()` function and calculate a value accordingly.

To create a new variable we use the `Variable` constructor. This takes the template, the variable name, description and value as arguments. Finally, maths in JavaScript is performed in double precision so the value we calculated will be given to many significant figures. We are not interested in this so we use the standard `Number.toFixed()` function to limit the number of decimal places to 2.

The source code for this example is available [here](#).



18.1.2.2. Example 2: Magnitude from the Three Vector Components

Example 2: Magnitude from the three vector components

Problem

Given three variables X, Y and Z calculate the vector magnitude and store it in a variable LENGTH.

Solution

Copy Code
JavaScript

```
// Get variable values from template
var x = Template.GetCurrent().GetVariableValue("X");
var y = Template.GetCurrent().GetVariableValue("Y");
var z = Template.GetCurrent().GetVariableValue("Z");

// Check that the variables exist
if (x == null) throw Error("no X variable");
if (y == null) throw Error("no Y variable");
if (z == null) throw Error("no Z variable");

// Extract numbers from variables
var X = parseFloat(x);
var Y = parseFloat(y);
var Z = parseFloat(z);

// Check that the variables are valid numbers
if (isNaN(X)) throw Error("X " + x + " is not a valid number");
if (isNaN(Y)) throw Error("Y " + y + " is not a valid number");
if (isNaN(Z)) throw Error("Z " + z + " is not a valid number");

// Calculate magnitude
var length = Math.sqrt(X*X + Y*Y + Z*Z);

// Check for valid magnitude
if (isNaN(length)) throw Error("Bad vector magnitude");

// Create new variable LENGTH
var lvar = new Variable(Template.GetCurrent(), "LENGTH",
    "vector magnitude", length);
```

Discussion

This is done using very similar methods to example 1. The only differences here are using the function `Math.sqrt()` and we do not use the standard `Number.toFixed()` function as the length could be smaller than 2 decimal places. Instead we could use



`Number.toPrecision()` or `Number.toExponential()` if we wanted to format the result instead of leaving it with several decimal places.

The source code for this example is available [here](#).



18.1.2.3. Example 3: Setting a Character Variable According to the Result of a Calculation

Example 3: Setting a character variable according to the result of a calculation

Problem

Input variable = PERCENT

If $(\text{abs}(\text{PERCENT}) < 5.0)$ then new variable RESULT = 'OK'

otherwise 'not OK'

Solution

Copy Code

JavaScript

```
var result;

// Get variable value from template
var percent = reporter.currentTemplate.GetVariableValue("PERCENT");

// Check that the variable exist
if (percent == null) throw Error("no PERCENT variable
");

// Extract number from variable
var p = parseFloat(percent);

// Check that the variable is a valid number
if (isNaN(p)) throw Error("PERCENT " + percent + " is not a valid
number
");

// Check for less than 5
if (Math.abs(p) < 5.0)
    result = "OK";
else
    result = "not OK";

// Create new variable RESULT
var rvar = new Variable(reporter.currentTemplate, "RESULT",
    "is it OK?", result);
```

Discussion

This uses exactly the same methods as examples 1 and 2. The only difference is that the value used in the Variable constructor is a character string, not a number.

The source code for this example is available [here](#).



18.1.2.4. Example 4: Reading a T/HIS Curve File and Operating on it

Example 4: Reading a T/HIS curve file and operating on it

Problem

input variables = CURVE_FILE and GATE_TIME.
read the T/HIS curve file, calculate average y-value of all points that occur after x-value=GATE_TIME. Return the average in a new variable Y_AVERAGE

Solution

Copy Code
JavaScript

```
var count, line, x, y, X, Y, ytot, ny;

// Get variable values from template
var curveFile =
reporter.currentTemplate.GetVariableValue("CURVE_FILE");
var gateTime =
reporter.currentTemplate.GetVariableValue("GATE_TIME");

// Check that the variables exist
if (curveFile == null) throw Error("no CURVE_FILE variable
");
if (gateTime == null) throw Error("no GATE_TIME variable
");

// Check curve file exists
if (!File.Exists(curveFile)) throw Error("Curve file " + curveFile
+ " does not exist
");

// Check gateTime is a valid number
var t = parseFloat(gateTime);
if (isNaN(t)) throw Error("Gate time " + gateTime + " is not a
valid number
");

// create a new File object
var file = new File(curveFile, File.READ);

// Zero variables
count = 0;
ytot = 0;
ny = 0;

// Keep reading lines from the file until we get to the end of the
file
while ( (line = file.ReadLine() ) != File.EOF)
{
```

```

    if (line.charAt(0) == '$')
        continue;
    else if (line.match(/CONTINUE/))
        break;
    else
    {
        count++;

// Skip the four title lines at the top of the curve file
        if (count > 4)
        {
// strip leading and trailing apaces
            line = line.replace(/^\s+/, "");
            line = line.replace(/\s+$/, "");
            result = line.match(/([0-9eE+\-\.\.])\s*,?\s*([0-9eE+\-
\.\.])+//);
            if (result != null)
            {
                x = result[1];
                y = result[2];

// Extract numbers
                X = parseFloat(x);
                Y = parseFloat(y);

// Check that they are valid numbers
                if (isNaN(X)) throw Error("X " + x + " is not a
valid number
");
                if (isNaN(Y)) throw Error("Y " + y + " is not a
valid number
");

// If greater than gate time then include value
                if (X > t)
                {
                    ny++;
                    ytot += Y;
                }
            }
        }
    }

// Close the file
file.Close();

// If we have read any values calculate average and set variable
if (ny)
{
    ytot /= ny;
// Create new variable LENGTH
    var ave = new Variable(reporter.currentTemplate, "Y_AVERAGE",
"average Y value", ytot);
}

```



Discussion

This example uses the `File` class which REPORTER defines to read the T/HIS curve file. The function `File.Exists()` can be used to test if a filename is valid. Then the `File` constructor, `ReadLine()` and `Close()` functions are used to read the data from the file.

To extract the xy data pairs from the file we use a regular expression. This is perhaps the most complicated part of the program. We want to be able to read x and y values that can be separated by a comma, one or more spaces, or both. If we break the expression `([0-9eE+\-\.\.]+)\s*,?\s*([0-9eE+\-\.\.]+)` into it's constituent parts we get:

`([0-9eE+\-\.\.]+)` . The `[]` groups characters that we allow to match. `-` and `.` have special meanings so they have to be escaped with a `\` character. So this means we are allowing any of the characters `0123456789eE+-.` to match. The `[]` specifies a single character so we use `+` to mean one or more. Finally, using `()` captures the expression so we can extract the value that matched. So this will match values such as `'10'`, `'1.2345'`, `'1.0e+05'`, `'-23.4'`

`\s*,?\s*` . The `\s` matches a single space. A `*` means that it will try to match 0 or more spaces (as many as are present). The `,` matches a comma and the `?` means match either 0 or 1 of them. So this expression means "Match 0 or more spaces followed by 0 or 1 commas followed by 0 or more spaces".

More details on regular expressions can be found in the [Regular expressions](#) as these can use regular expressions.

Once we have extracted the data values with the regular expression we can easily calculate the average and make a new variable using the techniques in the first 3 examples.

The source code for this example is available [here](#).



18.2. Python

Python

Python is a high-level, general-purpose programming language. It is dynamically typed, garbage-collected and with an emphasis on code readability and compact syntax.

Starting with REPORTER 21.0, a new Python API has been introduced, promising enhanced flexibility and functionality for projects. This API mirrors the classes, methods and properties found in the JavaScript API, while also leveraging Python's great performance in CPU-intensive tasks and data processing.

The main advantages of the Python API are:

- Python scripts run **outside** the programs (REPORTER, PRIMER, etc.), not **inside**, as JavaScript scripts do. This makes it more versatile as it allows the same Python script to connect to multiple programs (REPORTER, PRIMER, etc.);
- The same script can be used for data processing, file manipulation and/or to communicate with other software that feature a Python API, e.g. Ansys LS-DYNA, Microsoft Excel, etc;
- Python is a beginner-friendly language with a short learning curve;
- Python is an authentic object-oriented programming language that allows for the creation of class-based inheritance structures;
- There are many modules and libraries ready-to-use in Python which can easily be installed via a package manager and imported into the script.

For more information on the Python API, see the [Python API reference manual](#).

For a tutorial on how to use the Python API in REPORTER, see [REPORTER Tutorials](#).



19. Workflows Updates

Workflows 23.0 (released with Oasys Suite 23.0)

Many pre- and post-processors offer a range of tools that can be used to configure and interrogate Ansys LS-DYNA models. However:

1. The basic tools are not always customised for Ansys LS-DYNA, or for specific loadcases
2. You may need to perform many manual steps to process your results, which can be time-consuming and prone to error
3. Scripting APIs can be used to create tools to automate tasks, but this requires time, resource and knowledge, which is not always available

To address these issues, we introduced Workflows. Workflows is a powerful framework that provides you with customised tools that work seamlessly from pre-processing through to post-processing, providing results quickly and reliably.

Workflow Tools

[Learn how to use the latest Workflow tools here.](#)

[Learn about Workflow User Data.](#)

In addition to the tools provided, you can create your own bespoke tools. Please [contact us](#) if you have an idea for a tool and would like some help creating it.

Releases

The Workflows tools are constantly being improved and enhanced. If you have any requests for new features or experience issues using Workflows, please [contact us](#) and we will aim to address your requests in future releases. This documentation is for 23.0 (released with Oasys Suite 23.0). A record of all releases is listed below.

Workflows Releases

Date	Release	Description	Documentation	Minimum required version	Download	Changelog
------	---------	-------------	---------------	--------------------------	----------	-----------

Workflows Releases

12 Jun 2026	23.0	<p>Many significant updates. Highlights include:</p> <ul style="list-style-type: none"> • New Airbag Toolbox to help you understand CPG and CPM airbag behaviour • New HBM Assessments postprocessing workflow • New Utilisation Workflows: General Utilisation, Adhesive Utilisation, Fastener/Spotweld Utilisation • New MPDB Compatibility Assessment workflow • Support for the latest Virtual Testing protocols: <ul style="list-style-type: none"> ○ IIHS Whiplash Prevention Evaluation 2025 ○ Euro NCAP 2026 	Workflow Tools 23.0	23.0		Version 23.0 Changelog
17 Dec 2025	22.1	<p>Many significant updates. Highlights include:</p>	Workflow Tools 22.1	22.0	Oasys Suite 22.1 download	Version 22.1 Changelog



Workflows Releases

		<ul style="list-style-type: none">• Updates to Automotive Assessments and SimVT to support Euro NCAP 2026 Frontal Impact and C-NCAP Management Regulation (2024 Edition)• New SimVT diagnostic tools to help you quickly pinpoint the causes of poor correlation• The LS-DYNA to ISO-MME tool can now get mass information from the d3hsp/OTF file without the need of the d3thdt file• Head offset curves from C-NCAP test video data can now be imported from CSV in SimVT• Added a "Use dv/dt" option to derive accelerations from velocity curves (instead of raw acceleration output) for use in Automotive assessments, SimVT and LS-				
--	--	---	--	--	--	--



Workflows Releases

		<p>DYNA to ISO-MME</p> <ul style="list-style-type: none">• VTC Videos is now combined into a single Workflow tool for all protocols				
18 Jun 2025	22.0	<p>Many significant updates. Highlights include:</p> <ul style="list-style-type: none">• Chinese language support in C-NCAP REPORTER templates• Easily configure the units, polarity and scale of imported ISO-MME or CSV data• Better handling of time offsets between simulation and test data• Support for new Automotive Assessments protocols, including UN ECE and Global NCAP• An upgraded Pulse Index Workflow with better usability• Enhancements to VTC Videos including target video file size	Workflow Tools 22.0	22.0	No longer available	Version 22.0 Changelog



Workflows Releases

		<ul style="list-style-type: none"> VTC Quality Criteria Workflows with support for draft Euro NCAP Frontal and HBM protocols 				
21 Nov 2024	21.1	<ul style="list-style-type: none"> Added support for C-NCAP Far Side Occupant Protection Protocol (2024 Edition) Migrated the IIHS and US NCAP automotive library templates from REPORTER to the Workflows framework Several bug fixes 	Workflow Tools 21.1	21.1	No longer available	Version 21.1 Changelog
27 Aug 2024	21.0 W1	21.0 Workflows Update 1 – Comprehensive support for Euro NCAP Virtual Far Side Protocol v1.0	Workflow Tools 21.0 W1	21.0	No longer available	Version 21.0 W1 Changelog
15 May 2024	21.0	First version containing Virtual Testing tools	Workflow Tools 21.0	21.0	No longer available	Oasys 21.0 Release Notes
08 Nov 2023	20.1	Bug fix release	Workflow Tools 20.1	20.1	No longer available	Oasys 20.1 Release Notes
17 Apr 2023	20.0	First release of Workflows	Workflow Tools 20.0	20.0	No longer available	Oasys 20.0 Release Notes





20. Timeout Control

A configurable time limit can be set that determines when REPORTER will shut down automatically. The duration can be controlled through the OASYS_TIMEOUT environment variable. Set the value of OASYS_TIMEOUT environment variable to any positive integer (measured in seconds). Once this threshold is reached, the program exits in a safe manner.



21. Appendices

21.1. A. Command Line Arguments and oa_pref Options

21.1.1. Command Line Arguments

Command line arguments

The following command line arguments are available in REPORTER . Unless stated otherwise, all command line options are evaluated in the order that they are given.

Argument	Description
<code>file.orr</code> or <code>-file=file.orr</code>	Opens REPORTER file "file.orr"
<code>-pdf=file.pdf</code>	Creates a pdf file "file.pdf"
<code>-html=file.html</code>	Creates a HTML file "file.html"
<code>-print=printer</code>	Prints report to printer
<code>-</code> <code>varNAME[!#][::type]=value[::description]</code>	Creates a variable "NAME" in REPORTER with value "value" and description "description". <code>::description</code> and <code>::type</code> can be omitted. If the type is omitted it defaults to "General". By default variables defined on the command line will not be marked as temporary. If the variable name is suffixed by '#' then the variable will be temporary. '!' can also be used to mark the variable as not being temporary (although this is not needed as it is the default).
<code>-pptx=file.pptx</code> (or <code>-ppt=file.pptx</code>)	Create PowerPoint file "file.pptx".
<code>-log=logfile</code>	Save the logfile REPORTER produces in the file "logfile" as plain text after processing all the command line options.
<code>-loghtml=logfile</code>	Save the logfile REPORTER produces in the file "logfile" as



	HTML after processing all the command line options.
<code>-generate</code>	Generate a report (previously read with <code>-file</code> argument). Note: this is not required if you use any of the <code>-ps</code> , <code>-pdf</code> , <code>-html</code> , or <code>-pptx</code> options (they do this automatically)
<code>-report=file.orr</code>	Saves generated report (previously read with <code>-file</code> argument) to <code>file.orr</code>
<code>-script=script.js</code> <code>-js=script.js</code>	Runs JavaScript script <code>script.js</code> .
<code>-js_arg="passing a sentence"</code>	Defining an argument to be used in JavaScript files. Multiple arguments can be given to a script by using more than one <code>-js_arg</code> command line argument. The arguments can be accessed in the script by using the global <code>arguments</code> array. Note: The first argument in the <code>arguments</code> array will by default always be the file path of the script being run.
<code>-argfile=argfile</code>	Reads command line arguments from file <code>argfile</code> , one argument per line. This could be useful if you want to read lots of variables on the command line and you reach the command line length limit.
<code>-exit</code>	Automatically exit after processing all other command line options
<code>-iconise</code>	Start REPORTER iconised. This is useful for running reporter from



	scripts when you want to continue working on something else and you do not want the REPORTER window to interfere.
<code>-new</code>	Create a new template.
<code>-batch</code>	Batch mode. This stops REPORTER prompting the user. For example, normally if an error occurs when generating REPORTER brings up a warning box allowing the user to look at the error. Giving the <code>-batch</code> argument stops this. Note that this does NOT make REPORTER run without the user interface (see <code>-iconise</code>)
<code>-oasys_batch</code>	On Windows run D3PLOT and T/HIS without any windows being shown.
<code>-combine</code>	Combine multiple report output into pdf, html or pptx.

So for example:

```
reporter -file=/job/templates/example.orrx /
        -pdf=/local/output.pdf /
        -print=printer /
        -varKEYWORD=/job/keyword/example.key::example deck /
        -html=/local/example.html /
        -exit
```

Will:

1. Load the file "/job/templates/example.orr" into REPORTER
2. Install a variable called KEYWORD with value "/job/keyword/example.key" and description "example deck"
3. Create a pdf file "/local/output.pdf"
4. Print the file on printer "printer"
5. Create a HTML file "/local/example.html"
6. automatically exit

21.1.2. Oa Pref Options

21.1.2.1. The "oa_pref" Preferences File



The "oa_pref" preferences file.

This file contains code-specific preferences that can be used to modify the behaviour of Oasys LS-DYNA Environment products. It is optional and, where entries (or the whole file) are omitted REPORTER will revert to its default settings.



21.1.2.2. "oa_pref" Naming Convention and Locations

"oa_pref" naming convention and locations

The file is called "oa_pref"

It is looked for in the following places in the order given:

- The site-wide admin directory (`$OA_ADMIN`)
- The site-wide " Oasys Ltd LS-DYNA Environment " directory (`$OA_INSTALL`)
- The user's home directory: `$HOME` (Unix/Linux) or `$USERPROFILE` (Windows)

The first encountered file will be used, so this file can be customised for a particular job or user at will.

Files do not have to exist in any of these locations, and if none exists the programme defaults will be used.

On Unix and Linux:

`$HOME` on Unix and Linux is usually the home directory specified for each user in the system password file.

The shell command "`printenv`" (or on some systems "`setenv`") will show the value of this variable if set.

If not set then it is defined as the "`~`" directory for the user. The command "`cd; pwd`" will show this.

On Windows:

`$USERPROFILE` on Windows is usually `c:\Documents and Settings\ <user id> \`
Issuing the "`set`" command from an MS-DOS prompt will show the value of this and other variables.

Generally speaking you should put

- Organisation-wide options in the version in `$OA_INSTALL`,
- User-specific options in `$HOME / $USERPROFILE`



21.1.2.3. "oa_pref" File Syntax

"oa_pref" file syntax

The syntax used for PRIMER is:

```
reporter*<keyword>: <argument>
```

for example:

```
reporter*default_item_width: 10.0
```

The rules for formatting are:

- The `<programme>*<option>`: string must start at column 1;
- This string must be in lower case, and must not have any spaces in it.
- The `<argument>` must be separated from the string by at least one space.
- Lines starting with a " # " are treated as comments and are ignored.



21.1.2.4. "oa_pref" Options Valid for REPORTER

"oa_pref" arguments valid for REPORTER

Preference	Type	Description	Valid arguments	Default
date_format	<string>	Format for printing default date variable	Day Month Day Year, dd/mm/yyyy, mm/dd/yyyy, yyyy/mm/dd	Day Month Day Year
default_item_height	<real>	Default width given to item (mm) if it is not dragged when creating	0.0 - 999.9	10.0
default_item_width	<real>	Default height given to item (mm) if it is not dragged when creating	0.0 - 999.9	10.0
file_names	<string>	Controls output file names. LSTC = d3plot, d3thdt, d3hsp etc, OASYS/ARUP = job.ptf, job.thf job.otf etc	OASYS, ARUP, LSTC	OASYS
maximise	<logical>	Maximise window when REPORTER started	TRUE, FALSE	TRUE
oasys_batch	<logical>	Run D3PLOT, PRIMER and T/HIS in batch mode from REPORTER	TRUE, FALSE	FALSE
placement	<string>	Location for initial window on multi-screen display	LEFT, CENTRE, RIGHT, BOTTOM, TOP, LEFT_BOTTOM, LEFT_TOP, CENTRE_BOTTOM, CENTRE_TOP, RIGHT_BOTTOM, RIGHT_TOP	<none>
save_colours_on_exit	<logical>	Automatically save the user colours XML file when the program exits.	TRUE, FALSE	TRUE
start_in	<string>	Directory to start REPORTER in		<none>
time_format	<string>	Format for printing default time variable	hh:mm:ss, hh:mm:ss A, hh:mm, hh:mm A	hh:mm:ss



use_default_vars	<logical>	Use default vars in filenames when capturing if possible	TRUE, FALSE	TRUE
use_file_vars	<logical>	Use file/directory vars in filenames when capturing if possible	TRUE, FALSE	TRUE

The following control whether and how crash dump information is sent by email following a crash

Preference	Type	Description	Valid arguments	Default
cd_compose_email	<logical>	Whether or not to offer to compose an email for sending minidump files.	TRUE, FALSE	TRUE
cd_email_address	<string>	Email address in To: field of crash dump emails.		dyna.support@arup.com
cd_cc_addresses	<string>	Email address(es) in Cc: field of crash dump emails.		<none>
cd_custom_email	<string>	Custom method of sending emails.		<none>
cd_dump_directory	<string>	Directory in which to save crash dump files		<none>
cd_email_method	<string>	Method used to create crash dump emails.	BEST_EFFORT, SYSTEM_DEFAULT, OUTLOOK_CLI, URL_MAILTO, CUSTOM	BEST_EFFORT



cd_minidump_file	<string>	Whether or not to create minidump files, and what to do with them.	NOT_USED, SAVED_ONLY, EMAILED_ONLY, SAVED_AND_EMAILED	SAVED_AND_EMAILED
------------------	----------	--	---	-------------------

The following options control font settings in REPORTER

Preference	Type	Description	Valid arguments	Default
default_fonts				
cursive_font	<string>	Default cursive font in REPORTER		'Monotype Corsiva' [Windows]; 'URW Chancery L' [Linux]
fantasy_font	<string>	Default fantasy font in REPORTER		'Impact' [Windows]; 'Impact' [Linux]
monospace_font	<string>	Default monospace font in REPORTER		Courier New [Windows]; Courier 10 Pitch [Linux]
sans_serif_font	<string>	Default sans-serif font in REPORTER		'Arial' [Windows]; 'Liberation Sans' [Linux]
serif_font	<string>	Default serif font in REPORTER		'Times New Roman' [Windows]; 'Nimbus Roman No9 L' [Linux]
symbol_font	<string>	Default symbol font in		'Symbol' [Windows]; 'Standard Symbols L' [Linux]



		REPORTER		
blacklisted_fonts	<string>	Comma-separated list of font filenames that will not be processed by REPORTER because they typically take too long to load		<none>
cache_directory	<string>	Font cache file directory		\$OA_HOME
font_mapping_table	<string>	Full path and filename of font mapping table CSV file		\$OA_INSTALL/reporter_library/fonts/font_mapping.csv

The following options control graphical user interface

Preference	Type	Description	Valid arguments	Default
group_tools	<logical>	Group the Tool buttons into a single button for each category	TRUE, FALSE	FALSE
gui_theme	<string>	Graphical User Interface (GUI) theme	LIGHT, DARK, CLASSIC, LEGACY	LIGHT
show_labels	<logical>	Show labels as well as icons on the Tool buttons	TRUE, FALSE	FALSE



The following options control grid

Preference	Type	Description	Valid arguments	Default
default_grid	<real>	Default grid spacing (mm)	0.0 - 999.9	5.0
default_snap	<real>	Default snap size (mm)	0.0 - 999.9	1.0
grid_colour	<string>	Default grid colour (HEX RRGGBB value)		A9A9A9
grid_style	<string>	Default grid line style	DOT, CROSS, LINE	DOT
show_grid	<logical>	Show grid lines on page	TRUE, FALSE	FALSE
snap_to_grid	<logical>	Snap items to grid	TRUE, FALSE	TRUE

The following options control the library location in REPORTER

Preference	Type	Description	Valid arguments	Default
library_directory	<string>	User defined library directory for REPORTER		\$OA_INSTALL/reporter_library
library_only_use_specified_directory	<logical>	Only scan location set by preference reporter*library_directory for Library templates, pages and scripts (if it is set)	TRUE, FALSE	FALSE

The following options control Logfile preferences

Preference	Type	Description	Valid arguments	Default
check_for_errors	<logical>	Check for errors during report generation	TRUE, FALSE	TRUE
debug_oasys	<logical>	Include debug information from PRIMER, D3PLOT and T/HIS	TRUE, FALSE	FALSE
stay_in_oasys	<logical>	Don't automatically exit from PRIMER, D3PLOT and T/HIS	TRUE, FALSE	FALSE

The following options control how objects are edited



Preference	Type	Description	Valid arguments	Default
coordinate_method	<string>	Method used for editing object coordinates	Opposite corners, Width and height	Width and height
default_nudge	<real>	Default nudge distance (mm)	0.0 - 999.9	5.0
object_reference_corner	<string>	Corner used as reference when editing objects	TopLeft, TopRight, BottomLeft, BottomRight	BottomLeft
revert_to_select_tool	<logical>	After creating a new item, the cursor reverts to the Select tool	TRUE, FALSE	TRUE

The following options control pdf output

Preference	Type	Description	Valid arguments	Default
image_downsampling				
pdf_image_downsample	<logical>	Downsample images in pdf files	TRUE, FALSE	FALSE
pdf_image_downsample_resolution	<integer>	Resolution to downsample images to	10 - 3000	150
pdf_image_downsample_threshold	<real>	Factor above pdf_image_downsample_resolution before downsampling is done	1.0 - 10.0	1.5

The following options control which other Oasys Ltd LS-DYNA Environment programmes are used by REPORTER

Preference	Type	Description	Valid arguments	Default
d3plot	<string>	D3PLOT executable to use		<none>
d3plot_args	<string>	Extra command line arguments to pass to D3PLOT		<none>
d3plot_properties_parts_only	<logical>	Only read parts (ignore elements) when reading properties file	TRUE, FALSE	FALSE



d3plot_properties_pre_blank	<logical>	Pre blank all parts before reading properties file	TRUE, FALSE	FALSE
primer	<string>	PRIMER executable to use		<none>
primer_args	<string>	Extra command line arguments to pass to PRIMER		<none>
this	<string>	T/HIS executable to use		<none>
this_args	<string>	Extra command line arguments to pass to T/HIS		<none>

The following options control unicode

Preference	Type	Description	Valid arguments	Default
cjk_default	<string>	Default language for ambiguous CJK Kanji	Chinese, Japanese, Korean	Japanese
pdf				
chinese_characters	<string>	Style for chinese characters in pdf files	Simplified, Traditional	Traditional
japanese_font	<string>	Font for japanese characters in pdf files	Kozuka Mincho Pro, Kozuka Gothic Pro	Kozuka Mincho Pro



21.1.2.5. Editing/Changing Preferences

Editing/changing preferences

There is currently no interactive preferences editor for REPORTER . To change preferences for REPORTER please use the interactive preferences editor in Oasys SHELL, D3PLOT, T/HIS or PRIMER or edit the preferences file by hand.



21.2. B. Library Objects

21.2.1. Standard Library Programs

Standard library programs

REPORTER has a number of built-in scripts to retrieve data from the keyword or otf files. New scripts can be added as required. See [Adding scripts to the library](#). By default, REPORTER looks for library programs in the subdirectory `reporter_library/scripts` in the directory where REPORTER is installed. Other directories can be added if required. See [Preferences → Library](#) for more details.



21.2.1.1. D3PLOT Data File Programs

D3PLOT data file programs

Create a D3PLOT data file from a cvs file	Create a data file which is suitable for use by D3PLOT . The data will be extracted from a csv (comma separated value) file. See Using datafiles to create 'blob' plots
Create a D3PLOT data file from generated data files	Create a data file which is suitable for use by D3PLOT . The data will be extracted from <code>reporter_variables</code> files. See Using datafiles to create 'blob' plots.



21.2.1.2. Eigout File Programs

Eigout file programs

Extract eigenvalues (modal frequencies) from eigout file	Extracts eigenvalues (modal frequencies) from the eigout file produced by Ansys LS-DYNA during modal analysis.
---	--



21.2.1.3. Error Programs

Error programs

Read PRIMER error file	Read an error file produced by doing a model check in PRIMER and extract the errors
-------------------------------	---



Keyword file programs

The following programs retrieve information from a keyword file.

Analysis title	Prints the title of the analysis from the *TITLE card.
Comments between *KEYWORD and *TITLE	Prints any comment lines in the keyword file between the *KEYWORD and *TITLE keywords. The \$ will be removed from each line. An optional second argument can be used to impose a maximum limit on the number of lines printed.
Create variables for parameters used in analysis	
Extract title and LCSS curve from *MAT_PIECEWISE_LINEAR_PLASTICITY_TITLE cards	
Include files used in analysis	Prints a list of all the include files used in the analysis. By default the full pathname of include files is written. An optional second argument can be used to give the names relative to the master file
Initial velocity card used in analysis	Prints the first line of any *INITIAL_VELOCITY cards in the keyword file. The script will also recursively look in include files for *INITIAL_VELOCITY cards.
Timestep from *CONTROL_TIMESTEP card	Reads the DT2MS value from the *CONTROL_TIMESTEP card



21.2.1.5. NCAP

NCAP programs

Create a US-NCAP graph	Create a graph for US-NCAP star rating using HIC and chest acceleration (3ms clip)
-------------------------------	--



OTF file programs

The following programs retrieve information from an OTF file.

Mass info

Added mass at end of analysis	Prints the mass added to the analysis by mass-scaling at the end of the analysis. This will also look at otf files generated from restarts (otf01, otf02 etc)
Added mass at start of analysis	Prints the mass added to the analysis by mass-scaling at the start of the analysis.
Percentage final added mass	Prints the percentage mass added to the analysis by mass-scaling at the end of the analysis. This will also look at otf files generated from restarts (otf01, otf02 etc)
Percentage initial added mass	Prints the percentage mass added to the analysis by mass-scaling at the start of the analysis.
Total mass in analysis	Prints the mass of the model at the start of the analysis

Timestep info

Mass-scaled timestep (DT2MS) echo in OTF file	Prints the DT2MS value from the *CONTROL_TIMESTEP card echoed to the OTF file.
Smallest initial timestep	Prints the element with the smallest timestep from the 100 smallest timesteps. The line has the form: <element_type> <element_number> timestep = <timestep>

Timing info

Elapsed time for analysis	Prints the total elapsed time for the analysis.
Start time for analysis	Prints the date and time that the analysis finished.
Problem cycle for analysis	Prints the cycle in the analysis that the problem terminated.



Problem time for analysis	Prints the time in the analysis that the problem terminated.
Start time for analysis	Prints the date and time that the analysis started (same as Analysis date).
Termination time(ENDTIM) echo in OTF file	Prints the termination time from the *CONTROL_TERMINATION card echoed to the OTF file. This will also look at otf files generated from restarts (otf01, otf02 etc).

Other OTF programs

Analysis date	Prints the date and time that the analysis started
Analysis precision	Prints the precision (single/double) Ansys LS-DYNA used for the analysis
Analysis title	Prints the title of the analysis echoed to the OTF file.
CPU time for analysis	Prints the total CPU time used for the analysis. This will also look at otf files generated from restarts (otf01, otf02 etc)
Check on the quality of the run	Looks to see if the analysis terminated normally, if the initial and final added masses, the total energy fluctuation and hourglass energy are below (user definable) limits. Either prints OK or NOT OK.
Hostname analysis run on	Prints the hostname of the machine the analysis was run on.
Ansys LS-Dyna version and revision	Prints the version and revision of Ansys LS-DYNA used to run the analysis
Normal or Error termination message	Prints Normal or Error termination message from Ansys LS-DYNA.
Number of CPUs used for analysis	Prints the number of CPUs used for the analysis
OS analysis run on	Prints the operating system level of the machine the analysis was run on.
Platform analysis	Prints the platform of the machine the analysis was run on.



21.2.1.7. Variables

Variables programs

Delete all temporary variables	Delete all temporary variables in the REPORTER template
Read a REPORTER variable file	Read a variables file written by another REPORTER template and install the variables from it into the current template
Read variables from a CSV file	Read variables from a CSV file (one variable per row).
Read variables from a CSV file (data in rows)	Read variables from a CSV file (one variable per column)
Reset all temporary variables to a specified value	Reset temporary variables to a specified value (default is an empty string)
Write variables to a	Write variables to a variables file



21.2.2. Standard Library Pages

Standard library pages

REPORTER comes with some standard pages which can be installed from a library. They are shown in the image below. The pages are available in landscape and portrait versions. The information on the page is the same in either case.

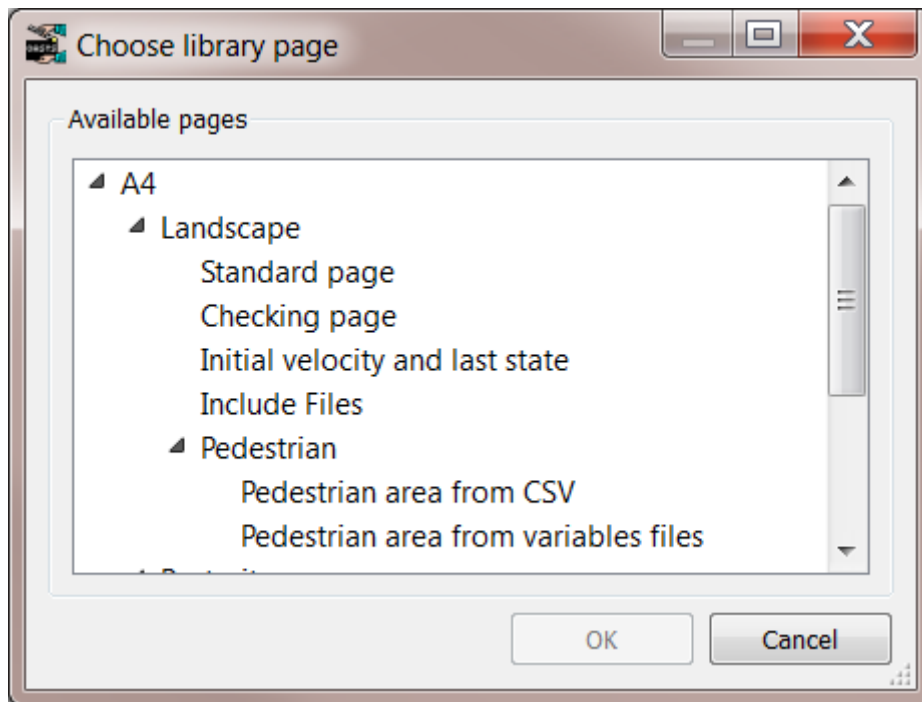

Type	Description
Checking page	Information for the analysis extracted from the OTF file and an energy balance plot from T/HIS .
Include Files	A list of any include files that were used in the analysis
Initial velocity and last state	Images captured from D3PLOT of the initial velocity in the analysis and of the last state.
Standard page	A blank page with a standard footer

New pages can be added as required. See [Adding pages to the library](#).

21.2.3. Standard Library Images

Standard library images



REPORTER comes with some standard images which can be installed from a library. They are shown in the image below.

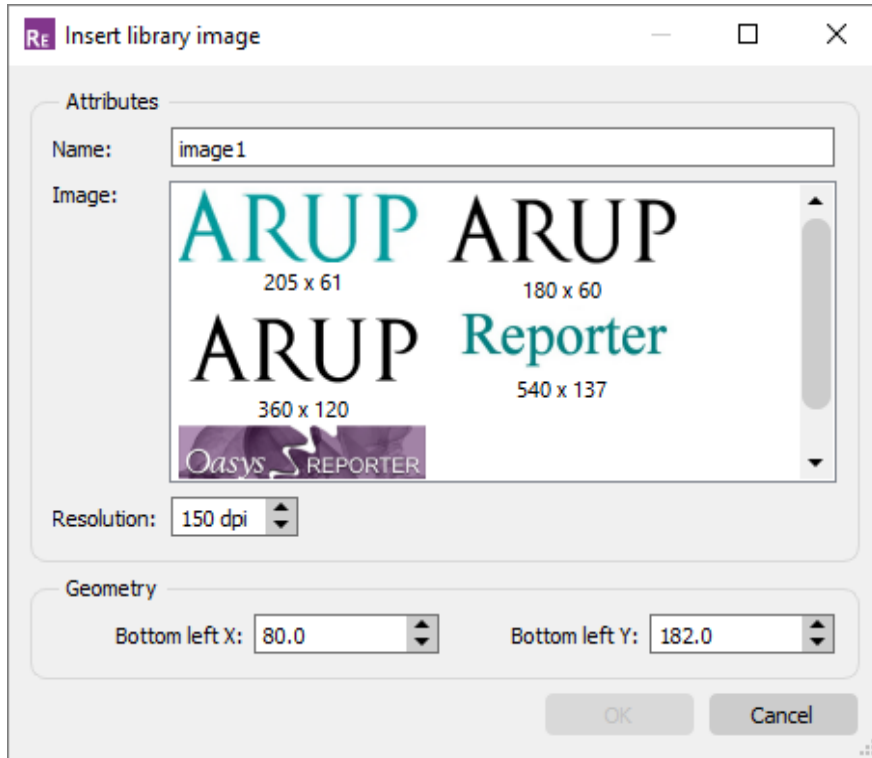

New images can be added as required. See [Adding images to the library](#).

21.2.4. Adding Pages to the Library

Adding pages to the library

To add a new page layout to the library you need to:

- Create a the page in REPORTER .
- Export the page, saving it with extension `.orp` using Page->Export... (see [exporting pages](#) for more details).
- Copy the exported page into the `/library/pages/` directory of your Oasys LS-DYNA Environment installation.

It will then be shown the next time you start REPORTER . Note that the title of the page is what will be shown in the library page tree so make sure that the page has a sensible title. This can be changed using Page->properties... (see [Changing the page properties](#) for more details).

So, for example, if you have a page called 'New library page' and you put it in the `/library/pages/` directory you will get:

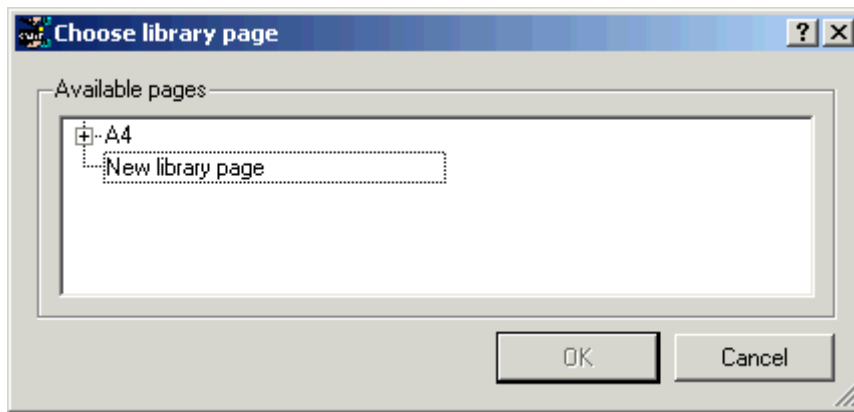

If you want the page to be shown in a different branch of the tree then edit the file using a text editor and change the file as follows. The first line should look like:

```
<REPORTER FILETYPE='page' VERSION='92'>
```

If I wanted a branch in the tree to be 'Arup/Example library pages/portrait' I would change this to

```
<REPORTER FILETYPE='page' VERSION='92' FOLDER='Arup/Example library pages/portrait'>
```

The page would then be shown in the tree as:

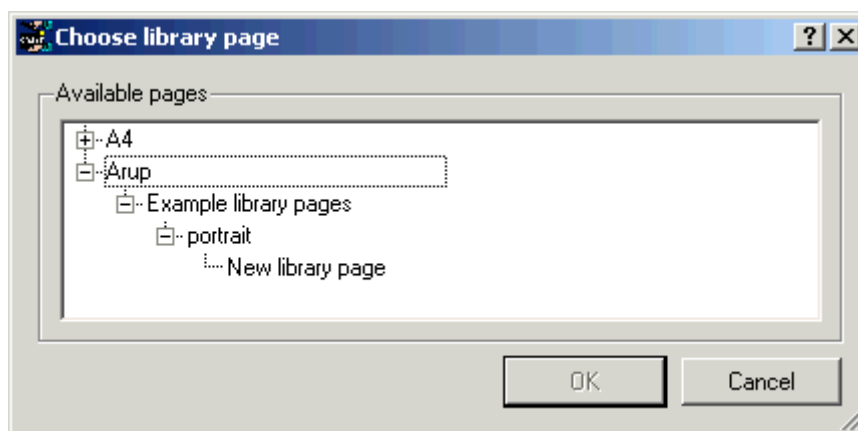

21.2.5. Adding Scripts to the Library

Adding Scripts to the library

REPORTER has a JavaScript interpreter built into it. The scripts which are available in the library are run inside REPORTER.

To add a new script to the library save it into the `scripts` directory of your [Library](#). Then you need to add the following special comment at the top of the file:

```
/* A description of your script
```



```

PROGRAM::<script_name>
DESC::<description>
FOLDER::<folder> (optional)
RETURN::<output_type>
[+-]ARG::<description>[:<default text>] (repeat for as many
arguments as required)
EXPAND_ARGS::false (optional)
END_INFO
*/

```

Note the /* at the beginning and */ at the end.

The lines have the following meaning:

PROGRAM	<script_name> is the name of the JavaScript program. It should have the extension js
DESC	<description> is a description of the program/script that will appear in the Insert program from library window
FOLDER	The programs in the Insert program from library window are shown in a 'tree' view. <folder> indicates which folder or 'branch' of the tree the program is shown in. This is the same as for library pages above.
RETURN	<output_type> is the type of output the program returns. Currently the only value supported is text .
ARG	<description> is the argument description that will appear in the Insert program from library window. Optionally the line can be prefixed with a + or - sign. If a - sign is used the argument is optional. If a + sign is used (default) the argument is mandatory. Optionally an argument can be followed by <default_text> which will be used as a default for the argument in the window.
EXPAND_ARGS	Normally any variables in program arguments get expanded to their actual values and so you would omit this line. There may be instances where you do not want to expand them. In this case use the line <code>EXPAND_ARGS::false</code> (e.g. see <code>data_file_from_variables.js</code>).
END_INFO	This line indicates the end of the informat and must be included

For example, the following lines

```

/*
PROGRAM::example.js
DESC::Example program
FOLDER::examples/programs
RETURN::text
ARG::argument1::default1
ARG::argument2
-ARG::argument3::default3

```



END_INFO
*/

would give the output:

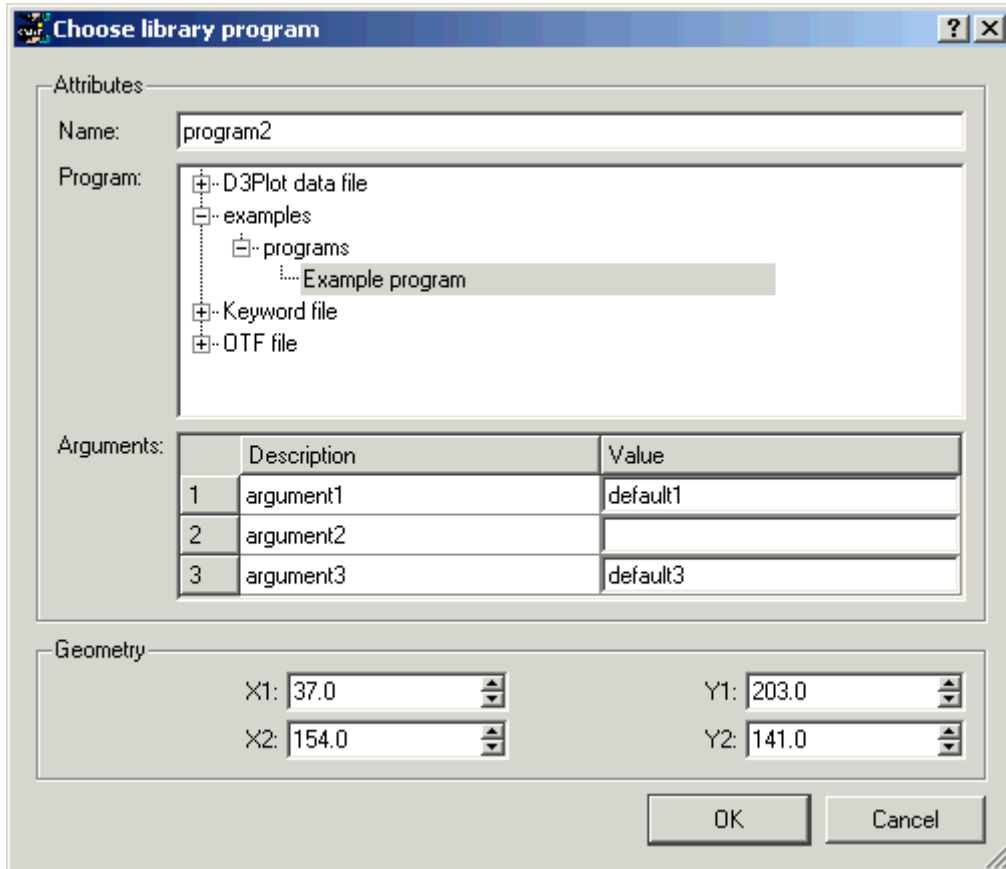



21.2.5.1. Rules for Writing Scripts

Rules for Writing Scripts

As REPORTER runs the scripts internally, they have to be written in a specific way. The following guidelines should be used for writing custom scripts for REPORTER. If these guidelines are too restrictive or you do not want to work this way, remember that you can write external programs for REPORTER in any language you choose. See [Appendix D](#) for more details.

- Scripts must be written in JavaScript! REPORTER contains a JavaScript interpreter. Other languages are NOT supported.
- To output text back to REPORTER, use the output function.
- See the [scripting](#) chapter for JavaScript scripting.
- See the JavaScript reference manual for extra JavaScript classes that REPORTER defines.

The scripts in the `/library/scripts` directory give an indication of what is possible with internal scripts. For more details refer to the individual scripts.

The functionality will be extended over time. If you have requests for new features, contact Oasys Ltd Support.

21.2.6. Adding Images to the Library

Adding images to the library

To add an image to the library copy it into the `/library/images` directory of your Oasys LS-DYNA Environment installation. It will then be shown next time you start REPORTER. The image should be a bmp, jpg, png or gif image.

Note that if you add images to the library and then use the image in a template, the image will not work for installations that do not have this library image. This is fine if you are using this internally in your company, but be careful when giving a template to another person/company. The way round tis problem is to save your template as a report once it has been generated. When you save as a report any images are embedded to this is then portable. See [Outputting a generated report](#) for more details.

21.2.7. Standard Library Templates

Standard library templates

A number of standard templates have been created for automotive crash test protocols, included as part of the installation. They are located in the subdirectories `reporter_library/templates`



and `workflows/templates/automotive_assessments` in the directory where REPORTER is installed.

The templates in the `workflows/templates/automotive_assessments` directory are new in Oasys 21.0 and use data saved from the [Automotive Assessment workflow](#). Guidance for these templates can be found in the [Automotive Assessments REPORTER](#) section.

The templates in the `reporter_library/templates` directory use the original method of using data stored in CSV files. The following sections discuss how to use these templates.

The templates can be selected from **File Open Library Template...**. After asking a few questions to get information needed to generate the report, the standard templates calculate results according to the protocol, e.g. EuroNCAP Front Impact. They can also be run in a [batch](#) mode. In addition to the standard templates for automotive crash test protocols, there is a general Ansys LS-DYNA template that can be used for any Ansys LS-DYNA model, and a general Ansys LS-DYNA vehicle template that can be used for any vehicle analysis.

In general, the templates contain a front summary page showing the overall score for the test, with further pages containing tables showing individual measurements and graphs.

The reports can be written out as PDF, HTML or PPTX files as normal.

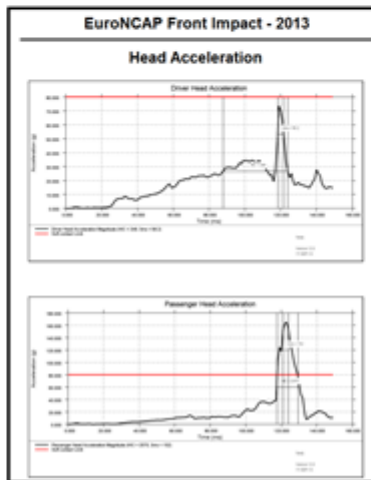
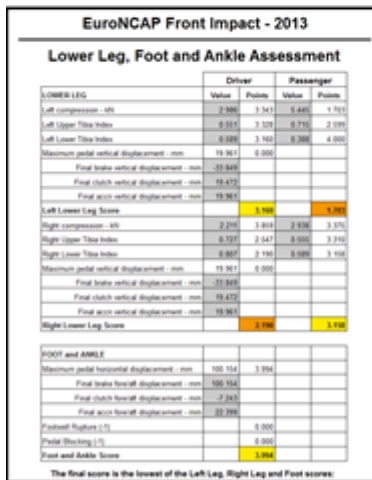
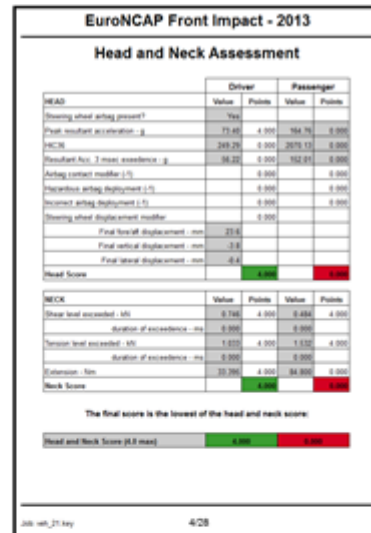
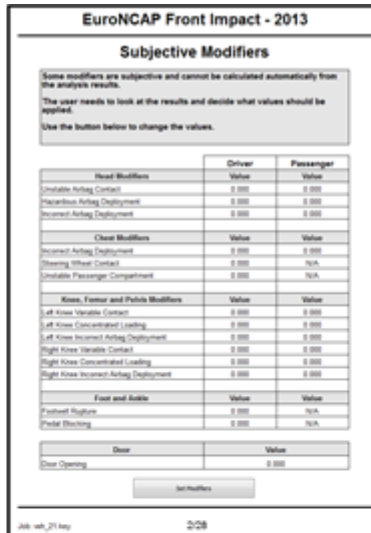
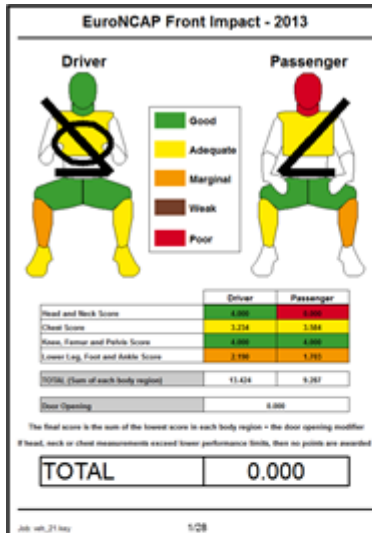

There are two generic - types of templates:

- [Single analysis templates](#) (Front Impacts, Side Impacts...)
- [Multiple analysis templates](#) (Pedestrian Head Impacts, Pedestrian Leg Impacts)

The way they work is slightly different, but generally they follow the same process. The following sections will describe how to use the templates. There is also additional documentation for the new Euro NCAP MPDB templates:

Euro NCAP MPDB Compatibility Assessment 2020 and 2023

- [REPORTER Instructions](#)
- [Barrier face deformation calculation](#)
- [Occupant Load Criterion calculation](#)



21.2.7.1. The Latest Templates

The latest templates

We are in the process of migrating the REPORTER library templates to the [Workflows framework](#)



21.2.7.2. Assumptions

Assumptions

The following assumptions are made about the models to be post-processed. If they are not true of your model then the templates may not work correctly:

- Humanetics dummies should be used for any occupants.
- Intrusion measurements are made with springs.

Use `*ELEMENT_DISCRETE` with a low stiffness value on the `*MAT_SPRING_ELASTIC` card.

Node 1 should be attached to the structure that is being measured and Node 2 should be attached to a nodal rigid body where there will be no deformation (normally at the rear of the vehicle). For example, to measure the steering column intrusion in an ODB impact:

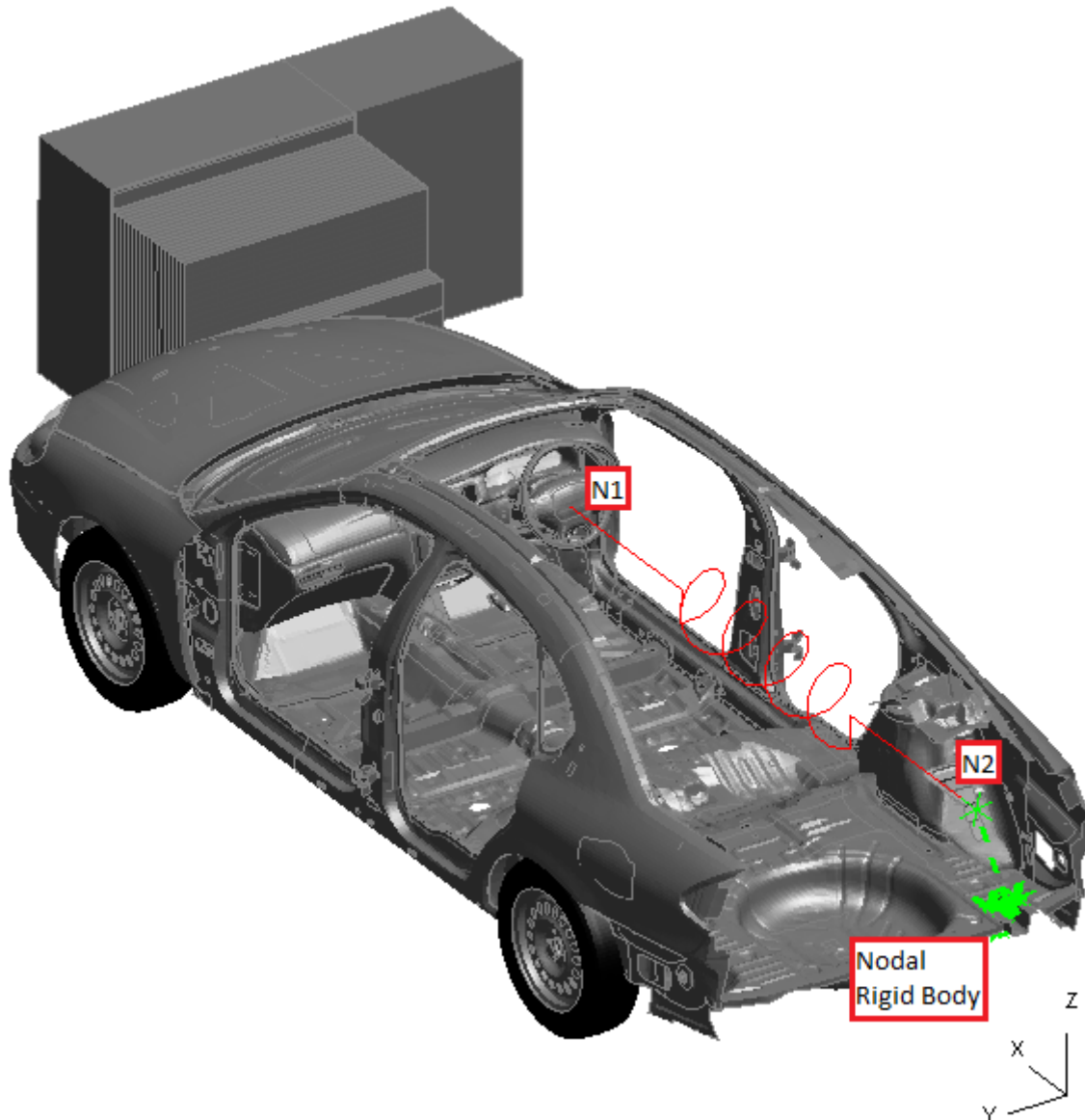

One spring will be needed for each intrusion measurement. For the case above there are three springs overlaying each other: one for intrusions in X, one in Y and one in Z. A vector should be used to define the orientation and should be aligned with the X, Y or Z global axis depending on the measurement being made.



21.2.7.3. Single Analysis Templates

Single analysis templates

All the single analysis templates follow the same process, so we'll use the EuroNCAP Front ODB Impact template as an example for how to use them. The section will describe how to run them interactively using the menus in REPORTER, but it is also possible to run them in [batch](#) mode.

Select the template

Use the **File** → **Open Library Template** menu and select a template from the **Automotive** tab (see [Reading an existing template or report](#) for more details).

Generate the template

After selecting the template REPORTER should prompt you to select the keyword file of the job you want to post-process:

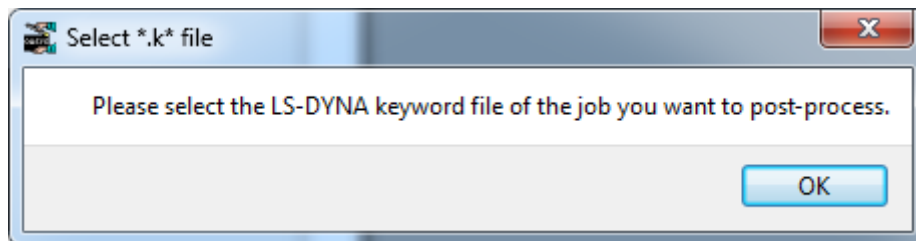

After pressing 'OK' a file selector is mapped for you to select the keyword file.

In order to correctly extract the results needed for the protocol the template needs model information such as Node IDs, Beam IDs, the unit system, etc. This needs to be supplied to the template either from a .CSV file or from comments written in the keyword file after the *END keyword. The template will help you to create this information (***you should only need to do this ONCE for a particular vehicle programme so long as IDs remain the same***).

The template will scan the keyword file to see if it contains the required information after the *END keyword. If it does you will be asked if you want to use it:

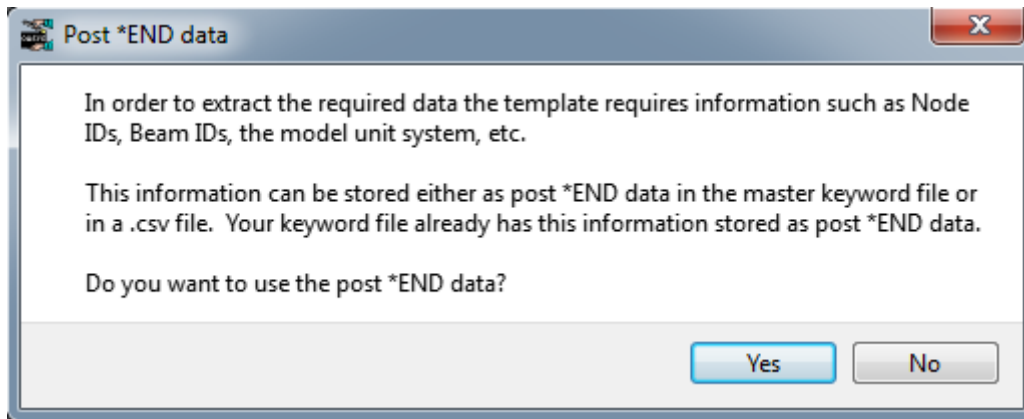

If you press 'Yes' then the next few questions will not be asked.

If you press 'No' or the keyword file doesn't contain the required information after the *END keyword you will be asked if you have a .CSV file with the information instead:

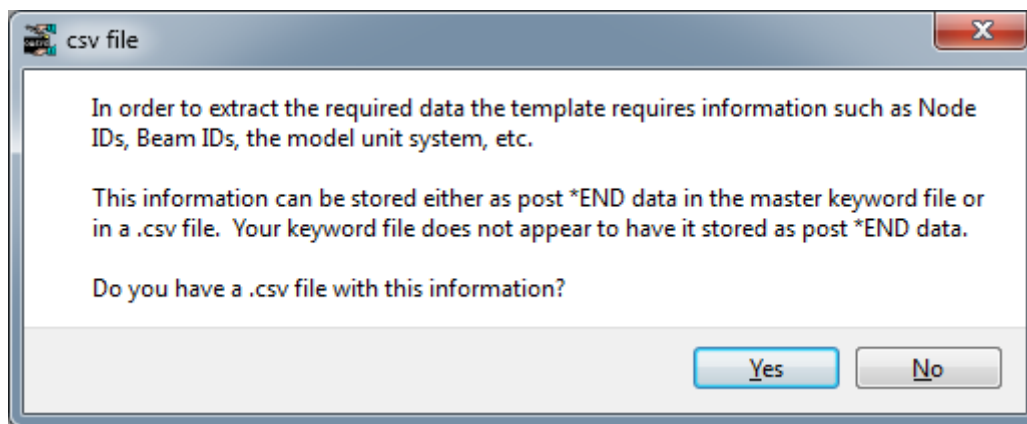

If you have a .CSV file, press 'Yes' and select it in the file selector.

If you press 'No' REPORTER will inform you that it will start PRIMER so you can select the required information interactively:

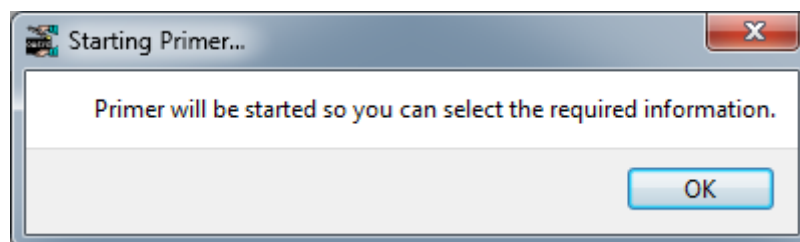

After pressing 'OK' PRIMER will start, the model will be read in and a window will be open for you to interactively select the required information:

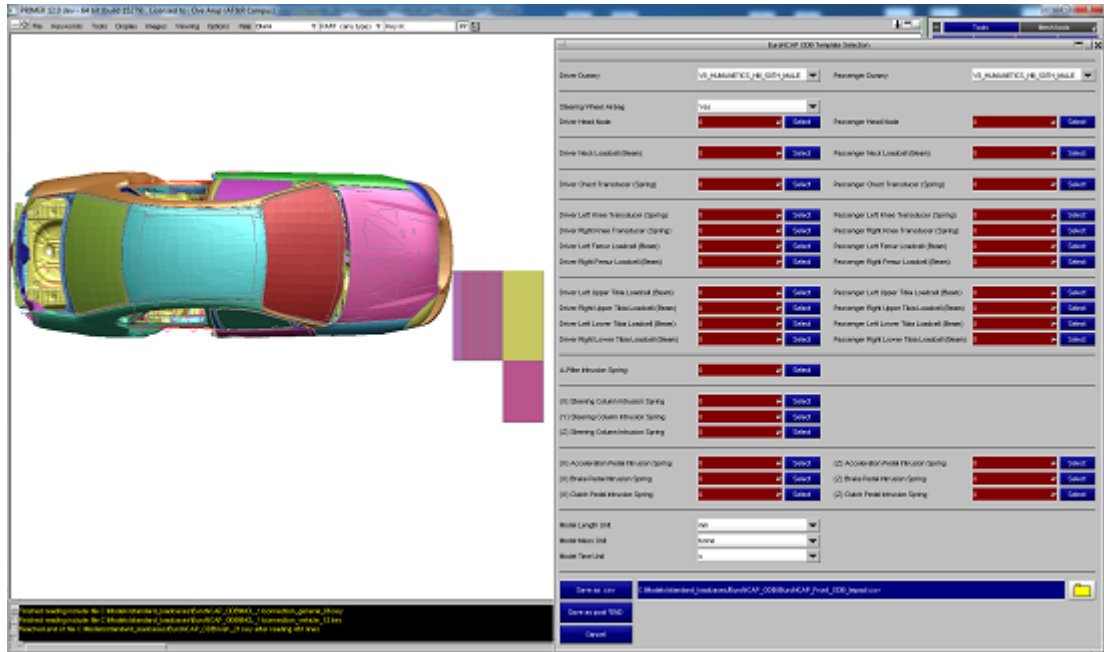

You can select the information either by picking the entities in the graphics window, typing it in to the textbox or selecting it from a list of *DATABASE_HISTORY_XXXX entities in the popup menu. If they are defined with the _ID option then the names will be used instead of the numbers, e.g.

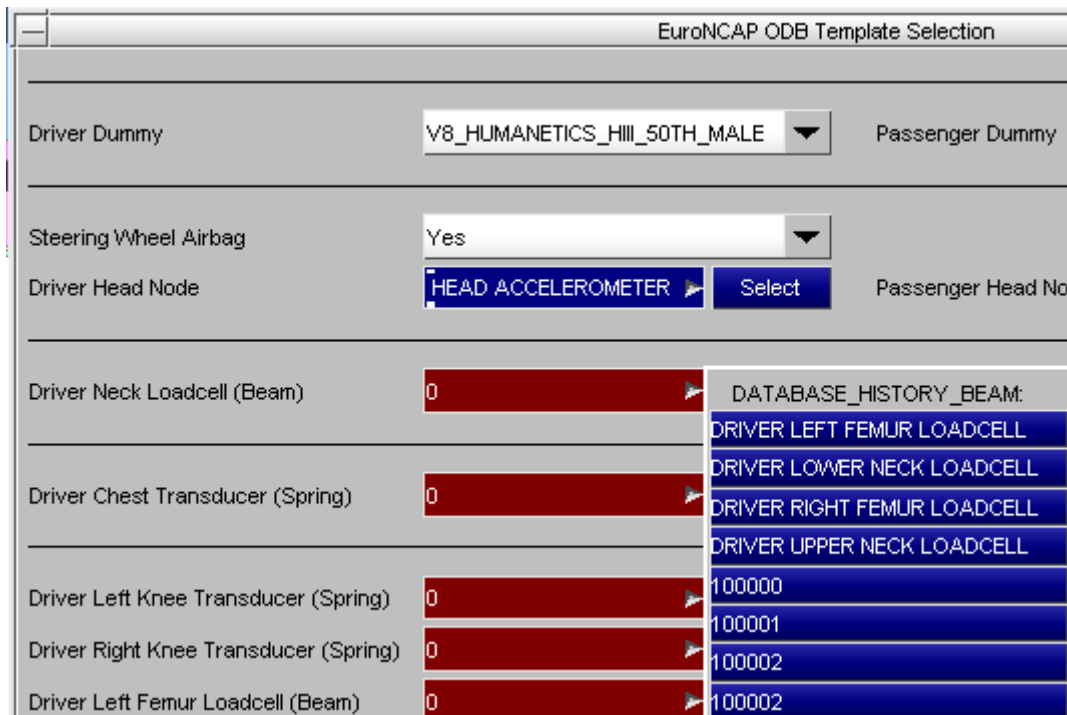

After you have selected the information you can need to save it either as a .CSV file or post *END data. Next time you use the template, perhaps on a slightly modified model, you should be able to reuse this data without having to go back into PRIMER each time (so long as the IDs of entities you want to extract data from stay the same).

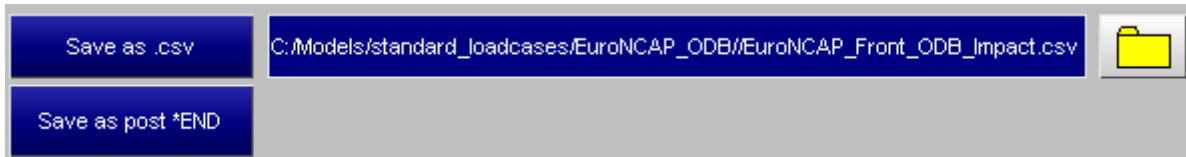

PRIMER will close and REPORTER will ask for the directory containing the analysis results (which may be different to the location of your keyword file).

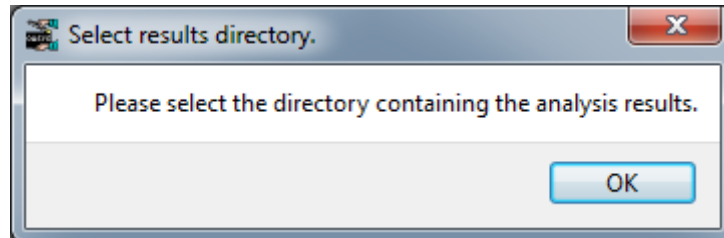

Press OK and select the directory.

Finally you will be asked for a directory where REPORTER should write any images.

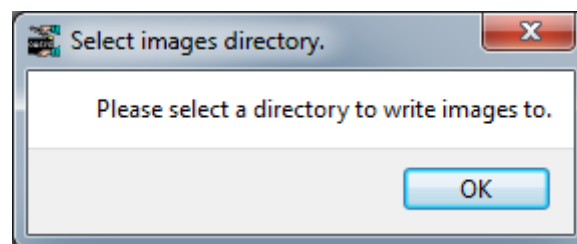

Press OK and select the directory.

REPORTER should now have all the information it needs. T/HIS will load and carry out the post-processing according to the selected protocol, generating the required graphs. Once this is finished, REPORTER will ask a final question asking you how/if you want to save the report:

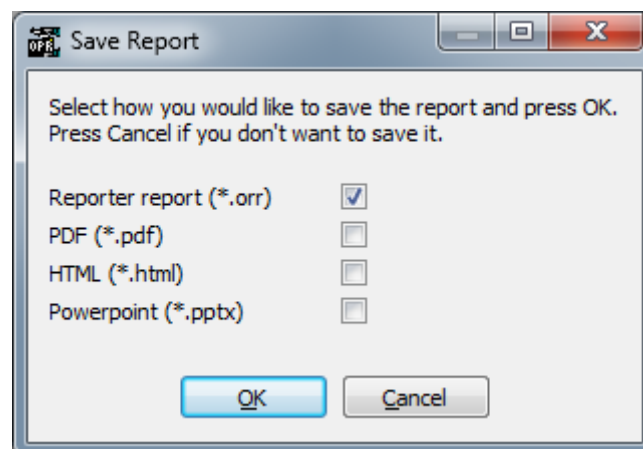

If you don't want to save the report, just press 'Cancel'. If you do, select the format(s) you want to save it in, press 'OK' and select where you want to save it in the file selector that will pop up.

The final report should look something like this, with a front summary page showing the protocol scores in tables and as an image; a page to change [subjective modifiers](#) that can't be calculated automatically from the analysis; tables and graphs showing the analysis results and protocol scores in more detail:

Subjective modifiers

In general most data can be extracted automatically from the analysis results and then processed according to the protocol. However, some data is subjective and requires the user to look at the analysis results and manually set the values.

For example, the EuroNCAP front ODB impact test has some modifiers which are applied as penalty points to the calculated scores, e.g. if an airbag doesn't deploy correctly a 1 point penalty is applied.

These subjective values can be set on the second page of the report after it has been generated. This lists all the subjective modifiers and their current value and a button to edit them:

EuroNCAP Front ODB Impact - 2014

Subjective Modifiers

Some modifiers are subjective and cannot be calculated automatically from the analysis results.

The user needs to look at the results and decide what values should be applied.

Use the button below to change the values.

	Driver	Passenger
Head Modifiers	Value	Value
Unstable Airbag Contact	0.000	0.000
Hazardous Airbag Deployment	0.000	0.000
Incorrect Airbag Deployment	0.000	0.000
Chest Modifiers	Value	Value
Incorrect Airbag Deployment	0.000	0.000
Steering Wheel Contact	0.000	N/A
Unstable Passenger Compartment	0.000	N/A
Knee, Femur and Pelvis Modifiers	Value	Value
Left Knee Variable Contact	0.000	0.000
Left Knee Concentrated Loading	0.000	0.000
Left Knee Incorrect Airbag Deployment	0.000	0.000
Right Knee Variable Contact	0.000	0.000
Right Knee Concentrated Loading	0.000	0.000
Right Knee Incorrect Airbag Deployment	0.000	0.000
Foot and Ankle	Value	Value
Footwell Rupture	0.000	N/A
Pedal Blocking	0.000	N/A

Door	Value
Door Opening	0.000



Press the 'Set Modifiers' button and then set the values in the window that pops up:

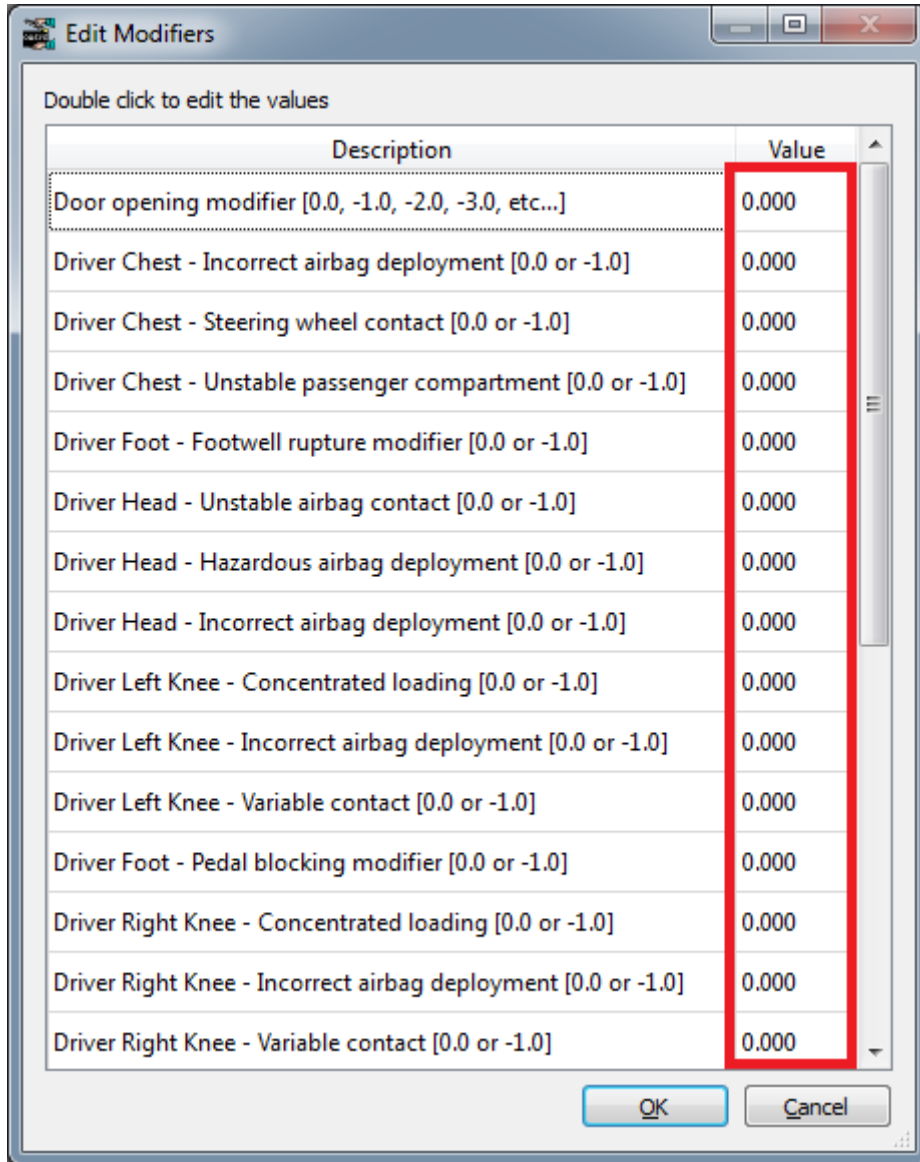

After setting the values and pressing 'OK' the template will recalculate the scores. This allows you to carry out 'what-if' type analyses.

General Ansys LS-DYNA Model template

The General Ansys LS-DYNA Model template is a basic single analysis template that can be run for any Ansys LS-DYNA model.

As with any of the single analysis templates, REPORTER will prompt you to select the keyword file of the job you want to post-process, the directory containing the results, and the directory to which you wish to write images. It will then scan the *.otf (or d3hsp) file in order to provide diagnostic information in a summary table. The information includes the Ansys LS-DYNA version used, the computation time and the termination status.

REPORTER will also use the results files to produce an energy balance plot and to produce images of the model at the first and last plot states. These basic report data



serve as a quick method for checking the successful outcome of an Ansys LS-DYNA simulation.

General Ansys LS-DYNA Vehicle Model template

The General Ansys LS-DYNA Vehicle Model template is the same as the General Ansys LS-DYNA Model template, with the addition of an intrusion plot output. The intrusion plot shows the deformation of selected parts (e.g. dashboard or driver door components) relative to fixed reference nodes (e.g. three nodes on the undamaged body structure on the far side of the vehicle).

If you have not previously saved the information required to set up the intrusion plot, REPORTER will inform you that it will start PRIMER so you can select the required information interactively. You will need to define:

- **Vehicle Impact**

Choose either Front Impact or Side Impact. This controls the camera angle for the intrusion plot. Front Impact assumes that the impact is in the global +X or -X direction whereas Side Impact assumes global +Y or -Y direction.

- **Intrusion Parts**

Select the parts that will be shown in the intrusion plot. Remaining parts will be blanked.

- **Ref Nodes**

Displacement magnitude will be plotted relative to a triad of three nodes using D3PLOT's REFERENCE_NODE tool (refer to 6.3.5 in the D3PLOT manual). Select three nodes on a relatively undeformed part of the structure on the far side of the vehicle from the impact, with nodes N1 and N2 aligned with the impact direction.

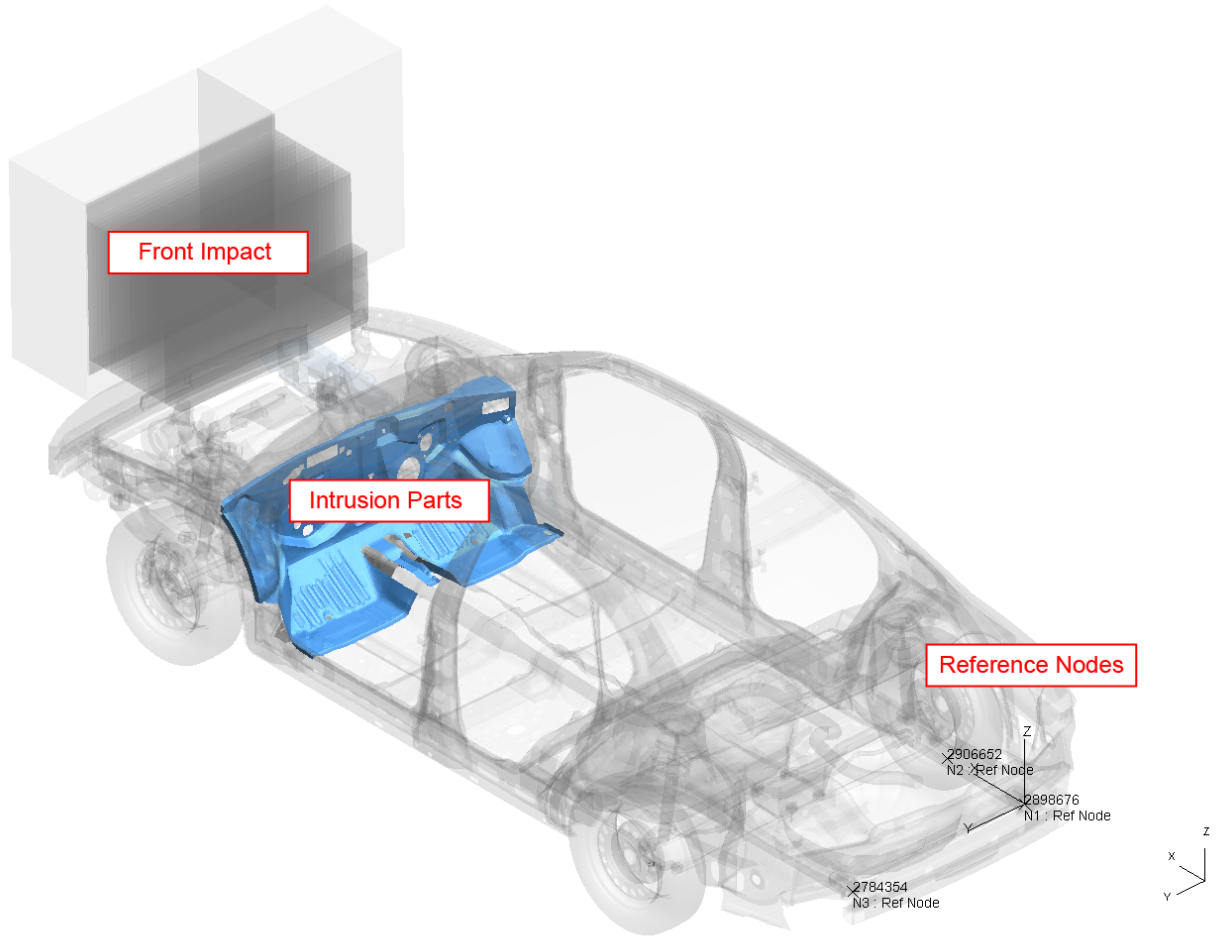



21.2.7.4. Multiple Analysis Templates

Multiple analysis templates

For the pedestrian impact protocols multiple analyses are run with impacts on different parts of the vehicle. The scores for each impact are combined to calculate an overall score for the test.

There are two multiple analysis type templates:

- Pedestrian headform impacts
- Pedestrian legform impacts

Generally they follow the same process, but they are different enough that we'll go through an example of how to use them both.

The section will describe how to run them interactively using the menus in REPORTER, but it is also possible to run them in [batch](#) mode.

Pedestrian headform

Select the template

Use the **File Open Library Template** menu and select a template from the **Automotive** tab (see [Reading an existing template or report](#) for more details).

Generate the template

After selecting the template REPORTER should prompt you to select the *.lst* file for the **adult** head impacts.

The *.lst* file is a simple text file that lists the file locations of each model keyword file. If you use [PRIMERs model build process](#) to create the models it is created automatically. If not, you can create it manually or as part of your own process for building the models. The names of the models are important as they tell the template the location/zone of the impactor. If you have used the [pedestrian markup script](#) in PRIMER, they will be named correctly.

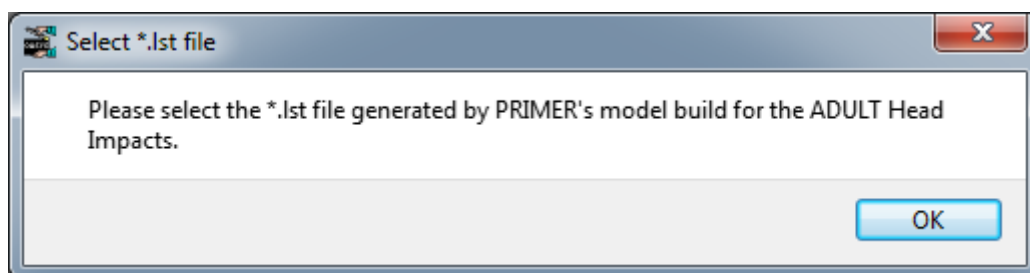



After pressing 'OK' a file selector is mapped for you to select the *.lst* file. If you do not want to process the adult head impacts or you don't have a *.lst* file, press cancel in the file selector.

In order to correctly extract the results needed for the protocol the template needs model information such as Node IDs and the unit system etc. This needs to be supplied to the template from comments written in the *.lst* file and the template will help you to create this information.

The template will scan the *.lst* file to see if it contains the required information. If it does you will be asked if you want to use it:

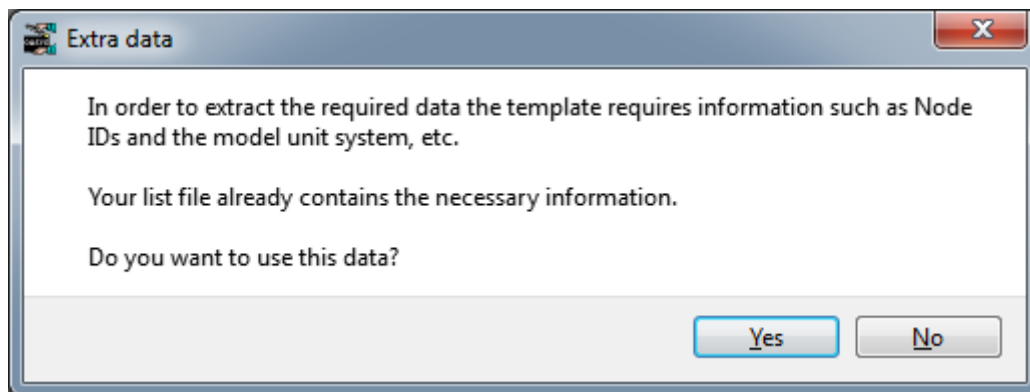

If you press 'No' or the *.lst* file does not contain the required information REPORTER will inform you that it will start PRIMER so you can select the required information interactively:

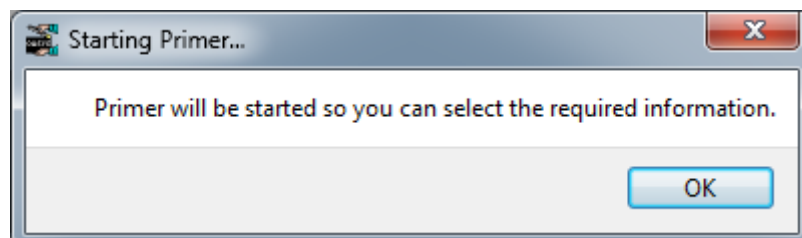

After pressing 'OK' PRIMER will start, the first model in the *.lst* file will be read in and a window will be open for you to interactively select the required information. Select the information in the same way as described in the [single analysis template](#) section.

On returning to REPORTER you should be prompted to select the *.lst* file for the **child** head impacts. This follows the same process as for the adult *.lst* file. If you do not want to process the child head impacts or you don't have a *.lst* file, press cancel in the file selector. So long as you have selected at least one *.lst* file, the template should generate.

Finally you will be asked for a directory where REPORTER should write any images.

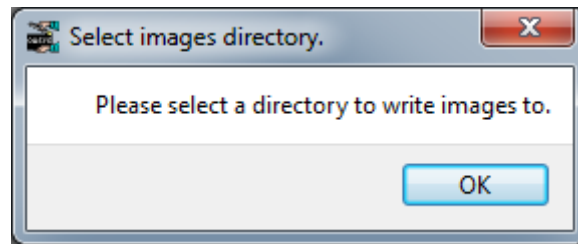

Press OK and select the directory.

REPORTER should now have all the information it needs. T/HIS will load and carry out the post-processingg according to the selected protocol, generating the required graphs. Once this is finished, REPORTER will ask a final question asking you how/if you want to save the report:

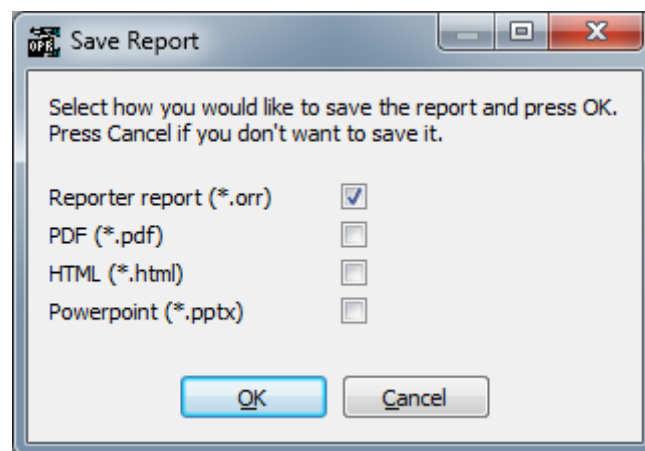

If you don't want to save the report, just press 'Cancel'. If you do, select the format(s) you want to save it in, press 'OK' and select where you want to save it in the file selector that will pop up.

The final report should look something like this, with a front summary page showing the protocol scores in tables and as an image; a pages to set default scores; a page to set test point and blue zone scores; and pages of head acceleration graphs for each impact point:

EuroNCAP Head Impact Grid Method - 2014

Pedestrian Headforms

Set Defaults

PREDICTION		Nr of points	Score	%-age
	Default Green (D)	0	0.000	0.00%
	Green	134	134.000	74.44%
	Yellow	12	9.000	6.67%
	Orange	20	10.000	11.11%
	Brown	7	1.750	3.89%
	Red	7	0.000	3.89%
	Default Red (D)	0	0.000	0.00%
	Blue	0		0.00%
Predicted headform score	(excluding blue points)	180	154.750	100.00%

2/93

This will bring up a window where you can set the default values either to GREEN, RED or leave blank.

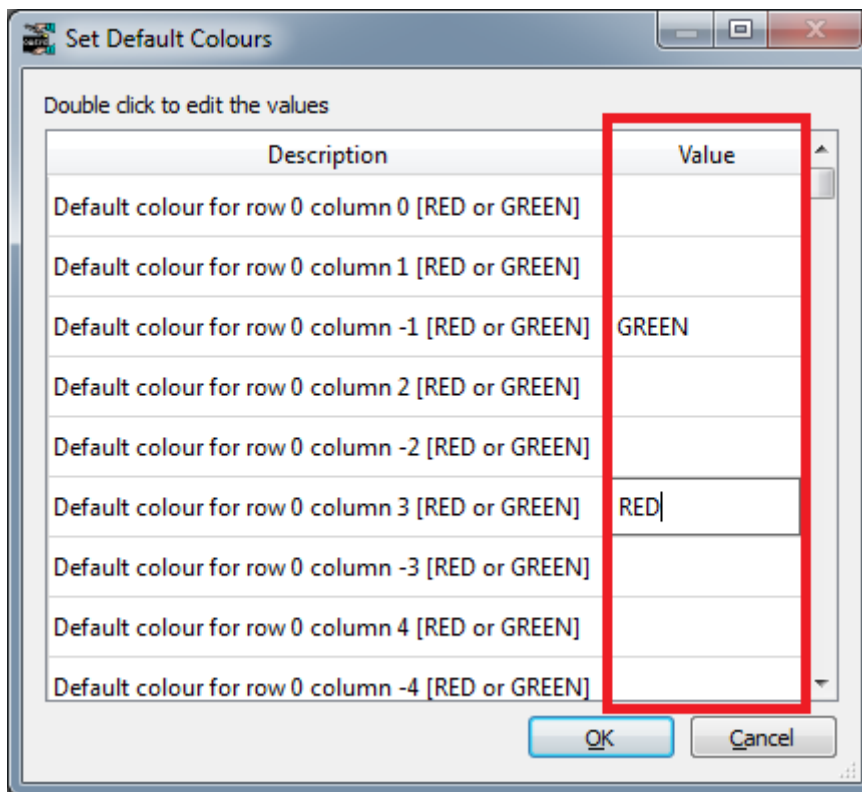

Once you have set the values and pressed 'OK' the scores will update automatically.

Alternatively, you can get the template to automatically default points to GREEN when the LST file is read in. This requires a special comment '**\$DG:**' before each file location. e.g.

```
$DG:C:\Model\A_1_1\a_1_1.key
C:\Model\A_1_2\a_1_2.key
$DG:C:\Model\A_1_3\a_1_3.key
```

will default the score for the 1st and 3rd model to GREEN and will not attempt to read any results for them.

This can be done automatically if you use the [pedestrian markup script](#) in PRIMER. You can select an area where you want the points to default to green and PRIMER will add the 'DG:' comments to the correct lines in the LST file.

Test points

The results from the analyses are scaled using a correction factor, which is calculated based on results from a number of real world verification tests. The correction factor is calculated by dividing the actual tested total score of the verification points by the predicted total points of these verification points.

The correction factor is then applied to all points except for [defaulted](#) and [blue points](#).

To specify the test points press the 'Set Test Points' button on the third page:

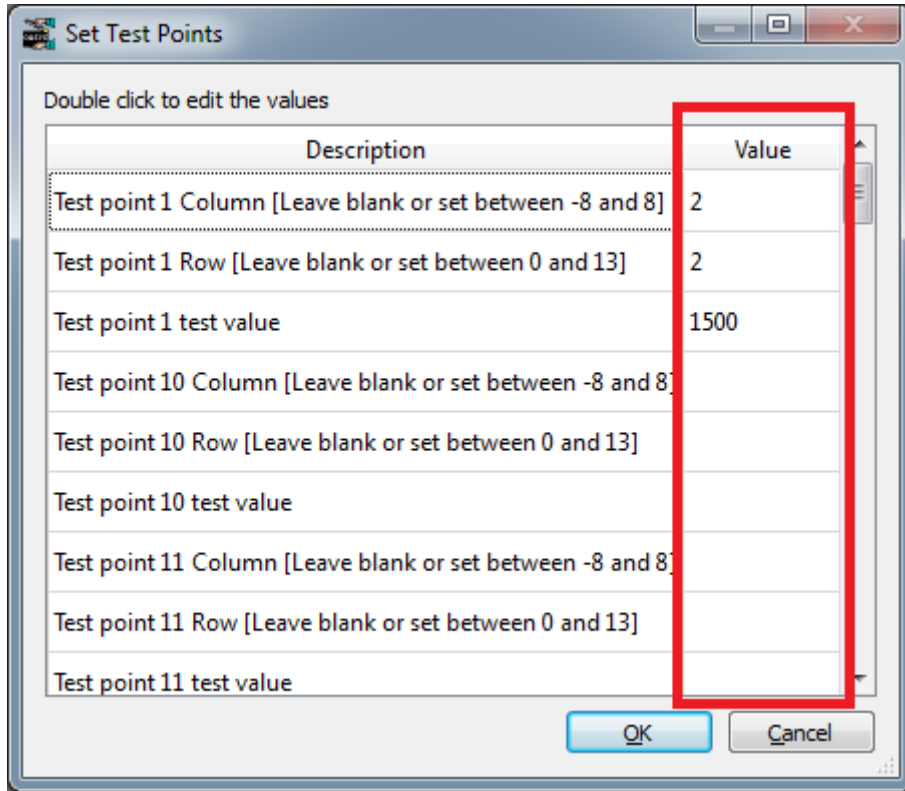

Once you have set the values and pressed 'OK' the scores will update automatically.

If no test points are specified a correction factor of 1.0 is used.

Blue zones

Some impact point locations may give unpredictable results when analysed and in these cases test data can be used instead. These are specified as blue points, either singly or grouped together in adjacent pairs to form a blue zone. Up to 8 blue zones can be specified. The test results of the blue points are applied to each point in the zone.

To specify blue points press the 'Set Blue Zone' button on the third page:

EuroNCAP Head Impact Grid Method - 2014

Correction Factor = Predicted Score / Test Score

VERIFICATION

Testpoint	Prediction	Value	Score	Testpoint	Prediction	Value	Score
Total					0.000		0.000
Correction Factor						1.000	

Total Blue Points = Sum of score for each blue zone

BLUE POINTS

Zone	GRID-point	Value	Score	Zone	GRID-point	Value	Score
1			0.000	5			0.000
2			0.000	6			0.000
3			0.000	7			0.000
4			0.000	8			0.000
Total Blue Points						0.000	

This will bring up a window where you can enter the test point row, column and value (HIC) for up to 8 blue zones:

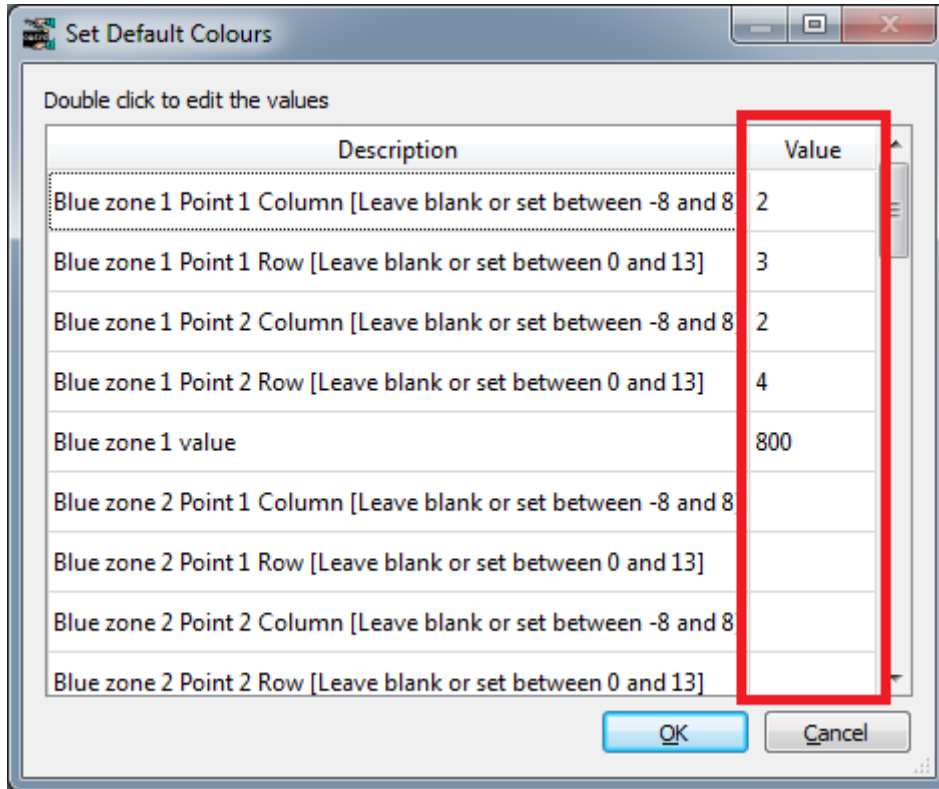

Once you have set the values and pressed 'OK' the scores will update automatically.

Pedestrian legform

Select the template

Use the [File Open Library Template](#) menu and select a template from the **Automotive** tab (see [Reading an existing template or report](#) for more details).

Generate the template

After selecting the template REPORTER should prompt you to select the `.st` file for the **lower** leg impacts.

The `.st` file is a simple text file that lists the file locations of each model keyword file. If you use [PRIMERs model build process](#) to create the models it is created automatically. If not, you can create it manually or as part of your own process for building the models. The names of the models are important as they tell the template the location/zone of the impactor. If you have used the [pedestrian markup script](#) in PRIMER, they will be named correctly.

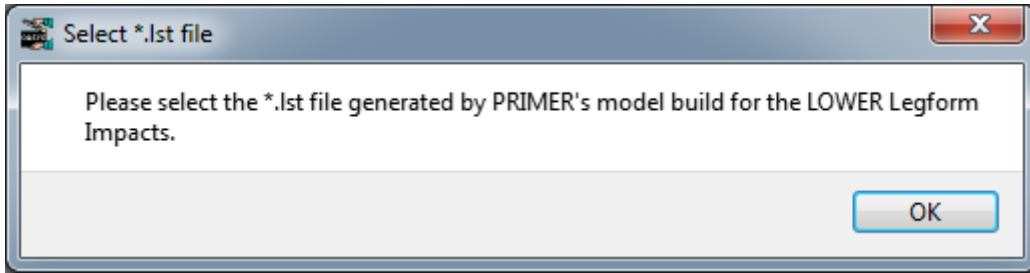

After pressing 'OK' a file selector is mapped for you to select the *.lst* file. If you do not want to process the lower leg impacts or you don't have a *.lst* file, press cancel in the file selector.

In order to correctly extract the results needed for the protocol the template needs model information such as Node IDs and the unit system etc. This needs to be supplied to the template from comments written in the *.lst* file and the template will help you to create this information.

The template will scan the *.lst* file to see if it contains the required information. If it does you will be asked if you want to use it:

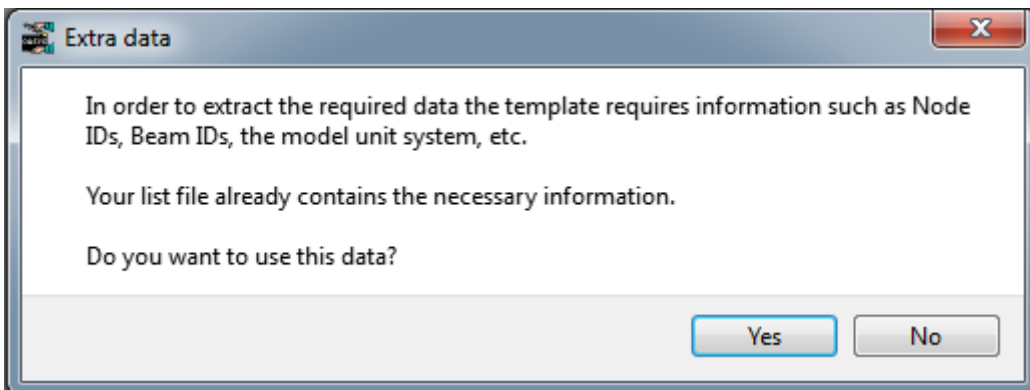

If you press 'No' or the *.lst* file does not contain the required information REPORTER will inform you that it will start PRIMER so you can select the required information interactively:

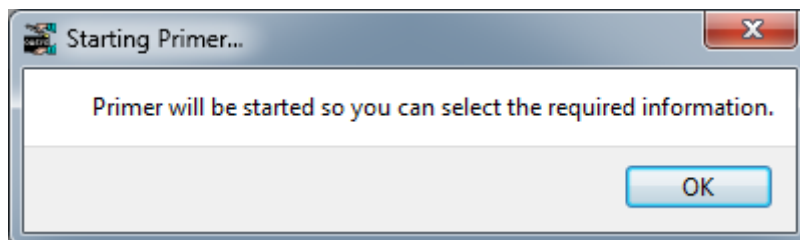

After pressing 'OK' PRIMER will start, the first model in the *.lst* file will be read in and a window will be open for you to interactively select the required information. Select the information in the same way as described in the [single analysis template](#) section.

On returning to REPORTER you should be prompted to select the LST file for the **upper** leg impacts. This follows the same process as for the lower *.lst* file. If you do not want to



process the upper leg impacts or you don't have a *.lst* file, press cancel in the file selector. So long as you have selected at least one *.lst* file, the template should generate.

Finally you will be asked for a directory where REPORTER should write any images.

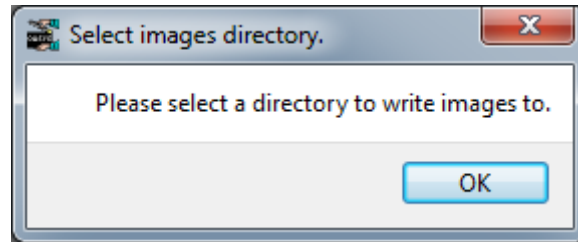

Press OK and select the directory.

REPORTER should now have all the information it needs. T/HIS will load and carry out the post-processingg according to the selected protocol, generating the required graphs. Once this is finished, REPORTER will ask a final question asking you how/if you want to save the report:

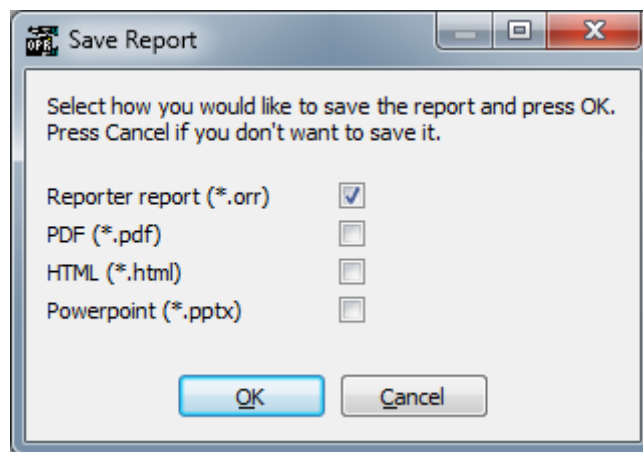

If you don't want to save the report, just press 'Cancel'. If you do, select the format(s) you want to save it in, press 'OK' and select where you want to save it in the file selector that will pop up.

The final report should look something like this, with a front summary page showing the protocol scores in tables and as an image and pages of tabulated results and graphs for each impact point:



21.2.7.5. Running the Templates in Batch Mode

Running the templates in batch mode

As well as running the templates interactively they can also be run in batch mode, in which case the user is not prompted with questions, but must supply the information through a command line argument.

To run a template in batch, type in the following at a command prompt:

```
reporter 23.exe -batch -file= template_name -varTEMPLATE_ARGS= args_filename
```

[Add the -pdf, -html, -pptx [command line arguments](#) to write the report out in the format you want].

Where:

<i>template_name</i>	The full path and filename of the template you want to use, e.g. C:\oasys 23\reporter_library\templates\EuroNCAP_Front_ODB_Impact_2017.ort x Note that you should enclose it in "s if the path contains any spaces.
<i>args_filename</i>	The full path and filename of the arguments file, e.g. C:\my_directory\arguments_file.txt Note that you should enclose it in "s if the path contains any spaces.

The *args_filename* is a CSV file containing the arguments to pass to the template in comma separated 'arg_name','arg_value' pairs. For the EuroNCAP Front ODB Impact template the file can contain the following:

```
KEYWORD_FILE,<keyword_filename>  
CSV_FILE,<csv_filename> [OPTIONAL]  
RESULTS_DIR,<results_directory> [OPTIONAL]  
IMAGES_DIR,<images_directory> [OPTIONAL]
```

As with the interactive case where the template behaves differently depending on the users response to the questions, the interactive case will work differently depending on what arguments are supplied, e.g.:

KEYWORD_FILE specified	Post *END data in keyword file	CSV_FILE specified	Outcome
-------------------------------	---------------------------------------	---------------------------	----------------



No	-	-	Template will not run
Yes	No	No	Template will not run
Yes	Yes	No	Template will run using the post *END data
Yes	Yes	Yes	Template will run using the CSV file data
Yes	No	Yes	Template will run using the CSV file data

If RESULTS_DIR or IMAGES_DIR are not specified then they are set to the keyword file directory.

A description for each argument is given in the table below:

Argument	Description
CSV_FILE	Filename of the CSV file containing the extra data (entity IDs, etc). For single analysis templates, if CSV_FILE is not specified then the data needs to be specified in the keyword file as post-*END data.
JSON_FILE	Used instead of CSV_FILE by ICFD Assessment template. Note that ICFD Assessment template does not support post-*END data.
IMAGES_DIR	Model keyword filename.
RESULTS_DIR	Directory to look for results. If this is not specified the template will look for results in the same directory as the keyword file.
SIDE_EXCURSION_FILE	Used by the Euro NCAP Far Side Impact 2022 template to provide the CSV file containing the side excursion information containing (generated by Euro NCAP Side MDB or Side Pole 2020 templates).
ADULT_LST_FILE	Adult .lst filename. For head impact templates, at least one of ADULT_LST_FILE, CHILD_LST_FILE_FILE or CYCLIST_LST_FILE needs to be specified.



CHILD_LST_FILE	Child <i>.lst</i> filename. For head impact templates, at least one of ADULT_LST_FILE, CHILD_LST_FILE_FILE or CYCLIST_LST_FILE needs to be specified.
CYCLIST_LST_FILE	Cyclist <i>.lst</i> filename. For head impact templates, at least one of ADULT_LST_FILE, CHILD_LST_FILE_FILE or CYCLIST_LST_FILE needs to be specified.
LOWER_LEG_LST_FILE	Lower leg <i>.lst</i> filename. For leg impact templates, at least one of LOWER_LEG_LST_FILE or UPPER_LEG_LST_FILE needs to be specified.
UPPER_LEG_LST_FILE	Upper leg <i>.lst</i> filename. For leg impact templates, at least one of LOWER_LEG_LST_FILE or UPPER_LEG_LST_FILE needs to be specified.

The list of arguments required for each template is given in the table below. Note that for the single analysis templates, CSV_FILE is required unless the input data is stored in your keyword file as post-*END data.

Template	Required arguments	Optional arguments
C-NCAP Front ODB Impact 2018	KEYWORD_FILE	CSV_FILE, IMAGES_DIR, RESULTS_DIR
C-NCAP Head Impact 2021	(At least one of ADULT_LST_FILE, CHILD_LST_FILE or CYCLIST_LST_FILE)	ADULT_LST_FILE, CHILD_LST_FILE, CYCLIST_LST_FILE, IMAGES_DIR
C-NCAP Leg Impact 2021	(At least one of LOWER_LEG_LST_FILE or UPPER_LEG_LST_FILE)	LOWER_LEG_LST_FILE, UPPER_LEG_LST_FILE, IMAGES_DIR
C-NCAP MPDB 2022-23 Compatibility Assessment	DEFAULT_DIR, DEFAULT_JOB, CSV_FILE	IMAGES_DIR
C-NCAP MPDB 2022 Occupant Assessment	KEYWORD_FILE	CSV_FILE, IMAGES_DIR, RESULTS_DIR
Euro NCAP Far Side Impact 2022	KEYWORD_FILE, SIDE_EXCURSION_FILE	CSV_FILE, IMAGES_DIR, RESULTS_DIR
Euro NCAP Front FFB Impact 2017	KEYWORD_FILE	CSV_FILE, IMAGES_DIR, RESULTS_DIR



Euro NCAP Front ODB Impact 2017	KEYWORD_FILE	CSV_FILE, IMAGES_DIR, RESULTS_DIR
Euro NCAP Head Impact 2023	(At least one of ADULT_LST_FILE and CHILD_LST_FILE)	ADULT_LST_FILE, CHILD_LST_FILE, CYCLIST_LST_FILE, IMAGES_DIR
Euro NCAP Leg Impact 2023	(At least one of LOWER_LEG_LST_FILE or UPPER_LEG_LST_FILE)	LOWER_LEG_LST_FILE, UPPER_LEG_LST_FILE, IMAGES_DIR
Euro NCAP MPDB 2020-23 Compatibility Assessment	DEFAULT_DIR, DEFAULT_JOB, CSV_FILE	IMAGES_DIR
Euro NCAP MPDB 2020 Occupant Assessment	KEYWORD_FILE	CSV_FILE, IMAGES_DIR, RESULTS_DIR
Euro NCAP Side MDB Impact 2020	KEYWORD_FILE	CSV_FILE, IMAGES_DIR, RESULTS_DIR
Euro NCAP Side Pole Impact 2020	KEYWORD_FILE	CSV_FILE, IMAGES_DIR, RESULTS_DIR
General LS-DYNA Vehicle Model	KEYWORD_FILE	CSV_FILE, IMAGES_DIR, RESULTS_DIR
GTR Head Impact 2020	(At least one of ADULT_LST_FILE and CHILD_LST_FILE)	ADULT_LST_FILE, CHILD_LST_FILE, IMAGES_DIR
GTR Leg Impact 2019	(At least one of LOWER_LEG_LST_FILE or UPPER_LEG_LST_FILE)	LOWER_LEG_LST_FILE, UPPER_LEG_LST_FILE, IMAGES_DIR
IIHS Front ODB Impact 2021	KEYWORD_FILE	CSV_FILE, IMAGES_DIR, RESULTS_DIR
IIHS Front ODB Impact 2021 - Structure Only	KEYWORD_FILE	CSV_FILE, IMAGES_DIR, RESULTS_DIR
IIHS Front SOB Impact 2021	KEYWORD_FILE	CSV_FILE, IMAGES_DIR, RESULTS_DIR
IIHS Front SOB Impact 2021 - Structure Only	KEYWORD_FILE	CSV_FILE, IMAGES_DIR, RESULTS_DIR
IIHS Side MDB Impact 2021	KEYWORD_FILE	CSV_FILE, IMAGES_DIR, RESULTS_DIR



IIHS Side MDB Impact 2021 – Structure Only	KEYWORD_FILE	CSV_FILE, IMAGES_DIR, RESULTS_DIR
JNCAP Leg Head Impact 2018	(At least one of LOWER_LEG_LST_FILE or UPPER_LEG_LST_FILE)	LOWER_LEG_LST_FILE, UPPER_LEG_LST_FILE, IMAGES_DIR
KNCAP Leg Head Impact 2019	(At least one of LOWER_LEG_LST_FILE or UPPER_LEG_LST_FILE)	LOWER_LEG_LST_FILE, UPPER_LEG_LST_FILE, IMAGES_DIR
USNCAP Front FFB Impact 2015	KEYWORD_FILE	CSV_FILE, IMAGES_DIR, RESULTS_DIR
USNCAP Side MDB Impact 2015	KEYWORD_FILE	CSV_FILE, IMAGES_DIR, RESULTS_DIR
USNCAP Side Pole Impact 2015	KEYWORD_FILE	CSV_FILE, IMAGES_DIR, RESULTS_DIR



21.3. C. FAQ

21.3.1. FAQ

FAQ

This section gives answers to some common questions which have been asked about REPORTER . Over time this FAQ will be extended. If the answer to your question is not here then contact Oasys Ltd Support.

Can I run REPORTER from the command line?

Yes you can. See [appendix A](#) for a list of command line options.

Do I need a license to run REPORTER ?

To run REPORTER you need a valid license for REPORTER or alternatively a valid license for D3PLOT , T/HIS or PRIMER. To get maximum benefit from REPORTER , D3PLOT and T/HIS are required.

How do I get REPORTER to run automatically after my Ansys LS-DYNA job finishes?

Use [Oasys SHELL](#) to submit your job which has options to allow you to run REPORTER automatically.

How do I run REPORTER in batch mode?

REPORTER does not have a batch mode which means that it requires a display to be able to draw things on. In reality this is not too much of a problem as D3PLOT will also need a display. You can give a DISPLAY that REPORTER can display back to. This can be a computer which is left logged in or a virtual display using xvfb. Additionally to stop REPORTER from pausing to ask for confirmations you should use the `-batch` command line argument.

None of my scripts/programs work on windows

1. Do you have perl, python, Tcl (or whatever your script is written in) installed on your machine?
2. Do you have the correct file extensions and associations for this type of file. e.g. for perl the script should be 'script.pl' and this should be associated with the perl executable on your machine.
3. Do any of the program arguments have spaces in them? If so you may need to quote them. For example:

```
%MYPATH%\scripts\title.pl " C:\my directory\my file with spaces.key "
```

Can I write my own scripts?

Yes. See [Scripting](#) and the JavaScript API reference manual for more details.

Can I add new scripts/images/pages to the library?

Yes. See [Standard library objects](#) for more details.



Text appears to be bigger/smaller on the screen than in a postscript/pdf file.

This can be a problem on Unix machines. Unlike windows machines which use true type fonts, fonts on unix are stored as bitmaps. Only certain sizes are actually available. If you request a size that is not available the one that is displayed could be the wrong size.

To get a list of the fonts (and sizes) on your unix machine use the command `xlsfonts` .

If you are trying to see how much space some text will take up in the presentation view try zooming into the page. This may help.

REPORTER doesn't have xxxx capability. Can you add it?

We will try. Please contact Oasys Ltd Support to discuss it.



21.4. D. Writing External Programs/Scripts

Writing external programs/scripts

Programs or scripts for REPORTER that do some external function can be written in any language. It is up to you if you prefer to use a scripting language such as Perl, Python, Tcl etc or a compiled language such as C or Fortran.

Anything which a program prints to stdout (standard output) will be returned to REPORTER (the one exception to this is returning variables which is described below)

21.4.1. Returning Variables From Programs

Returning variables from programs

To return a variable back to REPORTER output a line that take the form

```
VAR <NAME> VALUE="<value>" DESCRIPTION="<description>"  
or  
VAR <NAME> VALUE="<value>"
```

It will not inserted into the report as text but will be used to create a variable. See [Creating a variable using an external program/script](#) for more details.

21.4.2. Accessing Existing Variables in REPORTER

Accessing existing variables in REPORTER

If you only want to use one or two variables from REPORTER then they can be passed as arguments to your program. However, if you want to access a lot of variables (or print all the variables to a file) this would not be possible.

To overcome this, REPORTER adds an extra argument to every program that it runs. This extra argument is a filename which contains lines of the form:

```
VAR <NAME> VALUE="<value>" DESCRIPTION="<description>"
```

You can read this file and pick up all the variables from REPORTER.



21.4.3. Example perl Program to Read Variables File from REPORTER

Example perl program to read variables file from REPORTER

The following example shows how you could read this file.

Copy Code
Perl

```
# Skeleton REPORTER Perl script showing extraction of variables fed
to program
# The variable file REPORTER generates will be the LAST argument
#
# Variables are stored in a hash '%vars', each entry in the hash
contains
# {value} and {description}.
#
# e.g. If REPORTER has a variable 'FRED' with value '1' and
description
# 'Example variable' you can get at the variable value and
description using:
#
# $vars{FRED}->{value}
# $vars{FRED}->{description}
#
# Arguments
# =====
# 1: Variables file
#
# Miles Thornton 23/5/2002
#
%vars = ();

if ($#ARGV >= 0)
{
    open (VAR, "< $ARGV[$#ARGV]") or die "Error: Cannot open
variable file";

    while ( <VAR> )
    {
        chomp;
        &get_var_from_string($_);
    }
}
else
{
    die "Error: No variable file on the command line
";
}

#####
```

```

# START OF YOUR PROGRAM
#
# e.g. loop over variables and save them to a file

open (SAVE, "> varfile") or die "Error: Cannot open variables
file";

foreach $var (sort keys %vars)
{
    print SAVE "Variable $var value=$vars{$var}->{value} ",
              "desc=$vars{$var}->{description}
";
}

close (SAVE);

# END OF YOUR PROGRAM
#####

exit;

# =====
sub get_var_from_string
# =====
#
# Tries to read a variable from the variable file
#
{
    my $string = shift;

    my ($var, $val, $desc);

    if ($string =~ /VAR\s+(\w+)\s+
                VALUE\s*=\s*['"](.*)['"]\s*
                DESCRIPTION\s*=\s*['"](.*)['"]
                /x)
    {
        $var = $1;
        $val = $2;
        $desc = $3;
    }
    elsif ($string =~ /VAR\s+(\w+)\s+
                DESCRIPTION\s*=\s*['"](.*)['"]\s*
                VALUE\s*=\s*['"](.*)['"]
                /x)
    {
        $var = $1;
        $val = $3;
        $desc = $2;
    }
    elsif ($string =~ /VAR\s+(\w+)\s+
                VALUE\s*=\s*['"](.*)['"]
                /x)
    {
        $var = $1;
        $val = $2;
    }
}

```

```
$desc = undef;

}

if ($var)
{
    $var = uc($var);
    $var =~ s/\s+/_/g;

    if (exists $vars{$var})
    {
        $vars{$var}->{value} = $val;
        $vars{$var}->{description} = $desc;
    }
    else
    {
        my $variable = {};
        $variable->{value} = $val;
        $variable->{description} = $desc;

        $vars{$var} = $variable;
    }
}
}
```



21.4.4. Example Program: Extracting the Smallest Timesteps (Text Output)

Example program: Extracting the smallest timesteps (Text output)

These programs/scripts are designed to extract from the OTF file the 5 elements with the smallest timesteps, and write out the data as text to the standard output. They also output the smallest timestep as a REPORTER variable called `TIMESTEP`. Note that these programs/scripts are only simple examples and as such don't have all the necessary error checking that should be included.

They work by searching the OTF file for the text string "100 smallest timesteps" which appears towards the end of the model initialization section, and then reading in relevant element data from this list. An example of this section of an OTF file is shown below. The one argument for this program/script is the OTF filename (for example tube2.otf).

```
The LS-DYNA time step size should not exceed 0.133E-05
to avoid contact instabilities. If the step size is
bigger then scale the penalty of the offending surface.
  0 t 0.0000E+00 dt 0.00E+00 flush i/o buffers
```

```
100 smallest timesteps
-----
element                timestep
shell      16620        0.66873E-06
shell      16619        0.66873E-06
shell      16612        0.66873E-06
shell      16611        0.66873E-06
shell      16572        0.66873E-06
shell      16571        0.66873E-06
shell      16564        0.66873E-06
shell      16563        0.66873E-06
shell      16520        0.66873E-06
shell      16519        0.66873E-06
shell      16512        0.66873E-06
shell      16511        0.66873E-06
shell      16504        0.66873E-06
shell      16503        0.66873E-06
shell      16472        0.66873E-06
```

Example programs to extract the data are shown in 4 languages:

- [C](#)
- [C shell script](#)
- [Fortran](#)



- [Perl](#)



C program/script

Copy Code

C/C++

```
#include <stdio.h>
#include <stdlib.h>
#include <string.h>
#define MAX_LEN 257

int main(int argc, char *argv[])
{
    char line[MAX_LEN], *ptr;
    int c, i, l, n = 5;
    float t, tmin;
    FILE *fp;
    if (argc < 2)
    {
        printf("No otf filename
");
        exit(0);
    }
    if ( (fp = fopen(argv[1], "r")) == NULL)
    {
        printf("Cannot open otf file %s
", argv[1]);
        exit(0);
    }
    while (fgets(line, MAX_LEN, fp))
    {
        if (strstr(line, "smallest timesteps"))
        {
            sscanf(line, "%d", &n);
            if (n > 5) n = 5;
            tmin = 1.0e+20;
            fgets(line, MAX_LEN, fp);
            fgets(line, MAX_LEN, fp);
            for (i=0; i<n; i++)
            {
                fgets(line, MAX_LEN, fp);
                printf ("%s", line);
                /* Remove any trailing characters */
                l = strlen(line) - 1;
                while ( (c = line[l]) == ' ' || c=='
' || c=='\t')
                    l--;
                line[l+1] = '\0';
                /* Find start of number */
                l = strlen(line) - 1;
                while ( (c = line[l]) != ' ')
                    l--;
                ptr = &line[l];
            }
        }
    }
}
```



```
        sscanf(ptr, "%e", &t);
        if (t < tmin)
            tmin = t;
    }
    printf ("VAR TIMESTEP VALUE=\"%e\"
", tmin);
    exit(0);
}
}
fclose(fp);
}
```



C Shell program/script

Copy Code

Bash (Unix Shell)

```
#!/bin/csh -f
#
# Script to extract the 5 smallest timesteps from otf file
#
# Arguments: 1: otf filename

# Test to see if there is an argument
if ($#argv < 1) then
    echo "No otf filename";
    exit;
endif
# test to see if the otf file exists
if ( !(-e $argv[1]) ) then
    echo "otf file $argv[1] does not exist";
    exit;
endif
# Use awk to extract the timesteps
awk '/smallest timesteps/ {                # search for smallest
timestep \n                                n = $1;                # save how
many found \n                              getline;              # skip a
line \n                                    getline;                # skip a line \n
if (n > 5) n = 5;                          # limit to 5 timesteps \n
t = 1.0e+20;                                # initialise smallest timestep \n
for (i=0; i<n; i++)                          # loop over lines \n          {
# \n                                        getline;                # read the line \n
print $0;                                    # print it \n                    if ($NF <
t) t = $NF; # save timestep if smaller \n                                }
# than current smallest \n                                }
# \n END {                                    # \n
printf ("VAR TIMESTEP VALUE=\"%e\"
", t); # Print smallest timestep \n
# \n ' $argv[1]
```



21.4.4.3. Fortran Program/Script

Fortran program/script

```
c
    character*80 fname,line
    integer elemno(5)
    real timestep(5)
    n=iargc(1)

c
c Read in model name argument
c
    call getarg(1, fname)
c
c Open model OTF file
c
    open (unit=25, file=fname, status='old')
c
c Scan file for line with the text string
c " 100 smallest timesteps"
c
10  continue
    read (25,'(a)',end=900) line
    if (line(1:23).eq.' 100 smallest timesteps') then
        goto 20
    else
        goto 10
    endif

c
c Read in but ignore next 2 lines of data
c
20  continue
    read(25,*)
    read(25,*)

c
c Read in the element no. and timestep data
c from the next five lines
c
101 format(i10)
102 format(e23.0)
c
    do 30 i=1,5
        read (25,'(a)') line
        read (line(7:16),101) elemno(i)
        read (line(20:42),102) timestep(i)
30  continue

c
c Write out the data as a text output
c
201 format (2x,i9,5x,e11.5)
c
    write (*,*) ' Element No.      Timestep  '
    do 40 i=1,5
        write (*,201) elemno(i),timestep(i)
40  continue

c
c Also write out the smallest timestep as
```



```
c REPORTER variable
c
 301 format ('VAR TIMESTEP VALUE="',e11.5, '"')
    write(*,301) timestep(1)
    goto 999
c
 900 write(*,*) 'End of file reached'
c
 999 continue
    stop
    end
c
```



Perl program/script

Copy Code

Perl

```
# Perl Script to extract the 5 smallest timesteps from otf file
#
# Arguments: 1: otf filename

use strict;

# Test to see if there is an argument
if ($#ARGV < 0)
{
    print "No otf filename
";
    exit;
}
# test to see if the otf file exists
if ( !(-e $ARGV[0]) )
{
    print "otf file $ARGV[0] does not exist
";
    exit;
}
open (OTF, "< $ARGV[0]");
my $n;
my $t = 1.0e+20;
while ( <OTF>)
{
    if (/ (\d+) smallest timesteps/)
    {
        $n = $1;
        if ($n > 5) { $n = 5; }
        <OTF>;
        <OTF>;
        for (my $i=0; $i<$n; $i++)
        {
            $_ = <OTF>;
            print $_;
            my @f = split;
            if ($f[$#f] < $t) { $t = $f[$#f]; }
        }
        print "VAR TIMESTEP VALUE=\"$t\"
";
        exit;
    }
}
close (OTF);
```



21.5. E. Unicode Support

21.5.1. Unicode Support

Unicode support

REPORTER has basic unicode (i.e. non-latin characters) support. This means that if you have the appropriate language kit and fonts installed on your computer you can input and use European accented, Japanese, Korean and Chinese characters. On Windows you can input unicode characters using the normal IME (global Input Method Editor).

The XML format that REPORTER uses to save files supports unicode.

As Japanese, Korean and Chinese have many common ideographs, but these may have different appearances depending on the font there is a preference in REPORTER which allows you to set the default language you want to use, `reporter*cjk_default` which can be either `Chinese` , `Japanese` or `Korean` .

Note that although REPORTER has unicode support, currently D3PLOT , T/HIS and Ansys LS-DYNA do not so you should not use unicode characters in filenames.

21.5.2. Output Formats that Support Unicode

Output formats that support unicode

Currently only text objects and table headers can be output with unicode characters.

HTML

Unicode is fully supported in the HTML written by REPORTER . To view the HTML a user needs the appropriate fonts installed.

PowerPoint

Unicode is fully supported in the PowerPoint files written by REPORTER (as long as the appropriate language pack(s) are installed).

PDF

The PDF files created by REPORTER do not embed the fonts used in the document. However, newer versions of the acrobat reader will automatically detect that the document uses a Chinese, Japanese or Korean font and prompt the user to download the necessary fonts.

There are two preferences which affect what fonts are used in pdf files: Firstly for Japanese the preference `reporter*japanese_font` indicates what font



should be used for Japanese characters. It can be 'Kozuka Mincho Pro ' (a serif font) or 'Kozuka Gothic Pro ' (a sans serif font). The default is 'Kozuka Gothic Pro '. For Chinese the preference `reporter*chinese_characters` indicates if traditional or simplified characters should be used. It can be `Traditional` or `Simplified` . the default is `Traditional` .



22. Installation Organisation

Installation organisation

Oasys LS-DYNA Environment 23.0 installation can be customised to try and avoid a number of issues that often occur in large organisations with many users.

- Large organisations generally imply large networks, and it is often the case that the performance of these networks can be intermittent or poor, therefore it is common practice to perform an installation of the software on the local disk of each machine, rather than having a single installation on a remote disk.

This avoids the pauses and glitches that can occur when running executable files over a network, but it also means that all the configuration files in, or depending upon, the top level "Admin" directory have to be copied to all machines and, more to the point, any changes or additions to such files also have to be copied to all machines.

- In larger organisations the "one person per computer" philosophy may not apply, with the consequence that users will tend to have a floating home area on a network drive and may not use the same machine every day.

This is not usually a problem on Linux where the "home" directory is tied to the login name not the machine. However on Windows platforms it means that %USERPROFILE%, which is typically on the local C drive of a machine, is not a good place to consider as "home" since it will be tied to a given computer, therefore a user who saves a file in their home directory on machine A may not be able to access it from machine B.

- In a similar vein placing large temporary files on the /tmp partition (Linux) or the C: drive (Windows) may result in local disks becoming too full, or quotas exceeded.

This section gives only a brief summary of the installation organisation, and you should refer to the separate Installation Guide if you want to find out more about the details of installation, licensing, and other related issues.

22.1. Oasys Suite 23.0 Installation Structure

Oasys Suite 23.0 Installation structure

In Oasys Suite 23.0 the option is provided to separate a top-level 'administration' directory from the 'installation' one where the executables are located.

For large installations on many machines this allows central configuration and



administration files to exist in one place only, but executables to be installed locally on users' machines to give better performance. Oasys Suite 23.0 also allows the following items to be configured

- The location for user manuals and other documentation.
- The definition of a user's home directory.
- The definition of the temporary directory for scratch files.

In addition parsing of the 'oa_pref' (preferences) file will now handle environment variables, so that a generic preference can be configured to give a user-specific result, and preferences may be 'locked' so that those set at the administration level cannot be changed by users.

These changes are entirely optional, and users performing a simple installation on a single machine do not need to make any changes to their existing installation practice.

Directory	Status	Directory Content and purpose	oa_pref file option
OA_ADMIN_XX	<i>Optional</i>	Top level configuration files. (xx =23 for Oasys Suite 23.0, thus OA_ADMIN_23) Admin level oa_pref file Other configuration files Timeout configuration file	
OA_ADMIN	<i>Optional</i>	Same as OA_ADMIN_23 , provided for backwards compatibility with earlier releases. It is recommended that plain OA_ADMIN , without the _xx version suffix, is not used since otherwise there is no easy way of distinguishing between parallel installations of different releases of Oasys LS-DYNA Environment in an installation. <i>If OA_ADMIN_23 is not defined then this non-release specific version is checked.</i>	
OA_INSTALL_XX	<i>Optional</i>	(xx =23 for release 23.0, thus OA_ADMIN_23) All executables Installation level oa_pref file	oasys*install_dir: <pathname>



OA_INSTALL	<i>Optional</i>	<p>Same as OA_INSTALL_23.</p> <p>If no "OA_ADMIN_xx" directory is used and all software is simply placed in this "install" directory, which would be typical of a single-user installation, then it is recommended that the _xx version suffix is used in order to keep parallel installations of different releases of the Oasts Ltd software separate on the machine.</p> <p><i>If OA_INSTALL_23 is not defined then this non-release specific version is checked</i></p>	oasys*install_dir: <pathname>
OA_MANUALS	<i>Optional</i>	<p>Specific directory for user manuals. If not defined then will search in:</p> <p>OA_ADMIN_xx/manuals (xx = major version number) OA_INSTALL/manuals</p>	oasys*manuals_dir: <pathname>
OA_HOME	<i>Optional</i>	<p>Specific "home" directory for user when using Oasys LS-DYNA Environment. If not defined will use:</p> <p>\$HOME (Linux) %USERPROFILE% (Windows)</p>	oasys*home_dir: <pathname>
OA_TEMP	<i>Optional</i>	<p>Specific "temporary" directory for user when using Oasys LS-DYNA Environment. If not defined will use:</p> <p>P_tmpdir (Linux, typically /tmp) %TEMP% (Windows, typically C:\temp)</p>	oasys*temp_dir: <pathname>

It will be clear from the table above that no Environment variables have to be set, and that all defaults will revert to pre-version 9.4 behaviour. In other words users wishing to keep the status quo will find behaviour and layout unchanged if they do nothing.

OA_INSTALL_XX

Previously the software used the **OA_INSTALL** (renamed from **OASYS**) environment variable to locate the directory the software was installed in.

- On Windows this is no longer required as the software can work out its own installation directory. As this environment variable is no longer required it is recommended that it is removed from machines it is currently set on as in some



cases where more than one version has been installed in different directories it can cause problems.

- On LINUX systems the "oasys_23" script that starts the SHELL automatically sets this Environment Variable and passes it to any application started from the SHELL. If you run applications directly from the command line and bypass the SHELL then you should set **OA_INSTALL_XX** so that the software can locate manuals and other required files.

OA_ADMIN_XX

Users wishing to separate configuration and installation directories will be able to do so by making use of the new top level **OA_ADMIN_XX** directory.



22.1.1. Installation Examples

Installation Examples

The following diagrams illustrate how the installation might be organised in various different scenarios..

a) Single user installation on one machine

There is no need to worry about separating administration and installation directories, and the default installation of all files in and below the single installation directory will suffice.

It is suggested that the `_xx` version suffix of `OA_INSTALL_xx` is used in order to keep parallel installations of different releases of the Oassys Ltd software separate on the machine.



b) A few machines on a small network, each user has their own machine

The top level administration directory can be installed on a network server, possibly also locating the manuals centrally.

Each user's machine has its own 'installation' directory to give good performance, but there is no need to manage home or temporary directories centrally since each user 'owns' their machine.

If network performance is good an alternative would be to install executables on the central server, meaning that local `OA_INSTALL` directories are not required.

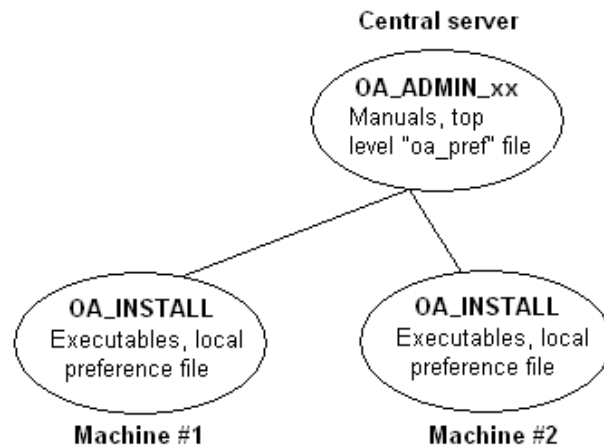

c) Large corporate network



There is no need to worry about separating administration and installation directories, and the default installation of all files in and below the single installation directory will suffice.

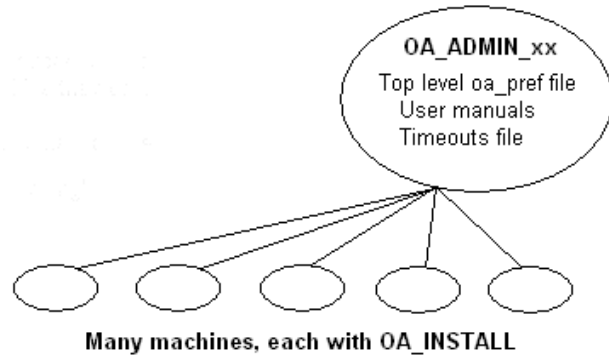



22.1.2. Dynamic Configuration Using the Top Level oa_pref File

Dynamic configuration using the top level oa_pref file.

A further improvement is that all environment variables below `OA_ADMIN_xx` may either be set explicitly, or dynamically using the options in the `oa_pref` file at the top `OA_ADMIN_xx` level. This permits parallel installations of different versions of the software to co-exist, with only the top level administration directory names being distinct. For example:

Oasys Suite 23.0	Oasys Suite 23.1
Top level directory <code>OA_ADMIN_23</code>	Top level directory <code>OA_ADMIN_231</code>
<p>oa_pref file in <code>OA_ADMIN_23</code> contains:</p> <p><code>oasys*install_dir: <pathname for 23.0 installation></code> <code>oasys*manuals_dir: <pathname for 23.0 manuals></code></p> <p><code>oasys*home_dir: <pathname for home directory></code> <code>oasys*temp_dir: <pathname for temporary files></code></p>	<p>oa_pref file in <code>OA_ADMIN_231</code> contains:</p> <p><code>oasys*install_dir: <pathname for 23.1 installation></code> <code>oasys*manuals_dir: <pathname for 23.1 manuals></code></p> <p>} would almost certainly be unchanged between major } versions, although they could be different if desired</p>
Pathnames in the <code>oa_pref</code> file may contain environment variables which will be resolved before being applied.	



22.1.3. The Hierarchy of oa_pref File Reading

The hierarchy of oa_pref file reading

It will be clear from the above that in a large installation the "oa_pref" files have a significant role. Each piece of software reads them in the following order:

OA_ADMIN_XX	Top level configuration
OA_INSTALL_XX	Installation level
OA_HOME	User's personal "home" file
Current working directory	File specific to the current directory (rarely used)

The rules for reading these files are:

- If a given directory does not exist, or no file is found in that directory, then no action is taken. This is not an error.
- A more recently read definition supersedes one read earlier, therefore "local" definitions can supersede "global" ones (unless it was locked).
- If two or more of the directories in the table above are the same then that file is only read once from the first instance.



22.1.4. Locking Preference Options

Locking Preference Options

From version 9.4 onwards, preference options can be locked. If a preference option is locked in a file then that preference option will be ignored in any of the subsequent preference files that are read.

Therefore by locking a preference in a top-level file in the hierarchy above, eg in `OA_ADMIN_xx`, and then protecting that file to be read-only, an administrator can set preferences that cannot be altered by users since any definitions of that preference in their private `oa_pref` files will be ignored.

Preferences are locked by using a hash (#) rather than an asterisk (*) between the code name and the preference string. For example:

<code>*maximise: true</code>	Normal case using "*", means an unlocked preference
<code>#maximise: true</code>	Locked case using "#"

These changes may be made either by editing the file manually, or by using the preferences editor.



23. Licences Used in Software

Licences used in software

Oasys LS-DYNA Environment uses several third party libraries and executables. The licences for them are given below



23.1. Open source

23.1.1. Apple Public Source

Apple Public Source

Copyright (c) 1999 Apple Computer, Inc. All rights reserved.

The contents of this file constitute Original Code as defined in and are subject to the Apple Public Source License Version 1.1 (the "License"). You may not use this file except in compliance with the License. Please obtain a copy of the License at <http://www.apple.com/publicsource> and read it before using this file.

This Original Code and all software distributed under the License are distributed on an "AS IS" basis, WITHOUT WARRANTY OF ANY KIND, EITHER EXPRESS OR IMPLIED, AND APPLE HEREBY DISCLAIMS ALL SUCH WARRANTIES, INCLUDING WITHOUT LIMITATION, ANY WARRANTIES OF MERCHANTABILITY, FITNESS FOR A PARTICULAR PURPOSE OR NON-INFRINGEMENT. Please see the License for the specific language governing rights and limitations under the License.

Copyright (c) 1992 NeXT Computer, Inc. All rights reserved.

Note: the URL <http://www.apple.com/publicsource> cited above no longer exists, see instead <https://spdx.org/licenses/APSL-1.1.html>

23.1.2. Draco

Draco

[google/draco](https://www.google.com/draco/) is licensed under the Apache License:

Licensed under the Apache License, Version 2.0 (the "License"); you may not use this file except in compliance with the License. You may obtain a copy of the License at

<http://www.apache.org/licenses/LICENSE-2.0>

Unless required by applicable law or agreed to in writing, software distributed under the License is distributed on an "AS IS" BASIS, WITHOUT WARRANTIES OR CONDITIONS OF ANY KIND, either express or implied.

See the License for the specific language governing permissions and limitations under the License.



23.1.3. Expat

Expat

Copyright (c) 1998, 1999, 2000 Thai Open Source Software Center Ltd
and Clark Cooper
Copyright (c) 2001, 2002, 2003, 2004, 2005, 2006 Expat maintainers.

Permission is hereby granted, free of charge, to any person
obtaining
a copy of this software and associated documentation files (the
"Software"), to deal in the Software without restriction, including
without limitation the rights to use, copy, modify, merge, publish,
distribute, sublicense, and/or sell copies of the Software, and to
permit persons to whom the Software is furnished to do so, subject
to
the following conditions:

The above copyright notice and this permission notice shall be
included
in all copies or substantial portions of the Software.

THE SOFTWARE IS PROVIDED "AS IS", WITHOUT WARRANTY OF ANY KIND,
EXPRESS OR IMPLIED, INCLUDING BUT NOT LIMITED TO THE WARRANTIES OF
MERCHANTABILITY, FITNESS FOR A PARTICULAR PURPOSE AND
NONINFRINGEMENT.

IN NO EVENT SHALL THE AUTHORS OR COPYRIGHT HOLDERS BE LIABLE FOR ANY
CLAIM, DAMAGES OR OTHER LIABILITY, WHETHER IN AN ACTION OF CONTRACT,
TORT OR OTHERWISE, ARISING FROM, OUT OF OR IN CONNECTION WITH THE
SOFTWARE OR THE USE OR OTHER DEALINGS IN THE SOFTWARE

23.1.4. FreeType

FreeType

Portions of this software are copyright The FreeType Project (www.freetype.org). All
rights reserved.

The FreeType Project LICENSE

2006-Jan-27

Copyright 1996-2002, 2006 by
David Turner, Robert Wilhelm, and Werner Lemberg

Introduction
=====

The FreeType Project is distributed in several archive packages;



some of them may contain, in addition to the FreeType font engine, various tools and contributions which rely on, or relate to, the FreeType Project.

This license applies to all files found in such packages, and which do not fall under their own explicit license. The license affects thus the FreeType font engine, the test programs, documentation and makefiles, at the very least.

This license was inspired by the BSD, Artistic, and IJG (Independent JPEG Group) licenses, which all encourage inclusion and use of free software in commercial and freeware products alike. As a consequence, its main points are that:

- o We don't promise that this software works. However, we will be interested in any kind of bug reports. ('as is' distribution)
- o You can use this software for whatever you want, in parts or full form, without having to pay us. ('royalty-free' usage)
- o You may not pretend that you wrote this software. If you use it, or only parts of it, in a program, you must acknowledge somewhere in your documentation that you have used the FreeType code. ('credits')

We specifically permit and encourage the inclusion of this software, with or without modifications, in commercial products. We disclaim all warranties covering The FreeType Project and assume no liability related to The FreeType Project.

Finally, many people asked us for a preferred form for a credit/disclaimer to use in compliance with this license. We thus encourage you to use the following text:

```
""  
Portions of this software are copyright <year> The FreeType  
Project (www.freetype.org). All rights reserved.  
""
```

Please replace <year> with the value from the FreeType version you actually use.

Legal Terms =====

0. Definitions -----

Throughout this license, the terms 'package', 'FreeType Project', and 'FreeType archive' refer to the set of files originally distributed by the authors (David Turner, Robert Wilhelm, and Werner Lemberg) as the 'FreeType Project', be they named as alpha, beta or final release.



`You' refers to the licensee, or person using the project, where `using' is a generic term including compiling the project's source code as well as linking it to form a `program' or `executable'. This program is referred to as `a program using the FreeType engine'.

This license applies to all files distributed in the original FreeType Project, including all source code, binaries and documentation, unless otherwise stated in the file in its original, unmodified form as distributed in the original archive. If you are unsure whether or not a particular file is covered by this license, you must contact us to verify this.

The FreeType Project is copyright (C) 1996-2000 by David Turner, Robert Wilhelm, and Werner Lemberg. All rights reserved except as specified below.

1. No Warranty

THE FREETYPE PROJECT IS PROVIDED `AS IS' WITHOUT WARRANTY OF ANY KIND, EITHER EXPRESS OR IMPLIED, INCLUDING, BUT NOT LIMITED TO, WARRANTIES OF MERCHANTABILITY AND FITNESS FOR A PARTICULAR PURPOSE. IN NO EVENT WILL ANY OF THE AUTHORS OR COPYRIGHT HOLDERS BE LIABLE FOR ANY DAMAGES CAUSED BY THE USE OR THE INABILITY TO USE, OF THE FREETYPE PROJECT.

2. Redistribution

This license grants a worldwide, royalty-free, perpetual and irrevocable right and license to use, execute, perform, compile, display, copy, create derivative works of, distribute and sublicense the FreeType Project (in both source and object code forms) and derivative works thereof for any purpose; and to authorize others to exercise some or all of the rights granted herein, subject to the following conditions:

- o Redistribution of source code must retain this license file (`FTL.TXT') unaltered; any additions, deletions or changes to the original files must be clearly indicated in accompanying documentation. The copyright notices of the unaltered, original files must be preserved in all copies of source files.
- o Redistribution in binary form must provide a disclaimer that states that the software is based in part of the work of the FreeType Team, in the distribution documentation. We also encourage you to put an URL to the FreeType web page in your documentation, though this isn't mandatory.

These conditions apply to any software derived from or based on the FreeType Project, not just the unmodified files. If you use our work, you must acknowledge us. However, no fee need be paid



to us.

3. Advertising

Neither the FreeType authors and contributors nor you shall use the name of the other for commercial, advertising, or promotional purposes without specific prior written permission.

We suggest, but do not require, that you use one or more of the following phrases to refer to this software in your documentation or advertising materials: `FreeType Project', `FreeType Engine', `FreeType library', or `FreeType Distribution'.

As you have not signed this license, you are not required to accept it. However, as the FreeType Project is copyrighted material, only this license, or another one contracted with the authors, grants you the right to use, distribute, and modify it. Therefore, by using, distributing, or modifying the FreeType Project, you indicate that you understand and accept all the terms of this license.

4. Contacts

There are two mailing lists related to FreeType:

- o `freetype@nongnu.org`

Discusses general use and applications of FreeType, as well as future and wanted additions to the library and distribution. If you are looking for support, start in this list if you haven't found anything to help you in the documentation.

- o `freetype-devel@nongnu.org`

Discusses bugs, as well as engine internals, design issues, specific licenses, porting, etc.

Our home page can be found at

<http://www.freetype.org>

--- end of FTL.TXT ---

23.1.5. FFmpeg

FFmpeg

FFmpeg is licensed under the LGPL v2.1+. The exception to this is the x264



library used by FFmpeg, for which Arup have obtained a commercial license (see [here](#)).

License

Most files in FFmpeg are under the GNU Lesser General Public License version 2.1 or later (LGPL v2.1+). Read the file `COPYING.LGPLv2.1` for details. Some other files have MIT/X11/BSD-style licenses. In combination the LGPL v2.1+ applies to FFmpeg.

Some optional parts of FFmpeg are licensed under the GNU General Public License version 2 or later (GPL v2+). See the file `COPYING.GPLv2` for details. None of these parts are used by default, you have to explicitly pass `--enable-gpl` to configure to activate them. In this case, FFmpeg's license changes to GPL v2+.

Specifically, the GPL parts of FFmpeg are:

- libpostproc
- optional x86 optimization in the files
 - `libavcodec/x86/flac_dsp_gpl.asm`
 - `libavcodec/x86/idct_mmx.c`
 - `libavfilter/x86/vf_removegrain.asm`
- the following building and testing tools
 - `compat/solaris/make_sunver.pl`
 - `doc/t2h.pm`
 - `doc/texi2pod.pl`
 - `libswresample/tests/swresample.c`
 - `tests/checkasm/*`
 - `tests/tiny_ssim.c`
- the following filters in libavfilter:
 - `signature_lookup.c`
 - `vf_blackframe.c`
 - `vf_boxblur.c`
 - `vf_colormatrix.c`
 - `vf_cover_rect.c`
 - `vf_cropdetect.c`
 - `vf_delogo.c`
 - `vf_eq.c`
 - `vf_find_rect.c`
 - `vf_fspp.c`
 - `vf_histeq.c`
 - `vf_hqdn3d.c`
 - `vf_kerndeint.c`
 - `vf_lensfun.c` (GPL version 3 or later)
 - `vf_mcdeint.c`
 - `vf_mpdecimate.c`
 - `vf_nnedi.c`



```
- `vf_owdenoise.c`  
- `vf_perspective.c`  
- `vf_phase.c`  
- `vf_pp.c`  
- `vf_pp7.c`  
- `vf_pullup.c`  
- `vf_repeatfields.c`  
- `vf_sab.c`  
- `vf_signature.c`  
- `vf_smartblur.c`  
- `vf_spp.c`  
- `vf_stereo3d.c`  
- `vf_super2xsai.c`  
- `vf_tinterlace.c`  
- `vf_uspp.c`  
- `vf_vaguedenoiser.c`  
- `vsrc_mptestsrc.c`
```

Should you, for whatever reason, prefer to use version 3 of the (L)GPL, then the configure parameter `--enable-version3` will activate this licensing option for you. Read the file `COPYING.LGPLv3` or, if you have enabled GPL parts, `COPYING.GPLv3` to learn the exact legal terms that apply in this case.

There are a handful of files under other licensing terms, namely:

- * The files `libavcodec/jfdctfst.c`, `libavcodec/jfdctint_template.c` and `libavcodec/jrevdct.c` are taken from libjpeg, see the top of the files for licensing details. Specifically note that you must credit the IJG in the documentation accompanying your program if you only distribute executables.
- You must also indicate any changes including additions and deletions to those three files in the documentation.
- * `tests/reference.pnm` is under the expat license.

External libraries

FFmpeg can be combined with a number of external libraries, which sometimes affect the licensing of binaries resulting from the combination.

Compatible libraries

The following libraries are under GPL version 2:

```
- avisynth  
- frei0r  
- libcdio
```



- libdav1s
- librubberband
- libvidstab
- libx264
- libx265
- libxavs
- libxavs2
- libxvid

When combining them with FFmpeg, FFmpeg needs to be licensed as GPL as well by passing `--enable-gpl` to configure.

The following libraries are under LGPL version 3:

- gmp
- libaribb24
- liblensfun

When combining them with FFmpeg, use the configure option `--enable-version3` to upgrade FFmpeg to the LGPL v3.

The VMAF, mbedTLS, RK MPI, OpenCORE and VisualOn libraries are under the Apache License 2.0. That license is incompatible with the LGPL v2.1 and the GPL v2, but not with version 3 of those licenses. So to combine these libraries with FFmpeg, the license version needs to be upgraded by passing `--enable-version3` to configure.

The smbclient library is under the GPL v3, to combine it with FFmpeg, the options `--enable-gpl` and `--enable-version3` have to be passed to configure to upgrade FFmpeg to the GPL v3.

Incompatible libraries

There are certain libraries you can combine with FFmpeg whose licenses are not compatible with the GPL and/or the LGPL. If you wish to enable these libraries, even in circumstances that their license may be incompatible, pass `--enable-nonfree` to configure. This will cause the resulting binary to be unredistributable.

The Fraunhofer FDK AAC and OpenSSL libraries are under licenses which are incompatible with the GPLv2 and v3. To the best of our knowledge, they are compatible with the LGPL.



23.1.6. HDF5

HDF5

Copyright Notice and License Terms for
HDF5 (Hierarchical Data Format 5) Software Library and Utilities

HDF5 (Hierarchical Data Format 5) Software Library and Utilities
Copyright 2006 by The HDF Group.

NCSA HDF5 (Hierarchical Data Format 5) Software Library and
Utilities
Copyright 1998-2006 by The Board of Trustees of the University of
Illinois.

All rights reserved.

Redistribution and use in source and binary forms, with or without
modification, are permitted for any purpose (including commercial
purposes)

provided that the following conditions are met:

1. Redistributions of source code must retain the above copyright
notice,
this list of conditions, and the following disclaimer.
2. Redistributions in binary form must reproduce the above copyright
notice,
this list of conditions, and the following disclaimer in the
documentation
and/or materials provided with the distribution.
3. Neither the name of The HDF Group, the name of the University,
nor the
name of any Contributor may be used to endorse or promote
products derived
from this software without specific prior written permission from
The HDF Group, the University, or the Contributor, respectively.

DISCLAIMER:

THIS SOFTWARE IS PROVIDED BY THE HDF GROUP AND THE CONTRIBUTORS
"AS IS" WITH NO WARRANTY OF ANY KIND, EITHER EXPRESSED OR IMPLIED.
IN NO
EVENT SHALL THE HDF GROUP OR THE CONTRIBUTORS BE LIABLE FOR ANY
DAMAGES
SUFFERED BY THE USERS ARISING OUT OF THE USE OF THIS SOFTWARE, EVEN
IF
ADVISED OF THE POSSIBILITY OF SUCH DAMAGE.

You are under no obligation whatsoever to provide any bug fixes,
patches, or



upgrades to the features, functionality or performance of the source code ("Enhancements") to anyone; however, if you choose to make your Enhancements available either publicly, or directly to The HDF Group, without imposing a separate written license agreement for such Enhancements, then you hereby grant the following license: a non-exclusive, royalty-free perpetual license to install, use, modify, prepare derivative works, incorporate into other computer software, distribute, and sublicense such enhancements or derivative works thereof, in binary and source code form.

Limited portions of HDF5 were developed by Lawrence Berkeley National Laboratory (LBNL). LBNL's Copyright Notice and Licensing Terms can be found here: COPYING_LBNL_HDF5 file in this directory or at http://support.hdfgroup.org/ftp/HDF5/releases/COPYING_LBNL_HDF5.

Contributors: National Center for Supercomputing Applications (NCSA) at the University of Illinois, Fortner Software, Unidata Program Center (netCDF), The Independent JPEG Group (JPEG), Jean-loup Gailly and Mark Adler (gzip), and Digital Equipment Corporation (DEC).

Portions of HDF5 were developed with support from the Lawrence Berkeley National Laboratory (LBNL) and the United States Department of Energy under Prime Contract No. DE-AC02-05CH11231.

Portions of HDF5 were developed with support from the University of California, Lawrence Livermore National Laboratory (UC LLNL).



The following statement applies to those portions of the product and must be retained in any redistribution of source code, binaries, documentation, and/or accompanying materials:

This work was partially produced at the University of California, Lawrence Livermore National Laboratory (UC LLNL) under contract no. W-7405-ENG-48 (Contract 48) between the U.S. Department of Energy (DOE) and The Regents of the University of California (University) for the operation of UC LLNL.

DISCLAIMER:
THIS WORK WAS PREPARED AS AN ACCOUNT OF WORK SPONSORED BY AN AGENCY OF THE UNITED STATES GOVERNMENT. NEITHER THE UNITED STATES GOVERNMENT NOR THE UNIVERSITY OF CALIFORNIA NOR ANY OF THEIR EMPLOYEES, MAKES ANY WARRANTY, EXPRESS OR IMPLIED, OR ASSUMES ANY LIABILITY OR RESPONSIBILITY FOR THE ACCURACY, COMPLETENESS, OR USEFULNESS OF ANY INFORMATION, APPARATUS, PRODUCT, OR PROCESS DISCLOSED, OR REPRESENTS THAT ITS USE WOULD NOT INFRINGE PRIVATELY- OWNED RIGHTS. REFERENCE HEREIN TO ANY SPECIFIC COMMERCIAL PRODUCTS, PROCESS, OR SERVICE BY TRADE NAME, TRADEMARK, MANUFACTURER, OR OTHERWISE, DOES NOT NECESSARILY CONSTITUTE OR IMPLY ITS ENDORSEMENT, RECOMMENDATION, OR FAVORING BY THE UNITED STATES GOVERNMENT OR THE UNIVERSITY OF CALIFORNIA. THE VIEWS AND OPINIONS OF AUTHORS EXPRESSED HEREIN DO NOT NECESSARILY STATE OR REFLECT THOSE OF THE UNITED STATES GOVERNMENT OR THE UNIVERSITY OF CALIFORNIA, AND SHALL NOT BE USED FOR ADVERTISING OR PRODUCT ENDORSEMENT PURPOSES.

23.1.7. Jpeg

Jpeg

The authors make NO WARRANTY or representation, either express or implied, with respect to this software, its quality, accuracy, merchantability, or fitness for a particular purpose. This software is provided "AS IS", and you,



its user, assume the entire risk as to its quality and accuracy.

This software is copyright (C) 1991-2012, Thomas G. Lane, Guido Vollbeding.

All Rights Reserved except as specified below.

Permission is hereby granted to use, copy, modify, and distribute this software (or portions thereof) for any purpose, without fee, subject to these conditions:

(1) If any part of the source code for this software is distributed, then this

README file must be included, with this copyright and no-warranty notice

unaltered; and any additions, deletions, or changes to the original files

must be clearly indicated in accompanying documentation.

(2) If only executable code is distributed, then the accompanying documentation must state that "this software is based in part on the work of

the Independent JPEG Group".

(3) Permission for use of this software is granted only if the user accepts

full responsibility for any undesirable consequences; the authors accept

NO LIABILITY for damages of any kind.

These conditions apply to any software derived from or based on the IJG code,

not just to the unmodified library. If you use our work, you ought to

acknowledge us.

Permission is NOT granted for the use of any IJG author's name or company name

in advertising or publicity relating to this software or products derived from

it. This software may be referred to only as "the Independent JPEG Group's

software".

We specifically permit and encourage the use of this software as the basis of

commercial products, provided that all warranty or liability claims are

assumed by the product vendor.



23.1.8. Libchardet

Libchardet

MOZILLA PUBLIC LICENSE
Version 1.1

1. Definitions.

1.0.1. "Commercial Use" means distribution or otherwise making the Covered Code available to a third party.

1.1. "Contributor" means each entity that creates or contributes to the creation of Modifications.

1.2. "Contributor Version" means the combination of the Original Code, prior Modifications used by a Contributor, and the Modifications made by that particular Contributor.

1.3. "Covered Code" means the Original Code or Modifications or the combination of the Original Code and Modifications, in each case including portions thereof.

1.4. "Electronic Distribution Mechanism" means a mechanism generally accepted in the software development community for the electronic transfer of data.

1.5. "Executable" means Covered Code in any form other than Source Code.

1.6. "Initial Developer" means the individual or entity identified as the Initial Developer in the Source Code notice required by Exhibit A.

1.7. "Larger Work" means a work which combines Covered Code or portions thereof with code not governed by the terms of this License.

1.8. "License" means this document.

1.8.1. "Licensable" means having the right to grant, to the maximum extent possible, whether at the time of the initial grant or subsequently acquired, any and all of the rights conveyed herein.

1.9. "Modifications" means any addition to or deletion from the substance or structure of either the Original Code or any previous Modifications. When Covered Code is released as a series of files, a Modification is:

A. Any addition to or deletion from the contents of a file containing Original Code or previous Modifications.



B. Any new file that contains any part of the Original Code or previous Modifications.

1.10. "Original Code" means Source Code of computer software code which is described in the Source Code notice required by Exhibit A as Original Code, and which, at the time of its release under this License is not already Covered Code governed by this License.

1.10.1. "Patent Claims" means any patent claim(s), now owned or hereafter acquired, including without limitation, method, process, and apparatus claims, in any patent Licensable by grantor.

1.11. "Source Code" means the preferred form of the Covered Code for making modifications to it, including all modules it contains, plus any associated interface definition files, scripts used to control compilation and installation of an Executable, or source code differential comparisons against either the Original Code or another well known, available Covered Code of the Contributor's choice. The Source Code can be in a compressed or archival form, provided the appropriate decompression or de-archiving software is widely available for no charge.

1.12. "You" (or "Your") means an individual or a legal entity exercising rights under, and complying with all of the terms of, this License or a future version of this License issued under Section 6.1. For legal entities, "You" includes any entity which controls, is controlled by, or is under common control with You. For purposes of this definition, "control" means (a) the power, direct or indirect, to cause the direction or management of such entity, whether by contract or otherwise, or (b) ownership of more than fifty percent (50%) of the outstanding shares or beneficial ownership of such entity.

2. Source Code License.

2.1. The Initial Developer Grant.

The Initial Developer hereby grants You a world-wide, royalty-free, non-exclusive license, subject to third party intellectual property claims:

(a) under intellectual property rights (other than patent or trademark) Licensable by Initial Developer to use, reproduce, modify, display, perform, sublicense and distribute the Original Code (or portions thereof) with or without Modifications, and/or as part of a Larger Work; and

(b) under Patents Claims infringed by the making, using or selling of Original Code, to make, have made, use, practice, sell, and offer for sale, and/or otherwise dispose of the Original Code (or portions thereof).

(c) the licenses granted in this Section 2.1(a) and (b) are effective on the date Initial Developer first distributes Original Code under the terms of this License.



(d) Notwithstanding Section 2.1(b) above, no patent license is granted: 1) for code that You delete from the Original Code; 2) separate from the Original Code; or 3) for infringements caused by: i) the modification of the Original Code or ii) the combination of the Original Code with other software or devices.

2.2. Contributor Grant.

Subject to third party intellectual property claims, each Contributor hereby grants You a world-wide, royalty-free, non-exclusive license

(a) under intellectual property rights (other than patent or trademark) Licensable by Contributor, to use, reproduce, modify, display, perform, sublicense and distribute the Modifications created by such Contributor (or portions thereof) either on an unmodified basis, with other Modifications, as Covered Code and/or as part of a Larger Work; and

(b) under Patent Claims infringed by the making, using, or selling of Modifications made by that Contributor either alone and/or in combination with its Contributor Version (or portions of such combination), to make, use, sell, offer for sale, have made, and/or otherwise dispose of: 1) Modifications made by that Contributor (or portions thereof); and 2) the combination of Modifications made by that Contributor with its Contributor Version (or portions of such combination).

(c) the licenses granted in Sections 2.2(a) and 2.2(b) are effective on the date Contributor first makes Commercial Use of the Covered Code.

(d) Notwithstanding Section 2.2(b) above, no patent license is granted: 1) for any code that Contributor has deleted from the Contributor Version; 2) separate from the Contributor Version; 3) for infringements caused by: i) third party modifications of Contributor Version or ii) the combination of Modifications made by that Contributor with other software (except as part of the Contributor Version) or other devices; or 4) under Patent Claims infringed by Covered Code in the absence of Modifications made by that Contributor.

3. Distribution Obligations.

3.1. Application of License.

The Modifications which You create or to which You contribute are governed by the terms of this License, including without limitation Section 2.2. The Source Code version of Covered Code may be distributed only under the terms of this License or a future version of this License released under Section 6.1, and You must include a copy of this License with every copy of the Source Code You distribute. You may not offer or impose any terms on any Source Code version that alters or restricts the applicable version of this License or the recipients' rights hereunder. However, You may include an additional document offering the additional rights described in



Section 3.5.

3.2. Availability of Source Code.

Any Modification which You create or to which You contribute must be made available in Source Code form under the terms of this License either on the same media as an Executable version or via an accepted Electronic Distribution Mechanism to anyone to whom you made an Executable version available; and if made available via Electronic Distribution Mechanism, must remain available for at least twelve (12) months after the date it initially became available, or at least six (6) months after a subsequent version of that particular Modification has been made available to such recipients. You are responsible for ensuring that the Source Code version remains available even if the Electronic Distribution Mechanism is maintained by a third party.

3.3. Description of Modifications.

You must cause all Covered Code to which You contribute to contain a file documenting the changes You made to create that Covered Code and the date of any change. You must include a prominent statement that the Modification is derived, directly or indirectly, from Original Code provided by the Initial Developer and including the name of the Initial Developer in (a) the Source Code, and (b) in any notice in an Executable version or related documentation in which You describe the origin or ownership of the Covered Code.

3.4. Intellectual Property Matters

(a) Third Party Claims.

If Contributor has knowledge that a license under a third party's intellectual property rights is required to exercise the rights granted by such Contributor under Sections 2.1 or 2.2, Contributor must include a text file with the Source Code distribution titled "LEGAL" which describes the claim and the party making the claim in sufficient detail that a recipient will know whom to contact. If Contributor obtains such knowledge after the Modification is made available as described in Section 3.2, Contributor shall promptly modify the LEGAL file in all copies Contributor makes available thereafter and shall take other steps (such as notifying appropriate mailing lists or newsgroups) reasonably calculated to inform those who received the Covered Code that new knowledge has been obtained.

(b) Contributor APIs.

If Contributor's Modifications include an application programming interface and Contributor has knowledge of patent licenses which are reasonably necessary to implement that API, Contributor must also include this information in the LEGAL file.

(c) Representations.

Contributor represents that, except as disclosed pursuant to Section 3.4(a) above, Contributor believes that Contributor's Modifications are Contributor's original creation(s) and/or Contributor has sufficient rights to grant the rights conveyed by this License.



3.5. Required Notices.

You must duplicate the notice in Exhibit A in each file of the Source Code. If it is not possible to put such notice in a particular Source Code file due to its structure, then You must include such notice in a location (such as a relevant directory) where a user would be likely to look for such a notice. If You created one or more Modification(s) You may add your name as a Contributor to the notice described in Exhibit A. You must also duplicate this License in any documentation for the Source Code where You describe recipients' rights or ownership rights relating to Covered Code. You may choose to offer, and to charge a fee for, warranty, support, indemnity or liability obligations to one or more recipients of Covered Code. However, You may do so only on Your own behalf, and not on behalf of the Initial Developer or any Contributor. You must make it absolutely clear than any such warranty, support, indemnity or liability obligation is offered by You alone, and You hereby agree to indemnify the Initial Developer and every Contributor for any liability incurred by the Initial Developer or such Contributor as a result of warranty, support, indemnity or liability terms You offer.

3.6. Distribution of Executable Versions.

You may distribute Covered Code in Executable form only if the requirements of Section 3.1-3.5 have been met for that Covered Code, and if You include a notice stating that the Source Code version of the Covered Code is available under the terms of this License, including a description of how and where You have fulfilled the obligations of Section 3.2. The notice must be conspicuously included in any notice in an Executable version, related documentation or collateral in which You describe recipients' rights relating to the Covered Code. You may distribute the Executable version of Covered Code or ownership rights under a license of Your choice, which may contain terms different from this License, provided that You are in compliance with the terms of this License and that the license for the Executable version does not attempt to limit or alter the recipient's rights in the Source Code version from the rights set forth in this License. If You distribute the Executable version under a different license You must make it absolutely clear that any terms which differ from this License are offered by You alone, not by the Initial Developer or any Contributor. You hereby agree to indemnify the Initial Developer and every Contributor for any liability incurred by the Initial Developer or such Contributor as a result of any such terms You offer.

3.7. Larger Works.

You may create a Larger Work by combining Covered Code with other code not governed by the terms of this License and distribute the Larger Work as a single product. In such a case, You must make sure the requirements of this License are fulfilled for the Covered Code.

4. Inability to Comply Due to Statute or Regulation.

If it is impossible for You to comply with any of the terms of this License with respect to some or all of the Covered Code due to statute, judicial order, or regulation then You must: (a) comply with the terms of this License to the maximum extent possible; and (b)



describe the limitations and the code they affect. Such description must be included in the LEGAL file described in Section 3.4 and must be included with all distributions of the Source Code. Except to the extent prohibited by statute or regulation, such description must be sufficiently detailed for a recipient of ordinary skill to be able to understand it.

5. Application of this License.

This License applies to code to which the Initial Developer has attached the notice in Exhibit A and to related Covered Code.

6. Versions of the License.

6.1. New Versions.

Netscape Communications Corporation ("Netscape") may publish revised and/or new versions of the License from time to time. Each version will be given a distinguishing version number.

6.2. Effect of New Versions.

Once Covered Code has been published under a particular version of the License, You may always continue to use it under the terms of that version. You may also choose to use such Covered Code under the terms of any subsequent version of the License published by Netscape. No one other than Netscape has the right to modify the terms applicable to Covered Code created under this License.

6.3. Derivative Works.

If You create or use a modified version of this License (which you may only do in order to apply it to code which is not already Covered Code governed by this License), You must (a) rename Your license so that the phrases "Mozilla", "MOZILLAPL", "MOZPL", "Netscape", "MPL", "NPL" or any confusingly similar phrase do not appear in your license (except to note that your license differs from this License) and (b) otherwise make it clear that Your version of the license contains terms which differ from the Mozilla Public License and Netscape Public License. (Filling in the name of the Initial Developer, Original Code or Contributor in the notice described in Exhibit A shall not of themselves be deemed to be modifications of this License.)

7. DISCLAIMER OF WARRANTY.

COVERED CODE IS PROVIDED UNDER THIS LICENSE ON AN "AS IS" BASIS, WITHOUT WARRANTY OF ANY KIND, EITHER EXPRESSED OR IMPLIED, INCLUDING, WITHOUT LIMITATION, WARRANTIES THAT THE COVERED CODE IS FREE OF DEFECTS, MERCHANTABILITY, FIT FOR A PARTICULAR PURPOSE OR NON-INFRINGEMENT.

THE ENTIRE RISK AS TO THE QUALITY AND PERFORMANCE OF THE COVERED CODE

IS WITH YOU. SHOULD ANY COVERED CODE PROVE DEFECTIVE IN ANY RESPECT, YOU (NOT THE INITIAL DEVELOPER OR ANY OTHER CONTRIBUTOR) ASSUME THE COST OF ANY NECESSARY SERVICING, REPAIR OR CORRECTION. THIS DISCLAIMER



OF WARRANTY CONSTITUTES AN ESSENTIAL PART OF THIS LICENSE. NO USE OF ANY COVERED CODE IS AUTHORIZED HEREUNDER EXCEPT UNDER THIS DISCLAIMER.

8. TERMINATION.

8.1. This License and the rights granted hereunder will terminate automatically if You fail to comply with terms herein and fail to cure such breach within 30 days of becoming aware of the breach. All sublicenses to the Covered Code which are properly granted shall survive any termination of this License. Provisions which, by their nature, must remain in effect beyond the termination of this License shall survive.

8.2. If You initiate litigation by asserting a patent infringement claim (excluding declaratory judgment actions) against Initial Developer or a Contributor (the Initial Developer or Contributor against whom You file such action is referred to as "Participant") alleging that:

(a) such Participant's Contributor Version directly or indirectly infringes any patent, then any and all rights granted by such Participant to You under Sections 2.1 and/or 2.2 of this License shall, upon 60 days notice from Participant terminate prospectively, unless if within 60 days after receipt of notice You either: (i) agree in writing to pay Participant a mutually agreeable reasonable royalty for Your past and future use of Modifications made by such Participant, or (ii) withdraw Your litigation claim with respect to the Contributor Version against such Participant. If within 60 days of notice, a reasonable royalty and payment arrangement are not mutually agreed upon in writing by the parties or the litigation claim is not withdrawn, the rights granted by Participant to You under Sections 2.1 and/or 2.2 automatically terminate at the expiration of the 60 day notice period specified above.

(b) any software, hardware, or device, other than such Participant's Contributor Version, directly or indirectly infringes any patent, then any rights granted to You by such Participant under Sections 2.1(b) and 2.2(b) are revoked effective as of the date You first made, used, sold, distributed, or had made, Modifications made by that Participant.

8.3. If You assert a patent infringement claim against Participant alleging that such Participant's Contributor Version directly or indirectly infringes any patent where such claim is resolved (such as by license or settlement) prior to the initiation of patent infringement litigation, then the reasonable value of the licenses granted by such Participant under Sections 2.1 or 2.2 shall be taken into account in determining the amount or value of any payment or license.

8.4. In the event of termination under Sections 8.1 or 8.2 above, all end user license agreements (excluding distributors and resellers) which have been validly granted by You or any distributor hereunder prior to termination shall survive termination.



9. LIMITATION OF LIABILITY.

UNDER NO CIRCUMSTANCES AND UNDER NO LEGAL THEORY, WHETHER TORT (INCLUDING NEGLIGENCE), CONTRACT, OR OTHERWISE, SHALL YOU, THE INITIAL DEVELOPER, ANY OTHER CONTRIBUTOR, OR ANY DISTRIBUTOR OF COVERED CODE, OR ANY SUPPLIER OF ANY OF SUCH PARTIES, BE LIABLE TO ANY PERSON FOR ANY INDIRECT, SPECIAL, INCIDENTAL, OR CONSEQUENTIAL DAMAGES OF ANY CHARACTER INCLUDING, WITHOUT LIMITATION, DAMAGES FOR LOSS OF GOODWILL, WORK STOPPAGE, COMPUTER FAILURE OR MALFUNCTION, OR ANY AND ALL OTHER COMMERCIAL DAMAGES OR LOSSES, EVEN IF SUCH PARTY SHALL HAVE BEEN INFORMED OF THE POSSIBILITY OF SUCH DAMAGES. THIS LIMITATION OF LIABILITY SHALL NOT APPLY TO LIABILITY FOR DEATH OR PERSONAL INJURY RESULTING FROM SUCH PARTY'S NEGLIGENCE TO THE EXTENT APPLICABLE LAW PROHIBITS SUCH LIMITATION. SOME JURISDICTIONS DO NOT ALLOW THE EXCLUSION OR LIMITATION OF INCIDENTAL OR CONSEQUENTIAL DAMAGES, SO THIS EXCLUSION AND LIMITATION MAY NOT APPLY TO YOU.

10. U.S. GOVERNMENT END USERS.

The Covered Code is a "commercial item," as that term is defined in 48 C.F.R. 2.101 (Oct. 1995), consisting of "commercial computer software" and "commercial computer software documentation," as such terms are used in 48 C.F.R. 12.212 (Sept. 1995). Consistent with 48 C.F.R. 12.212 and 48 C.F.R. 227.7202-1 through 227.7202-4 (June 1995), all U.S. Government End Users acquire Covered Code with only those rights set forth herein.

11. MISCELLANEOUS.

This License represents the complete agreement concerning subject matter hereof. If any provision of this License is held to be unenforceable, such provision shall be reformed only to the extent necessary to make it enforceable. This License shall be governed by California law provisions (except to the extent applicable law, if any, provides otherwise), excluding its conflict-of-law provisions. With respect to disputes in which at least one party is a citizen of, or an entity chartered or registered to do business in the United States of America, any litigation relating to this License shall be subject to the jurisdiction of the Federal Courts of the Northern District of California, with venue lying in Santa Clara County, California, with the losing party responsible for costs, including without limitation, court costs and reasonable attorneys' fees and expenses. The application of the United Nations Convention on Contracts for the International Sale of Goods is expressly excluded. Any law or regulation which provides that the language of a contract shall be construed against the drafter shall not apply to this License.

12. RESPONSIBILITY FOR CLAIMS.



As between Initial Developer and the Contributors, each party is responsible for claims and damages arising, directly or indirectly, out of its utilization of rights under this License and You agree to work with Initial Developer and Contributors to distribute such responsibility on an equitable basis. Nothing herein is intended or shall be deemed to constitute any admission of liability.

13. MULTIPLE-LICENSED CODE.

Initial Developer may designate portions of the Covered Code as "Multiple-Licensed". "Multiple-Licensed" means that the Initial Developer permits you to utilize portions of the Covered Code under Your choice of the NPL or the alternative licenses, if any, specified by the Initial Developer in the file described in Exhibit A.

EXHIBIT A -Mozilla Public License.

``The contents of this file are subject to the Mozilla Public License Version 1.1 (the "License"); you may not use this file except in compliance with the License. You may obtain a copy of the License at <http://www.mozilla.org/MPL/>

Software distributed under the License is distributed on an "AS IS" basis, WITHOUT WARRANTY OF ANY KIND, either express or implied. See the License for the specific language governing rights and limitations under the License.

23.1.9. Libcurl

Libcurl

COPYRIGHT AND PERMISSION NOTICE

Copyright (c) 1996 - 2012, Daniel Stenberg, <daniel@haxx.se>.

All rights reserved.

Permission to use, copy, modify, and distribute this software for any purpose with or without fee is hereby granted, provided that the above copyright notice and this permission notice appear in all copies.

THE SOFTWARE IS PROVIDED "AS IS", WITHOUT WARRANTY OF ANY KIND, EXPRESS OR IMPLIED, INCLUDING BUT NOT LIMITED TO THE WARRANTIES OF MERCHANTABILITY, FITNESS FOR A PARTICULAR PURPOSE AND NONINFRINGEMENT OF THIRD PARTY RIGHTS. IN



NO EVENT SHALL THE AUTHORS OR COPYRIGHT HOLDERS BE LIABLE FOR ANY CLAIM, DAMAGES OR OTHER LIABILITY, WHETHER IN AN ACTION OF CONTRACT, TORT OR OTHERWISE, ARISING FROM, OUT OF OR IN CONNECTION WITH THE SOFTWARE OR THE USE OR OTHER DEALINGS IN THE SOFTWARE.

Except as contained in this notice, the name of a copyright holder shall not be used in advertising or otherwise to promote the sale, use or other dealings in this Software without prior written authorization of the copyright holder.

23.1.10. Libgif

Libgif

The GIFLIB distribution is Copyright (c) 1997 Eric S. Raymond

Permission is hereby granted, free of charge, to any person obtaining a copy of this software and associated documentation files (the "Software"), to deal in the Software without restriction, including without limitation the rights to use, copy, modify, merge, publish, distribute, sublicense, and/or sell copies of the Software, and to permit persons to whom the Software is furnished to do so, subject to the following conditions:

The above copyright notice and this permission notice shall be included in all copies or substantial portions of the Software.

THE SOFTWARE IS PROVIDED "AS IS", WITHOUT WARRANTY OF ANY KIND, EXPRESS OR IMPLIED, INCLUDING BUT NOT LIMITED TO THE WARRANTIES OF MERCHANTABILITY, FITNESS FOR A PARTICULAR PURPOSE AND NONINFRINGEMENT. IN NO EVENT SHALL THE AUTHORS OR COPYRIGHT HOLDERS BE LIABLE FOR ANY CLAIM, DAMAGES OR OTHER LIABILITY, WHETHER IN AN ACTION OF CONTRACT, TORT OR OTHERWISE, ARISING FROM, OUT OF OR IN CONNECTION WITH THE SOFTWARE OR THE USE OR OTHER DEALINGS IN THE SOFTWARE.



23.1.11. Libopc

Libopc

Copyright (c) 2010/2011, Florian Reuter
All rights reserved.

Redistribution and use in source and binary forms, with or without modification, are permitted provided that the following conditions are met:

- * Redistributions of source code must retain the above copyright notice, this list of conditions and the following disclaimer.
- * Redistributions in binary form must reproduce the above copyright notice, this list of conditions and the following disclaimer in the documentation and/or other materials provided with the distribution.
- * Neither the name of Florian Reuter nor the names of its contributors may be used to endorse or promote products derived from this software without specific prior written permission.

THIS SOFTWARE IS PROVIDED BY THE COPYRIGHT HOLDERS AND CONTRIBUTORS "AS IS" AND ANY EXPRESS OR IMPLIED WARRANTIES, INCLUDING, BUT NOT LIMITED TO, THE IMPLIED WARRANTIES OF MERCHANTABILITY AND FITNESS FOR A PARTICULAR PURPOSE ARE DISCLAIMED. IN NO EVENT SHALL THE COPYRIGHT OWNER OR CONTRIBUTORS BE LIABLE FOR ANY DIRECT, INDIRECT, INCIDENTAL, SPECIAL, EXEMPLARY, OR CONSEQUENTIAL DAMAGES (INCLUDING, BUT NOT LIMITED TO, PROCUREMENT OF SUBSTITUTE GOODS OR SERVICES; LOSS OF USE, DATA, OR PROFITS; OR BUSINESS INTERRUPTION) HOWEVER CAUSED AND ON ANY THEORY OF LIABILITY, WHETHER IN CONTRACT, STRICT LIABILITY, OR TORT (INCLUDING NEGLIGENCE OR OTHERWISE) ARISING IN ANY WAY OUT OF THE USE OF THIS SOFTWARE, EVEN IF ADVISED OF THE POSSIBILITY OF SUCH DAMAGE.

23.1.12. Libpng

Libpng

COPYRIGHT NOTICE, DISCLAIMER, and LICENSE

=====

PNG Reference Library License version 2

- * Copyright (c) 1995-2019 The PNG Reference Library Authors.
- * Copyright (c) 2018-2019 Cosmin Truta.
- * Copyright (c) 2000-2002, 2004, 2006-2018 Glenn Randers-Pehrson.
- * Copyright (c) 1996-1997 Andreas Dilger.



* Copyright (c) 1995-1996 Guy Eric Schalnat, Group 42, Inc.

The software is supplied "as is", without warranty of any kind, express or implied, including, without limitation, the warranties of merchantability, fitness for a particular purpose, title, and non-infringement. In no event shall the Copyright owners, or anyone distributing the software, be liable for any damages or other liability, whether in contract, tort or otherwise, arising from, out of, or in connection with the software, or the use or other dealings in the software, even if advised of the possibility of such damage.

Permission is hereby granted to use, copy, modify, and distribute this software, or portions hereof, for any purpose, without fee, subject to the following restrictions:

1. The origin of this software must not be misrepresented; you must not claim that you wrote the original software. If you use this software in a product, an acknowledgment in the product documentation would be appreciated, but is not required.
2. Altered source versions must be plainly marked as such, and must not be misrepresented as being the original software.
3. This Copyright notice may not be removed or altered from any source or altered source distribution.

PNG Reference Library License version 1 (for libpng 0.5 through 1.6.35)

libpng versions 1.0.7, July 1, 2000, through 1.6.35, July 15, 2018 are

Copyright (c) 2000-2002, 2004, 2006-2018 Glenn Randers-Pehrson, are derived from libpng-1.0.6, and are distributed according to the same disclaimer and license as libpng-1.0.6 with the following individuals

added to the list of Contributing Authors:

Simon-Pierre Cadieux
Eric S. Raymond
Mans Rullgard
Cosmin Truta
Gilles Vollant
James Yu
Mandar Sahastrabudde
Google Inc.
Vadim Barkov

and with the following additions to the disclaimer:

There is no warranty against interference with your enjoyment of



the library or against infringement. There is no warranty that our efforts or the library will fulfill any of your particular purposes or needs. This library is provided with all faults, and the entire risk of satisfactory quality, performance, accuracy, and effort is with the user.

Some files in the "contrib" directory and some configure-generated files that are distributed with libpng have other copyright owners, and are released under other open source licenses.

libpng versions 0.97, January 1998, through 1.0.6, March 20, 2000, are Copyright (c) 1998-2000 Glenn Randers-Pehrson, are derived from libpng-0.96, and are distributed according to the same disclaimer and license as libpng-0.96, with the following individuals added to the list of Contributing Authors:

Tom Lane
Glenn Randers-Pehrson
Willem van Schaik

libpng versions 0.89, June 1996, through 0.96, May 1997, are Copyright (c) 1996-1997 Andreas Dilger, are derived from libpng-0.88, and are distributed according to the same disclaimer and license as libpng-0.88, with the following individuals added to the list of Contributing Authors:

John Bowler
Kevin Bracey
Sam Bushell
Magnus Holmgren
Greg Roelofs
Tom Tanner

Some files in the "scripts" directory have other copyright owners, but are released under this license.

libpng versions 0.5, May 1995, through 0.88, January 1996, are Copyright (c) 1995-1996 Guy Eric Schalnat, Group 42, Inc.

For the purposes of this copyright and license, "Contributing Authors" is defined as the following set of individuals:

Andreas Dilger
Dave Martindale
Guy Eric Schalnat
Paul Schmidt



Tim Wegner

The PNG Reference Library is supplied "AS IS". The Contributing Authors and Group 42, Inc. disclaim all warranties, expressed or implied, including, without limitation, the warranties of merchantability and of fitness for any purpose. The Contributing Authors and Group 42, Inc. assume no liability for direct, indirect, incidental, special, exemplary, or consequential damages, which may result from the use of the PNG Reference Library, even if advised of the possibility of such damage.

Permission is hereby granted to use, copy, modify, and distribute this source code, or portions hereof, for any purpose, without fee, subject to the following restrictions:

1. The origin of this source code must not be misrepresented.
2. Altered versions must be plainly marked as such and must not be misrepresented as being the original source.
3. This Copyright notice may not be removed or altered from any source or altered source distribution.

The Contributing Authors and Group 42, Inc. specifically permit, without fee, and encourage the use of this source code as a component to supporting the PNG file format in commercial products. If you use this source code in a product, acknowledgment is not required but would be appreciated.

23.1.13. Libxlsxwriter

Libxlsxwriter

Libxlsxwriter is released under a FreeBSD license:

Copyright 2014-2016, John McNamara
All rights reserved.

Redistribution and use in source and binary forms, with or without modification, are permitted provided that the following conditions are met:

1. Redistributions of source code must retain the above copyright notice, this list of conditions and the following disclaimer.
2. Redistributions in binary form must reproduce the above copyright



notice, this list of conditions and the following disclaimer in the documentation and/or other materials provided with the distribution.

THIS SOFTWARE IS PROVIDED BY THE COPYRIGHT HOLDERS AND CONTRIBUTORS "AS IS" AND ANY EXPRESS OR IMPLIED WARRANTIES, INCLUDING, BUT NOT LIMITED TO, THE IMPLIED WARRANTIES OF MERCHANTABILITY AND FITNESS FOR A PARTICULAR PURPOSE ARE DISCLAIMED. IN NO EVENT SHALL THE COPYRIGHT OWNER OR CONTRIBUTORS BE LIABLE FOR ANY DIRECT, INDIRECT, INCIDENTAL, SPECIAL, EXEMPLARY, OR CONSEQUENTIAL DAMAGES (INCLUDING, BUT NOT LIMITED TO, PROCUREMENT OF SUBSTITUTE GOODS OR SERVICES; LOSS OF USE, DATA, OR PROFITS; OR BUSINESS INTERRUPTION) HOWEVER CAUSED AND ON ANY THEORY OF LIABILITY, WHETHER IN CONTRACT, STRICT LIABILITY, OR TORT (INCLUDING NEGLIGENCE OR OTHERWISE) ARISING IN ANY WAY OUT OF THE USE OF THIS SOFTWARE, EVEN IF ADVISED OF THE POSSIBILITY OF SUCH DAMAGE.

The views and conclusions contained in the software and documentation are those of the authors and should not be interpreted as representing official policies, either expressed or implied, of the FreeBSD Project.

Libxlsxwriter includes `queue.h` from FreeBSD and the `minizip` component of `zlib` which have the following licenses:

Queue.h from FreeBSD:

Copyright (c) 1991, 1993
The Regents of the University of California. All rights reserved.

Redistribution and use in source and binary forms, with or without modification, are permitted provided that the following conditions are met:

1. Redistributions of source code must retain the above copyright notice, this list of conditions and the following disclaimer.
2. Redistributions in binary form must reproduce the above copyright



notice, this list of conditions and the following disclaimer in the documentation and/or other materials provided with the distribution.

4. Neither the name of the University nor the names of its contributors may be used to endorse or promote products derived from this software without specific prior written permission.

THIS SOFTWARE IS PROVIDED BY THE REGENTS AND CONTRIBUTORS ``AS IS'' AND ANY EXPRESS OR IMPLIED WARRANTIES, INCLUDING, BUT NOT LIMITED TO, THE IMPLIED WARRANTIES OF MERCHANTABILITY AND FITNESS FOR A PARTICULAR PURPOSE ARE DISCLAIMED. IN NO EVENT SHALL THE REGENTS OR CONTRIBUTORS BE LIABLE FOR ANY DIRECT, INDIRECT, INCIDENTAL, SPECIAL, EXEMPLARY, OR CONSEQUENTIAL DAMAGES (INCLUDING, BUT NOT LIMITED TO, PROCUREMENT OF SUBSTITUTE GOODS OR SERVICES; LOSS OF USE, DATA, OR PROFITS; OR BUSINESS INTERRUPTION) HOWEVER CAUSED AND ON ANY THEORY OF LIABILITY, WHETHER IN CONTRACT, STRICT LIABILITY, OR TORT (INCLUDING NEGLIGENCE OR OTHERWISE) ARISING IN ANY WAY OUT OF THE USE OF THIS SOFTWARE, EVEN IF ADVISED OF THE POSSIBILITY OF SUCH DAMAGE.

Zlib has the following License/Copyright:

(C) 1995-2013 Jean-loup Gailly and Mark Adler

This software is provided 'as-is', without any express or implied warranty. In no event will the authors be held liable for any damages arising from the use of this software.

Permission is granted to anyone to use this software for any purpose, including commercial applications, and to alter it and redistribute it freely, subject to the following restrictions:

1. The origin of this software must not be misrepresented; you must not claim that you wrote the original software. If you use this software in a product, an acknowledgment in the product documentation would be



appreciated but is not required.

2. Altered source versions must be plainly marked as such, and must not be

misrepresented as being the original software.

3. This notice may not be removed or altered from any source distribution.

Jean-loup Gailly
jloup@gzip.org

Mark Adler
madler@alumni.caltech.edu



23.1.14. Libxml2

Libxml2

Except where otherwise noted in the source code (e.g. the files dict.c and list.c, which are covered by a similar licence but with different Copyright notices) all the files are:

Copyright (C) 1998-2012 Daniel Veillard. All Rights Reserved.
Copyright (C) The Libxml2 Contributors.

Permission is hereby granted, free of charge, to any person obtaining a copy of this software and associated documentation files (the "Software"), to deal in the Software without restriction, including without limitation the rights to use, copy, modify, merge, publish, distribute, sublicense, and/or sell copies of the Software, and to permit persons to whom the Software is furnished to do so, subject to the following conditions:

The above copyright notice and this permission notice shall be included in all copies or substantial portions of the Software.

THE SOFTWARE IS PROVIDED "AS IS", WITHOUT WARRANTY OF ANY KIND, EXPRESS OR IMPLIED, INCLUDING BUT NOT LIMITED TO THE WARRANTIES OF MERCHANTABILITY, FITNESS FOR A PARTICULAR PURPOSE AND NONINFRINGEMENT. IN NO EVENT SHALL THE AUTHORS OR COPYRIGHT HOLDERS BE LIABLE FOR ANY CLAIM, DAMAGES OR OTHER LIABILITY, WHETHER IN AN ACTION OF CONTRACT, TORT OR OTHERWISE, ARISING FROM, OUT OF OR IN CONNECTION WITH THE SOFTWARE OR THE USE OR OTHER DEALINGS IN THE SOFTWARE.



23.1.15. Libzip

Libzip

libzip is released under a 3-clause BSD license:

Copyright (C) 1999-2022 Dieter Baron and Thomas Klausner

The authors can be contacted at info@libzip.org

Redistribution and use in source and binary forms, with or without modification, are permitted provided that the following conditions are met:

1. Redistributions of source code must retain the above copyright notice, this list of conditions and the following disclaimer.
2. Redistributions in binary form must reproduce the above copyright notice, this list of conditions and the following disclaimer in the documentation and/or other materials provided with the distribution.
3. The names of the authors may not be used to endorse or promote products derived from this software without specific prior written permission.

THIS SOFTWARE IS PROVIDED BY THE AUTHORS "AS IS" AND ANY EXPRESS OR IMPLIED WARRANTIES, INCLUDING, BUT NOT LIMITED TO, THE IMPLIED WARRANTIES OF MERCHANTABILITY AND FITNESS FOR A PARTICULAR PURPOSE ARE DISCLAIMED. IN NO EVENT SHALL THE AUTHORS BE LIABLE FOR ANY DIRECT, INDIRECT, INCIDENTAL, SPECIAL, EXEMPLARY, OR CONSEQUENTIAL DAMAGES (INCLUDING, BUT NOT LIMITED TO, PROCUREMENT OF SUBSTITUTE GOODS OR SERVICES; LOSS OF USE, DATA, OR PROFITS; OR BUSINESS INTERRUPTION) HOWEVER CAUSED AND ON ANY THEORY OF LIABILITY, WHETHER IN CONTRACT, STRICT LIABILITY, OR TORT (INCLUDING NEGLIGENCE OR OTHERWISE) ARISING IN ANY WAY OUT OF THE USE OF THIS SOFTWARE, EVEN IF ADVISED OF THE POSSIBILITY OF SUCH DAMAGE.

23.1.16. Openssl

Openssl

LICENSE ISSUES

=====

The OpenSSL toolkit stays under a double license, i.e. both the conditions of the OpenSSL License and the original SSLeay license apply to the toolkit.

See below for the actual license texts.

OpenSSL License

/*

=====



```
* Copyright (c) 1998-2017 The OpenSSL Project. All rights
reserved.
*
* Redistribution and use in source and binary forms, with or
without
* modification, are permitted provided that the following
conditions
* are met:
*
* 1. Redistributions of source code must retain the above copyright
* notice, this list of conditions and the following disclaimer.
*
* 2. Redistributions in binary form must reproduce the above
copyright
* notice, this list of conditions and the following disclaimer
in
* the documentation and/or other materials provided with the
* distribution.
*
* 3. All advertising materials mentioning features or use of this
* software must display the following acknowledgment:
* "This product includes software developed by the OpenSSL
Project
* for use in the OpenSSL Toolkit. (http://www.openssl.org/)"
*
* 4. The names "OpenSSL Toolkit" and "OpenSSL Project" must not be
used to
* endorse or promote products derived from this software without
* prior written permission. For written permission, please
contact
* openssl-core@openssl.org.
*
* 5. Products derived from this software may not be called
"OpenSSL"
* nor may "OpenSSL" appear in their names without prior written
* permission of the OpenSSL Project.
*
* 6. Redistributions of any form whatsoever must retain the
following
* acknowledgment:
* "This product includes software developed by the OpenSSL
Project
* for use in the OpenSSL Toolkit (http://www.openssl.org/)"
*
* THIS SOFTWARE IS PROVIDED BY THE OpenSSL PROJECT ``AS IS'' AND
ANY
* EXPRESSED OR IMPLIED WARRANTIES, INCLUDING, BUT NOT LIMITED TO,
THE
* IMPLIED WARRANTIES OF MERCHANTABILITY AND FITNESS FOR A
PARTICULAR
* PURPOSE ARE DISCLAIMED. IN NO EVENT SHALL THE OpenSSL PROJECT OR
* ITS CONTRIBUTORS BE LIABLE FOR ANY DIRECT, INDIRECT, INCIDENTAL,
* SPECIAL, EXEMPLARY, OR CONSEQUENTIAL DAMAGES (INCLUDING, BUT
* NOT LIMITED TO, PROCUREMENT OF SUBSTITUTE GOODS OR SERVICES;
* LOSS OF USE, DATA, OR PROFITS; OR BUSINESS INTERRUPTION)
```



```
* HOWEVER CAUSED AND ON ANY THEORY OF LIABILITY, WHETHER IN
CONTRACT,
* STRICT LIABILITY, OR TORT (INCLUDING NEGLIGENCE OR OTHERWISE)
* ARISING IN ANY WAY OUT OF THE USE OF THIS SOFTWARE, EVEN IF
ADVISED
* OF THE POSSIBILITY OF SUCH DAMAGE.
*
```

```
=====
```

```
*
* This product includes cryptographic software written by Eric
Young
* (eay@cryptsoft.com). This product includes software written by
Tim
* Hudson (tjh@cryptsoft.com).
*
*/
```

```
Original SSLeay License
-----
```

```
/* Copyright (C) 1995-1998 Eric Young (eay@cryptsoft.com)
* All rights reserved.
*
* This package is an SSL implementation written
* by Eric Young (eay@cryptsoft.com).
* The implementation was written so as to conform with Netscapes
SSL.
*
* This library is free for commercial and non-commercial use as
long as
* the following conditions are aheared to. The following
conditions
* apply to all code found in this distribution, be it the RC4, RSA,
* lhash, DES, etc., code; not just the SSL code. The SSL
documentation
* included with this distribution is covered by the same copyright
terms
* except that the holder is Tim Hudson (tjh@cryptsoft.com).
*
* Copyright remains Eric Young's, and as such any Copyright notices
in
* the code are not to be removed.
* If this package is used in a product, Eric Young should be given
attribution
* as the author of the parts of the library used.
* This can be in the form of a textual message at program startup
or
* in documentation (online or textual) provided with the package.
*
* Redistribution and use in source and binary forms, with or
without
* modification, are permitted provided that the following
conditions
* are met:
* 1. Redistributions of source code must retain the copyright
```



```
* notice, this list of conditions and the following disclaimer.
* 2. Redistributions in binary form must reproduce the above
copyright
* notice, this list of conditions and the following disclaimer
in the
* documentation and/or other materials provided with the
distribution.
* 3. All advertising materials mentioning features or use of this
software
* must display the following acknowledgement:
* "This product includes cryptographic software written by
* Eric Young (eay@cryptsoft.com)"
* The word 'cryptographic' can be left out if the routines from
the library
* being used are not cryptographic related :-).
* 4. If you include any Windows specific code (or a derivative
thereof) from
* the apps directory (application code) you must include an
acknowledgement:
* "This product includes software written by Tim Hudson
(tjh@cryptsoft.com)"
*
* THIS SOFTWARE IS PROVIDED BY ERIC YOUNG ``AS IS'' AND
* ANY EXPRESS OR IMPLIED WARRANTIES, INCLUDING, BUT NOT LIMITED TO,
THE
* IMPLIED WARRANTIES OF MERCHANTABILITY AND FITNESS FOR A
PARTICULAR PURPOSE
* ARE DISCLAIMED. IN NO EVENT SHALL THE AUTHOR OR CONTRIBUTORS BE
LIABLE
* FOR ANY DIRECT, INDIRECT, INCIDENTAL, SPECIAL, EXEMPLARY, OR
CONSEQUENTIAL
* DAMAGES (INCLUDING, BUT NOT LIMITED TO, PROCUREMENT OF SUBSTITUTE
GOODS
* OR SERVICES; LOSS OF USE, DATA, OR PROFITS; OR BUSINESS
INTERRUPTION)
* HOWEVER CAUSED AND ON ANY THEORY OF LIABILITY, WHETHER IN
CONTRACT, STRICT
* LIABILITY, OR TORT (INCLUDING NEGLIGENCE OR OTHERWISE) ARISING IN
ANY WAY
* OUT OF THE USE OF THIS SOFTWARE, EVEN IF ADVISED OF THE
POSSIBILITY OF
* SUCH DAMAGE.
*
* The licence and distribution terms for any publically available
version or
* derivative of this code cannot be changed. i.e. this code cannot
simply be
* copied and put under another distribution licence
* [including the GNU Public Licence.]
*/
```



23.1.17. PCRE2

PCRE2

PCRE2 LICENCE

PCRE2 is a library of functions to support regular expressions whose syntax and semantics are as close as possible to those of the Perl 5 language.

Releases 10.00 and above of PCRE2 are distributed under the terms of the "BSD" licence, as specified below, with one exemption for certain binary redistributions. The documentation for PCRE2, supplied in the "doc" directory, is distributed under the same terms as the software itself. The data in the testdata directory is not copyrighted and is in the public domain.

The basic library functions are written in C and are freestanding. Also included in the distribution is a just-in-time compiler that can be used to optimize pattern matching. This is an optional feature that can be omitted when the library is built.

THE BASIC LIBRARY FUNCTIONS

Written by: Philip Hazel
Email local part: ph10
Email domain: cam.ac.uk

University of Cambridge Computing Service,
Cambridge, England.

Copyright (c) 1997-2018 University of Cambridge
All rights reserved.

PCRE2 JUST-IN-TIME COMPILATION SUPPORT

Written by: Zoltan Herczeg
Email local part: hzmester
Email domain: freemail.hu

Copyright(c) 2010-2018 Zoltan Herczeg
All rights reserved.



STACK-LESS JUST-IN-TIME COMPILER

Written by: Zoltan Herczeg
Email local part: hzmester
Email domain: freemail.hu

Copyright(c) 2009-2018 Zoltan Herczeg
All rights reserved.

THE "BSD" LICENCE

Redistribution and use in source and binary forms, with or without modification, are permitted provided that the following conditions are met:

- * Redistributions of source code must retain the above copyright notices,

 - this list of conditions and the following disclaimer.

- * Redistributions in binary form must reproduce the above copyright

 - notices, this list of conditions and the following disclaimer in the

 - documentation and/or other materials provided with the distribution.

- * Neither the name of the University of Cambridge nor the names of any

 - contributors may be used to endorse or promote products derived from this

 - software without specific prior written permission.

THIS SOFTWARE IS PROVIDED BY THE COPYRIGHT HOLDERS AND CONTRIBUTORS "AS IS"

AND ANY EXPRESS OR IMPLIED WARRANTIES, INCLUDING, BUT NOT LIMITED TO, THE

IMPLIED WARRANTIES OF MERCHANTABILITY AND FITNESS FOR A PARTICULAR PURPOSE

ARE DISCLAIMED. IN NO EVENT SHALL THE COPYRIGHT OWNER OR CONTRIBUTORS BE

LIABLE FOR ANY DIRECT, INDIRECT, INCIDENTAL, SPECIAL, EXEMPLARY, OR CONSEQUENTIAL DAMAGES (INCLUDING, BUT NOT LIMITED TO, PROCUREMENT OF SUBSTITUTE GOODS OR SERVICES; LOSS OF USE, DATA, OR PROFITS; OR BUSINESS

INTERRUPTION) HOWEVER CAUSED AND ON ANY THEORY OF LIABILITY, WHETHER IN

CONTRACT, STRICT LIABILITY, OR TORT (INCLUDING NEGLIGENCE OR OTHERWISE)

ARISING IN ANY WAY OUT OF THE USE OF THIS SOFTWARE, EVEN IF ADVISED OF THE

POSSIBILITY OF SUCH DAMAGE.



EXEMPTION FOR BINARY LIBRARY-LIKE PACKAGES

The second condition in the BSD licence (covering binary redistributions) does not apply all the way down a chain of software. If binary package A includes PCRE2, it must respect the condition, but if package B is software that includes package A, the condition is not imposed on package B unless it uses PCRE2 independently.

End

23.1.18. PDFHummus

PDFHummus

Is licensed under the Apache License:

Copyright 2011 Gal Kahana PDFWriter

Licensed under the Apache License, Version 2.0 (the "License"); you may not use this file except in compliance with the License. You may obtain a copy of the License at

<http://www.apache.org/licenses/LICENSE-2.0>

Unless required by applicable law or agreed to in writing, software distributed under the License is distributed on an "AS IS" BASIS, WITHOUT WARRANTIES OR CONDITIONS OF ANY KIND, either express or implied.

See the License for the specific language governing permissions and limitations under the License.



23.1.19. Schemasafe

The MIT License (MIT)

Copyright (c) 2014 Mathias Buus
Copyright (c) 2020 Exodus Movement

Permission is hereby granted, free of charge, to any person obtaining a copy of this software and associated documentation files (the "Software"), to deal in the Software without restriction, including without limitation the rights to use, copy, modify, merge, publish, distribute, sublicense, and/or sell copies of the Software, and to permit persons to whom the Software is furnished to do so, subject to the following conditions:

The above copyright notice and this permission notice shall be included in all copies or substantial portions of the Software.

THE SOFTWARE IS PROVIDED "AS IS", WITHOUT WARRANTY OF ANY KIND, EXPRESS OR IMPLIED, INCLUDING BUT NOT LIMITED TO THE WARRANTIES OF MERCHANTABILITY, FITNESS FOR A PARTICULAR PURPOSE AND NONINFRINGEMENT. IN NO EVENT SHALL THE AUTHORS OR COPYRIGHT HOLDERS BE LIABLE FOR ANY CLAIM, DAMAGES OR OTHER LIABILITY, WHETHER IN AN ACTION OF CONTRACT, TORT OR OTHERWISE, ARISING FROM, OUT OF OR IN CONNECTION WITH THE SOFTWARE OR THE USE OR OTHER DEALINGS IN THE SOFTWARE.

23.1.20. SmoothSort

SmoothSort

Is licensed under the Creative Commons Attribution-ShareAlike 3.0 license which may be found here:

<https://creativecommons.org/licenses/by-sa/3.0/legalcode>

Oasys Ltd acknowledge Wikibooks as the source of this algorithm, which is used in unmodified form.

23.1.21. Spidermonkey

Spidermonkey



Mozilla Public License Version 2.0
=====

1. Definitions

1.1. "Contributor"

means each individual or legal entity that creates, contributes to the creation of, or owns Covered Software.

1.2. "Contributor Version"

means the combination of the Contributions of others (if any) used by a Contributor and that particular Contributor's Contribution.

1.3. "Contribution"

means Covered Software of a particular Contributor.

1.4. "Covered Software"

means Source Code Form to which the initial Contributor has attached the notice in Exhibit A, the Executable Form of such Source Code Form, and Modifications of such Source Code Form, in each case including portions thereof.

1.5. "Incompatible With Secondary Licenses"

means

(a) that the initial Contributor has attached the notice described

in Exhibit B to the Covered Software; or

(b) that the Covered Software was made available under the terms of

version 1.1 or earlier of the License, but not also under the

terms of a Secondary License.

1.6. "Executable Form"

means any form of the work other than Source Code Form.

1.7. "Larger Work"

means a work that combines Covered Software with other material, in

a separate file or files, that is not Covered Software.

1.8. "License"

means this document.

1.9. "Licensable"

means having the right to grant, to the maximum extent possible, whether at the time of the initial grant or subsequently, any and

all of the rights conveyed by this License.



1.10. "Modifications"

means any of the following:

- (a) any file in Source Code Form that results from an addition to,
deletion from, or modification of the contents of Covered Software; or
- (b) any new file in Source Code Form that contains any Covered Software.

1.11. "Patent Claims" of a Contributor

means any patent claim(s), including without limitation, method, process, and apparatus claims, in any patent Licensable by such Contributor that would be infringed, but for the grant of the License, by the making, using, selling, offering for sale, having made, import, or transfer of either its Contributions or its Contributor Version.

1.12. "Secondary License"

means either the GNU General Public License, Version 2.0, the GNU Lesser General Public License, Version 2.1, the GNU Affero General Public License, Version 3.0, or any later versions of those licenses.

1.13. "Source Code Form"

means the form of the work preferred for making modifications.

1.14. "You" (or "Your")

means an individual or a legal entity exercising rights under this License. For legal entities, "You" includes any entity that controls, is controlled by, or is under common control with You. For purposes of this definition, "control" means (a) the power, direct or indirect, to cause the direction or management of such entity, whether by contract or otherwise, or (b) ownership of more than fifty percent (50%) of the outstanding shares or beneficial ownership of such entity.

2. License Grants and Conditions

2.1. Grants

Each Contributor hereby grants You a world-wide, royalty-free, non-exclusive license:



(a) under intellectual property rights (other than patent or trademark)

Licensable by such Contributor to use, reproduce, make available, modify, display, perform, distribute, and otherwise exploit its Contributions, either on an unmodified basis, with Modifications, or as part of a Larger Work; and

(b) under Patent Claims of such Contributor to make, use, sell, offer

for sale, have made, import, and otherwise transfer either its Contributions or its Contributor Version.

2.2. Effective Date

The licenses granted in Section 2.1 with respect to any Contribution become effective for each Contribution on the date the Contributor first distributes such Contribution.

2.3. Limitations on Grant Scope

The licenses granted in this Section 2 are the only rights granted under this License. No additional rights or licenses will be implied from the distribution or licensing of Covered Software under this License. Notwithstanding Section 2.1(b) above, no patent license is granted by a Contributor:

(a) for any code that a Contributor has removed from Covered Software;
or

(b) for infringements caused by: (i) Your and any other third party's modifications of Covered Software, or (ii) the combination of its Contributions with other software (except as part of its Contributor Version); or

(c) under Patent Claims infringed by Covered Software in the absence of its Contributions.

This License does not grant any rights in the trademarks, service marks, or logos of any Contributor (except as may be necessary to comply with the notice requirements in Section 3.4).

2.4. Subsequent Licenses



No Contributor makes additional grants as a result of Your choice to distribute the Covered Software under a subsequent version of this License (see Section 10.2) or under the terms of a Secondary License (if permitted under the terms of Section 3.3).

2.5. Representation

Each Contributor represents that the Contributor believes its Contributions are its original creation(s) or it has sufficient rights to grant the rights to its Contributions conveyed by this License.

2.6. Fair Use

This License is not intended to limit any rights You have under applicable copyright doctrines of fair use, fair dealing, or other equivalents.

2.7. Conditions

Sections 3.1, 3.2, 3.3, and 3.4 are conditions of the licenses granted in Section 2.1.

3. Responsibilities

3.1. Distribution of Source Form

All distribution of Covered Software in Source Code Form, including any Modifications that You create or to which You contribute, must be under the terms of this License. You must inform recipients that the Source Code Form of the Covered Software is governed by the terms of this License, and how they can obtain a copy of this License. You may not attempt to alter or restrict the recipients' rights in the Source Code Form.

3.2. Distribution of Executable Form

If You distribute Covered Software in Executable Form then:

- (a) such Covered Software must also be made available in Source Code Form, as described in Section 3.1, and You must inform recipients of the Executable Form how they can obtain a copy of such Source Code Form by reasonable means in a timely manner, at a charge no more than the cost of distribution to the recipient; and



(b) You may distribute such Executable Form under the terms of this License, or sublicense it under different terms, provided that the license for the Executable Form does not attempt to limit or alter the recipients' rights in the Source Code Form under this License.

3.3. Distribution of a Larger Work

You may create and distribute a Larger Work under terms of Your choice, provided that You also comply with the requirements of this License for the Covered Software. If the Larger Work is a combination of Covered Software with a work governed by one or more Secondary Licenses, and the Covered Software is not Incompatible With Secondary Licenses, this License permits You to additionally distribute such Covered Software under the terms of such Secondary License(s), so that the recipient of the Larger Work may, at their option, further distribute the Covered Software under the terms of either this License or such Secondary License(s).

3.4. Notices

You may not remove or alter the substance of any license notices (including copyright notices, patent notices, disclaimers of warranty, or limitations of liability) contained within the Source Code Form of the Covered Software, except that You may alter any license notices to the extent required to remedy known factual inaccuracies.

3.5. Application of Additional Terms

You may choose to offer, and to charge a fee for, warranty, support, indemnity or liability obligations to one or more recipients of Covered Software. However, You may do so only on Your own behalf, and not on behalf of any Contributor. You must make it absolutely clear that any such warranty, support, indemnity, or liability obligation is offered by You alone, and You hereby agree to indemnify every Contributor for any liability incurred by such Contributor as a result of warranty, support, indemnity or liability terms You offer. You may include additional disclaimers of warranty and limitations of liability specific to any jurisdiction.

4. Inability to Comply Due to Statute or Regulation



If it is impossible for You to comply with any of the terms of this License with respect to some or all of the Covered Software due to statute, judicial order, or regulation then You must: (a) comply with the terms of this License to the maximum extent possible; and (b) describe the limitations and the code they affect. Such description must be placed in a text file included with all distributions of the Covered Software under this License. Except to the extent prohibited by statute or regulation, such description must be sufficiently detailed for a recipient of ordinary skill to be able to understand it.

5. Termination

5.1. The rights granted under this License will terminate automatically if You fail to comply with any of its terms. However, if You become compliant, then the rights granted under this License from a particular Contributor are reinstated (a) provisionally, unless and until such Contributor explicitly and finally terminates Your grants, and (b) on an ongoing basis, if such Contributor fails to notify You of the non-compliance by some reasonable means prior to 60 days after You have come back into compliance. Moreover, Your grants from a particular Contributor are reinstated on an ongoing basis if such Contributor notifies You of the non-compliance by some reasonable means, this is the first time You have received notice of non-compliance with this License from such Contributor, and You become compliant prior to 30 days after Your receipt of the notice.

5.2. If You initiate litigation against any entity by asserting a patent infringement claim (excluding declaratory judgment actions, counter-claims, and cross-claims) alleging that a Contributor Version directly or indirectly infringes any patent, then the rights granted to You by any and all Contributors for the Covered Software under Section 2.1 of this License shall terminate.

5.3. In the event of termination under Sections 5.1 or 5.2 above, all end user license agreements (excluding distributors and resellers) which



have been validly granted by You or Your distributors under this License prior to termination shall survive termination.

*
*
* 6. Disclaimer of Warranty
*
* -----

* Covered Software is provided under this License on an "as is"
* basis, without warranty of any kind, either expressed, implied,
or *
* statutory, including, without limitation, warranties that the
* Covered Software is free of defects, merchantable, fit for a
* particular purpose or non-infringing. The entire risk as to the
* quality and performance of the Covered Software is with You.
* Should any Covered Software prove defective in any respect, You
* (not any Contributor) assume the cost of any necessary servicing,
* repair, or correction. This disclaimer of warranty constitutes an
* essential part of this License. No use of any Covered Software is
* authorized under this License except under this disclaimer.

*
*
* 7. Limitation of Liability
*
* -----

* Under no circumstances and under no legal theory, whether tort
* (including negligence), contract, or otherwise, shall any
*



* Contributor, or anyone who distributes Covered Software as
 * permitted above, be liable to You for any direct, indirect,
 * special, incidental, or consequential damages of any character
 * including, without limitation, damages for lost profits, loss of
 * goodwill, work stoppage, computer failure or malfunction, or any
 * and all other commercial damages or losses, even if such party
 * shall have been informed of the possibility of such damages. This
 * limitation of liability shall not apply to liability for death or
 * personal injury resulting from such party's negligence to the
 * extent applicable law prohibits such limitation. Some
 * jurisdictions do not allow the exclusion or limitation of
 * incidental or consequential damages, so this exclusion and
 * limitation may not apply to You.

8. Litigation

Any litigation relating to this License may be brought only in the courts of a jurisdiction where the defendant maintains its principal place of business and such litigation shall be governed by laws of that jurisdiction, without reference to its conflict-of-law provisions. Nothing in this Section shall prevent a party's ability to bring cross-claims or counter-claims.

9. Miscellaneous

This License represents the complete agreement concerning the subject matter hereof. If any provision of this License is held to be unenforceable, such provision shall be reformed only to the extent necessary to make it enforceable. Any law or regulation which provides that the language of a contract shall be construed against the drafter shall not be used to construe this License against a Contributor.



10. Versions of the License

10.1. New Versions

Mozilla Foundation is the license steward. Except as provided in Section

10.3, no one other than the license steward has the right to modify or

publish new versions of this License. Each version will be given a distinguishing version number.

10.2. Effect of New Versions

You may distribute the Covered Software under the terms of the version

of the License under which You originally received the Covered Software,

or under the terms of any subsequent version published by the license steward.

10.3. Modified Versions

If you create software not governed by this License, and you want to create a new license for such software, you may create and use a modified version of this License if you rename the license and remove

any references to the name of the license steward (except to note that

such modified license differs from this License).

10.4. Distributing Source Code Form that is Incompatible With Secondary Licenses

If You choose to distribute Source Code Form that is Incompatible With

Secondary Licenses under the terms of this version of the License, the

notice described in Exhibit B of this License must be attached.

Exhibit A - Source Code Form License Notice

This Source Code Form is subject to the terms of the Mozilla Public

License, v. 2.0. If a copy of the MPL was not distributed with this

file, You can obtain one at <http://mozilla.org/MPL/2.0/>.

If it is not possible or desirable to put the notice in a particular file, then You may include the notice in a location (such as a LICENSE



file in a relevant directory) where a recipient would be likely to look for such a notice.

You may add additional accurate notices of copyright ownership.

Exhibit B - "Incompatible With Secondary Licenses" Notice

This Source Code Form is "Incompatible With Secondary Licenses", as defined by the Mozilla Public License, v. 2.0.



23.1.22. SQLite

SQLite

SQLite Is Public Domain

All of the code and documentation in SQLite has been dedicated to the [public domain](#) by the authors. All code authors, and representatives of the companies they work for, have signed affidavits dedicating their contributions to the public domain and originals of those signed affidavits are stored in a firesafe at the main offices of [Hwaci](#). All contributors are citizens of countries that allow creative works to be dedicated into the public domain. Anyone is free to copy, modify, publish, use, compile, sell, or distribute the original SQLite code, either in source code form or as a compiled binary, for any purpose, commercial or non-commercial, and by any means.

The previous paragraph applies to the deliverable code and documentation in SQLite - those parts of the SQLite library that you actually bundle and ship with a larger application. Some scripts used as part of the build process (for example the "configure" scripts generated by autoconf) might fall under other open-source licenses. Nothing from these build scripts ever reaches the final deliverable SQLite library, however, and so the licenses associated with those scripts should not be a factor in assessing your rights to copy and use the SQLite library.

All of the deliverable code in SQLite has been written from scratch. No code has been taken from other projects or from the open internet. Every line of code can be traced back to its original author, and all of those authors have public domain dedications on file. So the SQLite code base is clean and is uncontaminated with licensed code from other projects.

Open-Source, not Open-Contribution

SQLite is open-source, meaning that you can make as many copies of it as you want and do whatever you want with those copies, without limitation. But SQLite is not open-contribution. In order to keep SQLite in the public domain and ensure that the code does not become contaminated with proprietary or licensed content, the project does not accept patches from people who have not submitted an affidavit dedicating their contribution into the public domain.

All of the code in SQLite is original, having been written specifically for use by SQLite. No code has been copied from unknown sources on the internet.

Warranty of Title

SQLite is in the public domain and does not require a license. Even so, some organizations want legal proof of their right to use SQLite. Circumstances where this might occur include the following:

- Your company desires indemnity against claims of copyright infringement.
- You are using SQLite in a jurisdiction that does not recognize the public domain.
- You are using SQLite in a jurisdiction that does not recognize the right of an author to dedicate their work to the public domain.



- You want to hold a tangible legal document as evidence that you have the legal right to use and distribute SQLite.
- Your legal department tells you that you must purchase a license.

If any of the above circumstances apply to you, [Hwaci](#), the company that employs all the developers of SQLite, will [sell you a Warranty of Title for SQLite](#). A Warranty of Title is a legal document that asserts that the claimed authors of SQLite are the true authors, and that the authors have the legal right to dedicate the SQLite library into the public domain, and that Hwaci will vigorously defend against challenges to those claims. All proceeds from the sale of SQLite Warranties of Title are used to fund continuing improvement and support of SQLite.

Contributed Code

In order to keep SQLite completely free and unencumbered by copyright, the project does not accept patches. If you would like to suggest a change and you include a patch as a proof-of-concept, that would be great. However, please do not be offended if we rewrite your patch from scratch.



23.1.23. TOML Parser for C

TOML Parser for C

MIT License

Copyright (c) CK Tan
<https://github.com/cktan/tomlc99>

Permission is hereby granted, free of charge, to any person obtaining a copy of this software and associated documentation files (the "Software"), to deal in the Software without restriction, including without limitation the rights to use, copy, modify, merge, publish, distribute, sublicense, and/or sell copies of the Software, and to permit persons to whom the Software is furnished to do so, subject to the following conditions:

The above copyright notice and this permission notice shall be included in all copies or substantial portions of the Software.

THE SOFTWARE IS PROVIDED "AS IS", WITHOUT WARRANTY OF ANY KIND, EXPRESS OR IMPLIED, INCLUDING BUT NOT LIMITED TO THE WARRANTIES OF MERCHANTABILITY, FITNESS FOR A PARTICULAR PURPOSE AND NONINFRINGEMENT. IN NO EVENT SHALL THE AUTHORS OR COPYRIGHT HOLDERS BE LIABLE FOR ANY CLAIM, DAMAGES OR OTHER LIABILITY, WHETHER IN AN ACTION OF CONTRACT, TORT OR OTHERWISE, ARISING FROM, OUT OF OR IN CONNECTION WITH THE SOFTWARE OR THE USE OR OTHER DEALINGS IN THE SOFTWARE.

23.1.24. Treeview

Treeview

Copyright (C) 2006 Conor O'Mahony (gubusoft@gubusoft.com)

All rights reserved.

This application includes the TreeView script.

You are not authorized to download and/or use the TreeView source code from this



application for your own purposes. For your own FREE copy of the TreeView script, please visit the <http://www.treeview.net> Web site.

THIS SOFTWARE IS PROVIDED "AS IS" AND WITHOUT ANY EXPRESS OR IMPLIED WARRANTIES, INCLUDING, WITHOUT LIMITATION, THE IMPLIED WARRANTIES OF MERCHANTABILITY AND FITNESS FOR A PARTICULAR PURPOSE.

If Customer is using the free version of SOFTWARE, Customer must ensure that the "JavaScript Tree Menu" link at the top of the TreeView is visible and readable in their Web page or application.

Customer may not harm the GUBUSOFT intellectual property rights using any media or via any electronic or other method now known or later discovered.

Customer may not use the GubuSoft name, the name of the TreeView author, or the names of any source code contributors to endorse or promote products derived from this SOFTWARE without specific prior written permission.

Customer may not utilize the SOFTWARE in a manner which is disparaging to GUBUSOFT.



23.1.25. Turf

Turf

The MIT License (MIT)

Copyright (c) 2019 Morgan Herlocker

Permission is hereby granted, free of charge, to any person obtaining a copy of this software and associated documentation files (the "Software"), to deal in the Software without restriction, including without limitation the rights to use, copy, modify, merge, publish, distribute, sublicense, and/or sell copies of the Software, and to permit persons to whom the Software is furnished to do so, subject to the following conditions:

The above copyright notice and this permission notice shall be included in all copies or substantial portions of the Software.

THE SOFTWARE IS PROVIDED "AS IS", WITHOUT WARRANTY OF ANY KIND, EXPRESS OR IMPLIED, INCLUDING BUT NOT LIMITED TO THE WARRANTIES OF MERCHANTABILITY, FITNESS FOR A PARTICULAR PURPOSE AND NONINFRINGEMENT. IN NO EVENT SHALL THE AUTHORS OR COPYRIGHT HOLDERS BE LIABLE FOR ANY CLAIM, DAMAGES OR OTHER LIABILITY, WHETHER IN AN ACTION OF CONTRACT, TORT OR OTHERWISE, ARISING FROM, OUT OF OR IN CONNECTION WITH THE SOFTWARE OR THE USE OR OTHER DEALINGS IN THE SOFTWARE.

23.1.26. Win-iconv

Win-iconv

win_iconv is a iconv implementation using Win32 API to convert.

win_iconv is placed in the public domain.

Yukihiro Nakadaira <yukihiro.nakadaira@gmail.com>

23.1.27. Zlib

Zlib



(C) 1995-2013 Jean-loup Gailly and Mark Adler

This software is provided 'as-is', without any express or implied warranty. In no event will the authors be held liable for any damages arising from the use of this software.

Permission is granted to anyone to use this software for any purpose, including commercial applications, and to alter it and redistribute it freely, subject to the following restrictions:

1. The origin of this software must not be misrepresented; you must not claim that you wrote the original software. If you use this software in a product, an acknowledgment in the product documentation would be appreciated but is not required.
2. Altered source versions must be plainly marked as such, and must not be misrepresented as being the original software.
3. This notice may not be removed or altered from any source distribution.

Jean-loup Gailly
jloup@gzip.org

Mark Adler
madler@alumni.caltech.edu



23.2. Other

23.2.1. MPEG-LA

MPEG-LA

THIS PRODUCT IS LICENSED UNDER THE AVC PATENT PORTFOLIO LICENSE FOR THE PERSONAL USE OF A CONSUMER OR OTHER USES IN WHICH IT DOES NOT RECEIVE REMUNERATION TO (i) ENCODE VIDEO IN COMPLIANCE WITH THE AVC STANDARD ("AVC VIDEO") AND/OR (ii) DECODE AVC VIDEO THAT WAS ENCODED BY A CONSUMER ENGAGED IN A PERSONAL ACTIVITY AND/OR WAS OBTAINED FROM A VIDEO PROVIDER LICENSED TO PROVIDE AVC VIDEO. NO LICENSE IS GRANTED OR SHALL BE IMPLIED FOR ANY OTHER USE. ADDITIONAL INFORMATION MAY BE OBTAINED FROM MPEG LA, L.L.C. SEE [HTTP://WWW.MPEGLA.COM](http://www.mpegla.com)

23.2.2. x264

x264

The x264 software library is used under commercial license from x264, LLC



23.3. Acknowledgements

23.3.1. POV-Ray

POV-Ray

POV-Ray is the "Persistence of Vision" Ray Tracing software package. Oasys LS-DYNA Environment can export files for this and use it to produce ray-traced images. We wish to acknowledge the efforts of the custodians of the software and thank them for making it freely available, enabling us to provide this capability.

POV-Ray is freeware that is licensed under the GNU AFFERO GENERAL PUBLIC LICENSE Version 3, 19 November 2007 which may be found here <http://www.povray.org/povlegal.html>. This grants "unlimited permission to run the unmodified program" so there are no restrictions placed on users.

However that licence places certain restrictions on software which might embed it or use its source code, also on its redistribution, therefore :

- Oasys LS-DYNA Environment does not contain POV-Ray or any part of it, rather it can run it in unmodified form as a standalone executable.
- Oasys LS-DYNA Environment software release bundle does not contain POV-Ray, users need to download and install it for themselves.

The POV-Ray home page is <http://www.povray.org/> where you can find information about the tracer itself, its licensing, download links and also online documentation.